

# *Coatings of* Polymers and Plastics

---

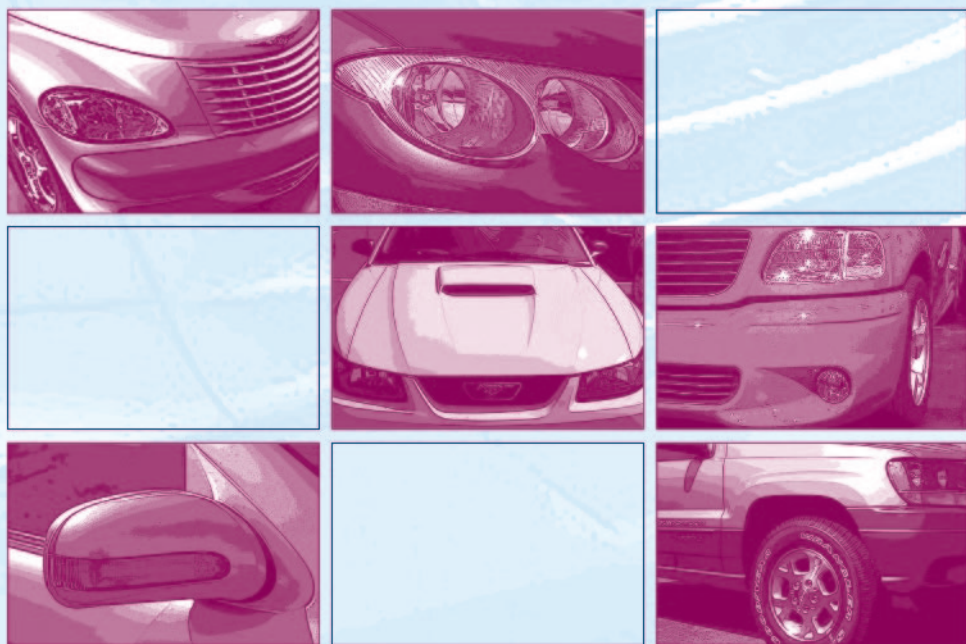

edited by

---

Rose A. Ryntz • Philip V. Yaneff

*Coatings of*

---

Polymers and  
Plastics

edited by

Rose A. Ryntz  
*Visteon Corporation*  
*Dearborn, Michigan, U.S.A.*

Philip V. Yaneff  
*DuPont Performance Coatings*  
*Ajax, Ontario, Canada*



MARCEL DEKKER, INC.

NEW YORK • BASEL

**Library of Congress Cataloging-in-Publication Data**

A catalog record for this book is available from the Library of Congress.

**ISBN: 0-8247-0894-6**

This book is printed on acid-free paper.

**Headquarters**

Marcel Dekker, Inc.  
270 Madison Avenue, New York, NY 10016  
tel: 212-696-9000; fax: 212-685-4540

**Eastern Hemisphere Distribution**

Marcel Dekker AG  
Hutgasse 4, Postfach 812, CH-4001 Basel, Switzerland  
tel: 41-61-260-6300; fax: 41-61-260-6333

**World Wide Web**

<http://www.dekker.com>

The publisher offers discounts on this book when ordered in bulk quantities. For more information, write to Special Sales/Professional Marketing at the headquarters address above.

**Copyright © 2003 by Marcel Dekker, Inc. All Rights Reserved.**

Neither this book nor any part may be reproduced or transmitted in any form or by any means, electronic or mechanical, including photocopying, microfilming, and recording, or by any information storage and retrieval system, without permission in writing from the publisher.

Current printing (last digit):

10 9 8 7 6 5 4 3 2 1

**PRINTED IN THE UNITED STATES OF AMERICA**

## MATERIALS ENGINEERING

1. Modern Ceramic Engineering: Properties, Processing, and Use in Design: Second Edition, Revised and Expanded, *David W. Richerson*
2. Introduction to Engineering Materials: Behavior, Properties, and Selection, *G. T. Murray*
3. Rapidly Solidified Alloys: Processes • Structures • Applications, *edited by Howard H. Liebermann*
4. Fiber and Whisker Reinforced Ceramics for Structural Applications, *David Belitskus*
5. Thermal Analysis of Materials, *Robert F. Speyer*
6. Friction and Wear of Ceramics, *edited by Said Jahanmir*
7. Mechanical Properties of Metallic Composites, *edited by Shojiro Ochiai*
8. Chemical Processing of Ceramics, *edited by Burtrand I. Lee and Edward J. A. Pope*
9. Handbook of Advanced Materials Testing, *edited by Nicholas P. Cheremisinoff and Paul N. Cheremisinoff*
10. Ceramic Processing and Sintering, *M. N. Rahaman*
11. Composites Engineering Handbook, *edited by P. K. Mallick*
12. Porosity of Ceramics, *Roy W. Rice*
13. Intermetallic and Ceramic Coatings, *edited by Narendra B. Dahotre and T. S. Sudarshan*
14. Adhesion Promotion Techniques: Technological Applications, *edited by K. L. Mittal and A. Pizzi*
15. Impurities in Engineering Materials: Impact, Reliability, and Control, *edited by Clyde L. Briant*
16. Ferroelectric Devices, *Kenji Uchino*
17. Mechanical Properties of Ceramics and Composites: Grain and Particle Effects, *Roy W. Rice*
18. Solid Lubrication Fundamentals and Applications, *Kazuhisa Miyoshi*
19. Modeling for Casting and Solidification Processing, *edited by Kuang-O (Oscar) Yu*
20. Ceramic Fabrication Technology, *Roy W. Rice*
21. Coatings of Polymers and Plastics, *edited by Rose A. Ryntz and Philip V. Yaneff*

*Additional Volumes in Preparation*

Micromechatronics, *Kenji Uchino and Jayne Giniewicz*

Ceramic Processing and Sintering: Second Edition, *Mohamed N. Rahaman*

To Thomas Yaneff,  
who passed away during the production of the manuscript  
and constantly encouraged and supported its writing and publication.

## Preface

As a group, plastics are seeing increased widespread usage on a global scale. They continue to proliferate and dominate many industrial applications at ever-increasing rates. The shift from metal to plastic offers many advantages such as light weight, ease of formability, and low cost. While new types and grades of plastics emerge, many new and exciting challenges are introduced for the coating formulator and, ultimately, the part decorator. Adhesion and painted-part performance require attention to the smallest detail, from dispersion techniques utilized in formulating the resins to molding protocol utilized to fabricate the component, to paint type and application methods utilized to decorate the component, to service-life durability and performance, and finally to reuse or recycle technologies utilized to alleviate land filling.

This book is directed toward both scientists and technologists working in the field of coatings for plastics. Chapter 1 begins with an extensive discussion on the types of plastics in use today and references the future needs and types of characteristics required to lower costs and enhance performance. Chapter 2 is then devoted to plastics processing requirements, which discusses molding parameters and the tooling needed to produce aesthetically pleasing and performance-capable parts.

Adhesion and the formulation tools required to achieve adhesion are discussed in Chapter 3, in the context of low surface free energy plastics, e.g., olefins. The ability to enhance adhesion as well as the possibility of increasing paint transfer efficiency, e.g., conductivity of the part, are discussed in subsequent chapters. Alternatives to paint are also addressed, in Chapter 8, particu-

larly with respect to the need to achieve lower-cost, more environmentally compliant technologies.

Once a plastic part is decorated, issues centered on dirt and paint defects are addressed from the analytical point of view, and suggestions are made in Chapter 6 on how to identify and alleviate these defects.

We address an ever-increasing priority in Chapter 7—that of plastic part recycling and reuse once parts have reached the end-of-life cycle. The ability to remove paint is discussed in terms of process and performance. The ability to compatibilize dissimilar materials in lieu of the complexity of plastic families utilized industrially is also addressed.

Future trends in European and North American plastics markets are addressed in Chapters 9 and 10 from a product-life-cycle perspective. Specialized needs of the market or customer as well as environmental legislation, end-of-life requirements, and projected technologies required to achieve the proposed targets are introduced.

This book was born out of the perceived need for a comprehensive work to address decorated plastic components as systems rather than as independent parts. The interplay of resin chemistry, processing technology, and decoration scheme is a complex mix of interrelated events. Treating each event separately often leads to insurmountable issues, from potential decohesion of the plastic to potentially aesthetically displeasing appearance, and even to potential adhesion problems in the field. We hope that by addressing the overall manufacturing processes required to produce decorated plastic components as a system, we can begin to explore the possibilities of expanding the role of plastic in the industry. By improving overall performance of these materials there is no end to the possibilities of applications in which plastics can be utilized.

*Rose A. Ryntz*  
*Philip V. Yaneff*



# Contents

|   |            |
|---|------------|
| <i>Preface</i>                                      | v          |
| <i>Contributors</i>                                 | ix         |
| <br>  |            |
| <b>1 Overview of the Automotive Plastics Market</b> | 1          |
| Susan J. Babinec and Martin C. Cornell              |            |
| <br>  |            |
| <b>2 Plastics Processing</b>                        | 47         |
| Steven D. Stretch                                   |            |
| <br>  |            |
| <b>3 Formulating Plastics for Paint Adhesion</b>    | 85         |
| Dominic A. Berta                                    |            |
| <br>  |            |
| <b>4 Polymers for Coatings for Plastics</b>         | 121        |
| J. David Nordstrom                                  |            |
| <br>  |            |
| <b>5 Performance and Durability Testing</b>         | 157        |
| Philip V. Yaneff                                    |            |
| <br>  |            |
| <b>6 Painting Problems</b>                          | 203        |
| Clifford K. Schoff                                  |            |
| <br>  |            |
| <b>7 Recycling of Automotive Plastics</b>           | 243        |
| Rose A. Ryntz                                       |            |
|   | <b>vii</b> |

|  |     |
|--|-----|
| <b>8 Alternatives to Coatings for Automotive Plastics</b><br>Norm Kakarala and Thomas Pickett                  | 279 |
| <b>9 Trends in Coatings for Automotive Plastics and Rubber in<br/>North America and Europe</b><br>Robert Eller | 293 |
| <b>10 Automotive Plastic Coatings in Europe</b><br>Hans Christian Gruner and Klaus-Werner Reinhart             | 317 |
| <i>Index</i>   | 353 |

## Contributors

**Susan J. Babinec** Corporate Materials Science, Dow Chemical Company, Midland, Michigan, U.S.A.

**Dominic A. Berta, Ph.D.** Research and Development, Basell Polyolefins, Elkton, Maryland, U.S.A.

**Martin C. Cornell, B.S.** Dow Automotive, Research and Development, Dow Chemical Company, Auburn Hills, Michigan, U.S.A.

**Robert Eller, B.S., M.S.** Robert Eller Associates, Inc., Akron, Ohio, U.S.A., and Bordeaux, France

**Hans Christian Gruner, Diplom-chemiker, Dr.** Coatings for Plastics, Dupont Performance Coatings, Cologne, Germany

**Norm Kakarala, Ph.D.** Advanced Development Group, Delphi Safety and Interior Systems, Troy, Michigan, U.S.A.

**J. David Nordstrom, Ph.D.** Polymers and Coatings Program, College of Technology, Eastern Michigan University, Ypsilanti, Michigan, U.S.A.

**Thomas Pickett, M.S., M.B.A.** Materials Engineering, General Motors Corp., Warren, Michigan, U.S.A.

**Klaus-Werner Reinhart, Diplom-Ingenieur** Surface Technology/Process Engineering and Application, DuPont Performance Coatings, Wuppertal, Germany

**Rose A. Ryntz, Ph.D., M.B.A.** Advanced Material Engineering, Visteon Corporation, Dearborn, Michigan, U.S.A.

**Clifford K. Schoff, Ph.D.** Schoff Associates, Allison Park, Pennsylvania, U.S.A.

**Steven D. Stretch, B.S.Chem, M.B.A.** Automotive Research and Development/Engineering, Emhart Fastening Technologies, Inc., Mt. Clemens, Michigan, U.S.A.

**Philip V. Yanoff, B.Sc., M.Sc., Ph.D.** DuPont Herberts Automotive Systems, DuPont Performance Coatings, Ajax, Ontario, Canada

# 1

## Overview of the Automotive Plastics Market

**Susan J. Babinec**

Dow Chemical Company, Midland, Michigan, U.S.A.

**Martin C. Cornell**

Dow Chemical Company, Auburn Hills, Michigan, U.S.A.

### 1 PLASTICS MARKETS

Human development is clearly linked to continuous improvements in the materials used every day. Entire stages of history have been named after the critical materials—Stone Age, Bronze Age, Iron Age, and now, the Age of Plastics. When asked his opinion on chemistry’s largest contribution to science and society, Lord Todd, the President of the Royal Society of London, responded: “I am inclined to think that the development of polymerization is, perhaps, the biggest thing chemistry has done, where it has had the biggest effect on everyday life. The world would be a totally different place without artificial fibers, plastics, elastomers, etc. (1).”

Indeed, polymeric materials are ubiquitous in nearly all societies, with over 126 million metric tons consumed during 2000 (2) in the combined durable and nondurable markets. The range of unique combinations of performance characteristics, in comparison to metals and ceramics, presents both a significant value in well-established markets, as well as a host of new opportunities in emerging markets with demands that cannot be met by traditional materials.

Figure 1 shows the relative global consumption of major polymers. Polyethylene (PE), polypropylene (PP), and polyvinyl chloride (PVC) represent over 80% of the global total volume, primarily because of their dominance in packaging and building and construction markets. However, engineering thermoset and thermoplastic polymers also offer outstanding performance in certain demanding

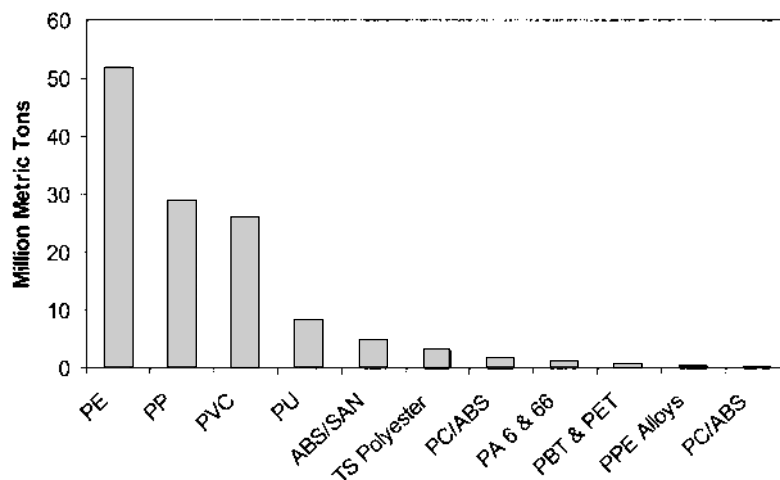

Fig. 1 Global consumption of major plastics in 2000. (From Ref. 2.)

durable goods applications, and thus also enjoy a significant global volume. The engineering plastics include polyurethanes (PU) and polyurea; acrylonitrile/butadiene/styrene (ABS) and styrene/acrylonitrile (SAN) copolymers; polycarbonates (PC); polyamides (PA); and polybutylene terephthalates (PBT) and polyethylene terephthalate (PET) polyesters. As replacement for metals, they offer the combination of inherent corrosion resistance and high strength. Examples of such applications include fencing, park benches, and automotive fuel tanks and exterior components.

Both durable and nondurable applications often require the plastics to be either printed or coated. As such, the interfacial characteristics of the plastic and the particular ink or coating are typically of concern during initial material selection and system design. While this book focuses on the coating of polymers, many of the principles discussed are also applicable to printing on plastic substrates.

Coatings are used because they efficiently impart a host of desirable features to substrates, such as enhanced aesthetics, greater barrier to moisture and chemicals, improved resistance to weathering and surface damage through physical impact, and certain specialty characteristics such as electrostatic dissipation. One example is polycarbonate optical discs, which are used as digital video discs (DVD) and compact discs (CD), and which are sputter coated on one side, typically with aluminum, aluminum alloys, or gold. These thin metal coatings are covered with an ultraviolet (UV)-cured, clear, acrylic coating that provides protection from the chemical and physical assaults of the environment. Another example is the PET bottle, which is coated with plasma-deposited  $\text{SiO}_2$  and other SiCO barrier coatings to prolong the shelf life of its contents.

Because the coating of plastics is often driven by the need for excellent appearance and enhanced performance under extended use, durable goods by definition are overwhelmingly the substrates that can bear the burden of this additional cost. Thus, the use of coated plastics is very important in the automotive market in which the performance demands are high, and their maintenance throughout the vehicle lifetime is paramount.

### 1.1 Automotive Plastics Markets

The automotive industry exploits the entire range of performance characteristics offered by many polymer and plastic families. Table 1 lists the major plastics currently used in this market. Elastomeric and cellular materials provide comfort in seating systems, cushion the ride by dampening vibrations from the powertrain and suspension, and absorb and dissipate impact energy. At the other end of the performance spectrum, structural plastics and composites are the light-weight alternatives to metal that provide load-bearing body structures and help the industry meet stringent requirements for lower emissions and higher fuel economy. Plastics also allow cost-reducing consolidation of parts and function compared to assembled, multipart metal components, and provide desirable fea-

**TABLE 1** Major Plastics Used in Automotive Applications

---

|  |
|--|
| Polyethylene (PE)                        |
| Polypropylene (PP)                       |
| Polyvinyl chloride (PVC)                 |
| Polyurethane (PU)                        |
| Polyurea                                 |
| Acrylonitrile/butadiene/styrene (ABS)    |
| Styrene/acrylonitrile (SAN)              |
| TS polyester                             |
| Polycarbonate (PC)                       |
| Polyamide (PA)                           |
| Polybutylene terephthalate (PBT)         |
| Polyethylene terephthalate (PET)         |
| PPE alloys                               |
| Unsaturated polyester resins (UPER)      |
| Polyphenylene oxide (PPO)                |
| Acrylic                                  |
| ASA                                      |
| AES                                      |
| Polyphenylene oxide/polystyrene (PPO/PS) |
| Polyphenylene oxide/polyamide (PPO/PA)   |

---

tures such as complex styles and noise reduction while employing relatively simple manufacturing processes.

Selection of the appropriate polymer for an automotive application is based on functional considerations such as cost, density, chemical resistance, weatherability, recyclability, ease of processing, as well as the significant physical requirements of impact, strength, and stiffness—all of these over the anticipated range of use temperatures. For exterior applications, these temperatures can cover a large range, typically from sub-zero to the maximum temperature of an object heated for long periods of time in the blazing sun of a desert (as high as 100°C).

The global automotive market consumed 5.6 million metric tons of major plastics during 2000, with thermoplastic olefin (TPO) elastomers as the dominant material (Fig. 2). Although this automotive volume is only about 4.4% of its global total across all applications (2), it represents 115.6 kg (254.3 lb) of plastics per each light-duty vehicle manufactured in North America, according to data generated by Market Search Inc., in their *Automotive Plastics Report—2000* (Fig. 3), and illustrates the intense drive of this industry to combine low cost with performance (3). Figure 2 also highlights the emphasis on engineering plastics in the automotive industry compared to the global market, in which polyolefins decidedly dominate.

Figure 3 shows that PP and PP blends (TPO) are the highest volume materials in the important light-duty vehicle (cars, vans, pickup trucks, and sport-utility vehicles) market in North America. This ranking reflects the signifi-

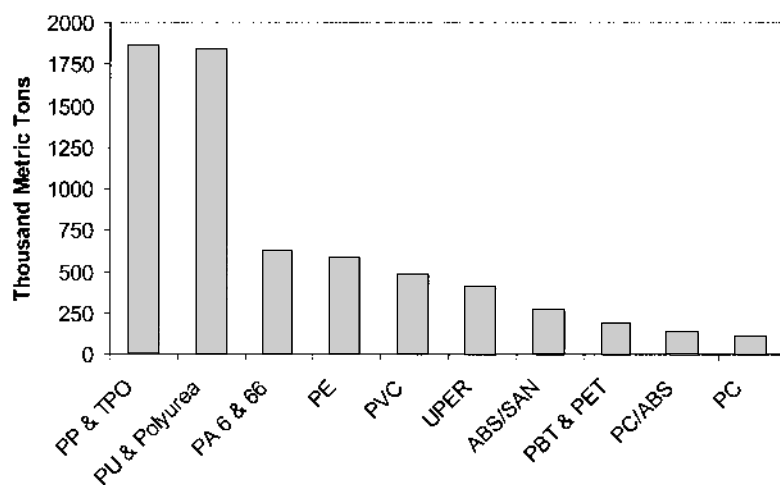

Fig. 2 Global consumption of major automotive plastics in 2000. (From Ref. 2.)



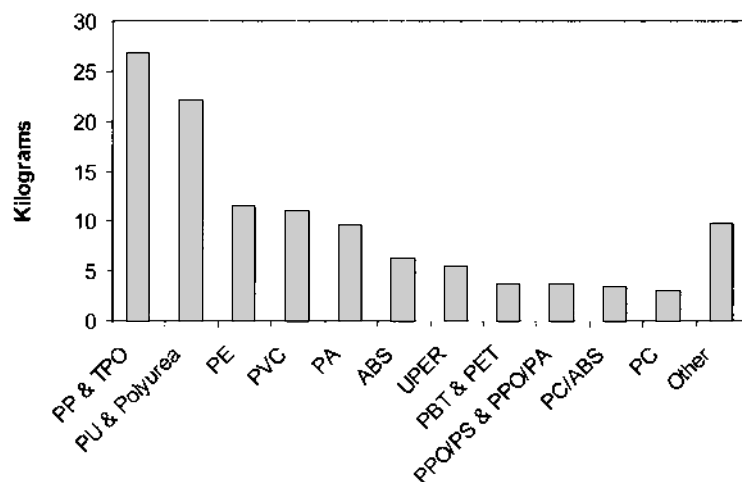

FIG. 3 Consumption of major automotive plastics per light-duty vehicle manufactured in North America in 2000. (From Ref. 2.)

cant use of PP for *interior* components and of TPO blends for *exterior* flexible front- and rear-end fascia. The rubber modification of PP, to yield TPO, for *exterior* applications is critically important for maintenance of the requisite ductility across the exterior temperature range of use, which is broader than that for interiors. Polyurethane thermosets are nearly as significant as the polyolefins in the automotive market because of their widespread use in seat cushioning and upholstery. The major use of the third-ranked PE (as high-density polyethylene [HDPE]) is primarily as blow-molded fuel tanks. In this application the HDPE is becoming an increasingly important alternative to steel, due to the superior corrosion resistance, lower weight, and the ability to provide complex shapes that facilitate greater exterior design freedom. The growing market for PA 6 and 66 homopolymers reflects a change in the under-the-hood component market where high temperature performance combined with design flexibility is at a premium.

Figure 4 shows the relative consumption of the most significant polymers and plastic composites used *only in the exterior* portion of this same light-duty vehicles segment made in North America in 2000 (3). The majority of plastics are coated in this exterior applications market segment.

Predictions on the continued use of plastics in light-duty vehicles are based on three major driving forces: cost, environmental compatibility, and compliance with safety regulations. These driving forces favor components and systems that offer lower overall total cost, add benefits perceived by the vehicle

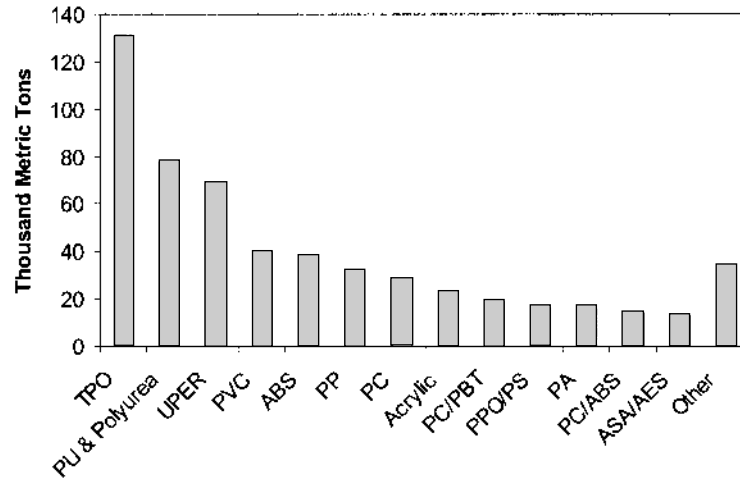

Fig. 4 Consumption of major automotive plastics in vehicle exteriors manufactured in North America in 2000. (From Ref. 3.)

owner, and/or reduce weight without compromising safety. Plastics and polymer composites clearly satisfy these requirements, and their use in North American light-duty vehicles is predicted to grow from 115.6 kg (254.3 lb) per vehicle in 2000 to 138.5 kg (277 lb) per vehicle by 2010 (3). Figure 5 illustrates this trend for all light-duty vehicle applications, and is segmented by polymer family. Noteworthy is the predicted greater than average increase in the use of PP and TPO. This trends reflects the favor given to polymeric materials that can fulfill the need for low cost and low density (lightweight) without sacrificing overall performance. Expected increases in plastic composites for body panels and structural members is primarily a result of the increased use of unsaturated polyester resins in expanded markets held today by metals.

## 1.2 Automotive Coatings Selection

In the automotive market, appearance is often a significant functional and aesthetic requirement influencing polymer selection. For example, with large exterior body parts, such as fascia and body panels, a surface finish that matches the adjacent sheet metal is an absolute requirement dictated by consumer expectations. This consumer preference for Class A exterior surface quality has several times thwarted attempts to eliminate current painting processes, which tend to be costly and environmentally unfriendly. Pigmented, molded-in-color (MIC) fascia and claddings have only been successful, at this time, on lower line and

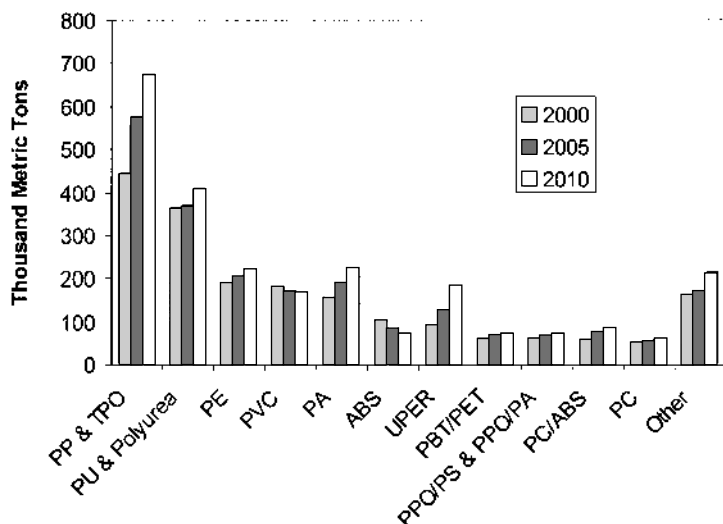

FIG. 5 Forecasted consumption of plastics in vehicles manufactured in North America. (From Ref. 3.)

niche sport-utility vehicles. When attempted in other upscale markets, vehicles without painted trim have been left unsold for long periods of time—standing on the lots in droves.

In addition to superior aesthetics, exterior coatings are also expected to provide resistance to minor impacts and scratch-and-mar insults, as well as resistance to degradation from visible and UV radiation, acid rain, ozone, and other environmental chemicals. For example, lightweight polycarbonate covers for headlamp assemblies are coated with tough and durable organosilanes that protect them from UV radiation; fuel, engine, and cleaning chemicals; and impact from road debris and insects. Variations on these coating chemistries are under development for PC window assemblies. The success of these efforts would enable commercialization of this important application, and allow the industry to lower vehicle weight and improve security against forced entry.

Bright, metallized plastics add style and differentiation to vehicle models. Common uses of such metallized plastics include radiator grills, wheel covers, appliques, and accent trim around windows and on deck lids and fascia. Electroplating techniques are quite specialized and, as in the case of chrome plating, often rely more on mechanical attachment of the coating to the substrate rather than covalent chemical-bonding mechanisms featured by most organic-based coatings (4,5). The large difference in surface tension and chemical speciation for metal versus plastic surfaces results in this poor native interaction.

A few functional, exterior automotive plastic components, such as cowl-vent grills and windshield-wiper assemblies, are universally accepted as unpainted molded-in-color components. These are not typically overcoated.

### 1.2.1 Examples of Specific Plastics Use

The dominant materials in flexible fascia are thermoplastic olefins, TPO (polypropylene modified with, typically, ethylene-propylene-diamine monomer [EPDM]), followed by polyurea (Fig. 6). Because of consumer preference for high surface quality, most fascia are fully or partially painted with body-matching coatings. Unpainted fascia having molded-in-color are prepared from both TPO and ionomers of polyethylene.

The predominant use of thermoset unsaturated polyester resins (UPER) is as components of sheet-molding compound (SMC) body panels—fenders, doors, hoods, roofs, lift gates, and pickup rear-quarter panels (Fig. 7). These panels are typically attached to the vehicle body and painted on the assembly line, right beside adjoining steel and aluminum components. The high-temperatures of the coating bake ovens places a premium on high-temperature durability, and as such these thermosets are typically the material of choice. Another major use of UPER (approximately 16,300 metric tons in North America during 2000) is as bulk molding compound (BMC) to mold headlamp reflectors. BMC is preferred in this application because of its dimensional stability at the high temperatures associated with halogen and HID light sources.

Plated ABS is extensively used on radiator grills and headlamp bezels. Also, ABS is a frequent material of choice for exterior trim components. Because of their enhanced toughness and thermal stability over ABS, PC/ABS blends are often used on chrome-plated wheel covers (Fig. 8). PC/ABS is also used in door and deck-lid body panels on Saturn vehicles (Fig. 9).

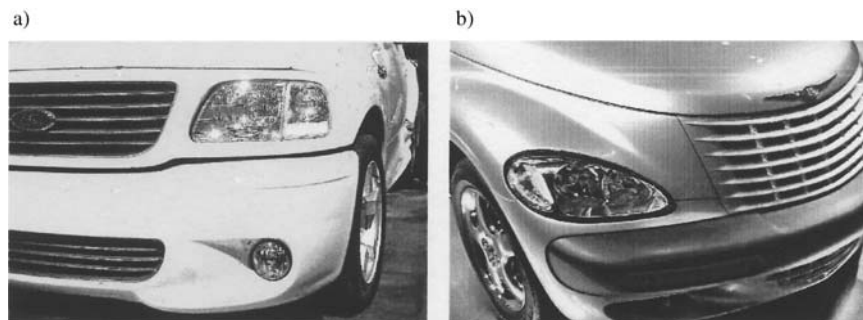

**FIG. 6** Examples of TPO used for flexible fascia: a) painted TPO fascia, b) molded-in-color TPO bumper/fascia on the Chrysler PT Cruiser.

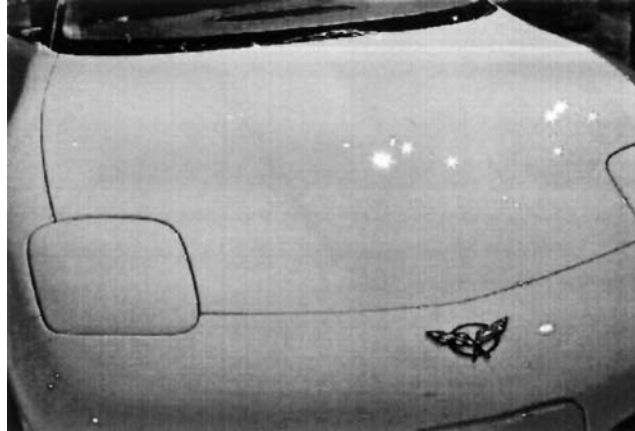

FIG. 7 Example of UPER used in SMC hood: SMC hood on Chevrolet Corvette.

Side trim moldings and claddings predominantly use PVC, TPO, or polyurea. Consumer preference trends are for body-color matched trim and claddings on higher line vehicles, but pigmented, unpainted TPO claddings are common on many sport-utility vehicles (Fig. 10).

Polyurea fenders are used on sports vehicles, such as the Chevrolet Corvette, Chevrolet Camaro, and Pontiac Firebird, and on fender extensions for dual-wheel pickup trucks (Fig. 11). Polyurea resins having dimensional stability in e-coat baking ovens are increasingly being used for large rear-quarter panels of pickup trucks because of their lightweight, resistance to damage, high surface quality, and often lower cost than SMC or multipart assembled metal alternatives.



FIG. 8 Example of PC/ABS used in wheel covers: Pontiac Grand AM GT.



FIG. 9 Example of PC/ABS used in body panels: Saturn PC/ABS door panels.

The major vehicle exterior applications for polycarbonate and acrylic polymers are lens covers for light modules (Fig. 12). Damage resistance and optical clarity are the required performance characteristics. Plastic headlight and front signal-light lens covers are made of polycarbonate, often coated with protective transparent organosilane coatings. Rear lighting modules tend to use uncoated acrylics for lens covers.

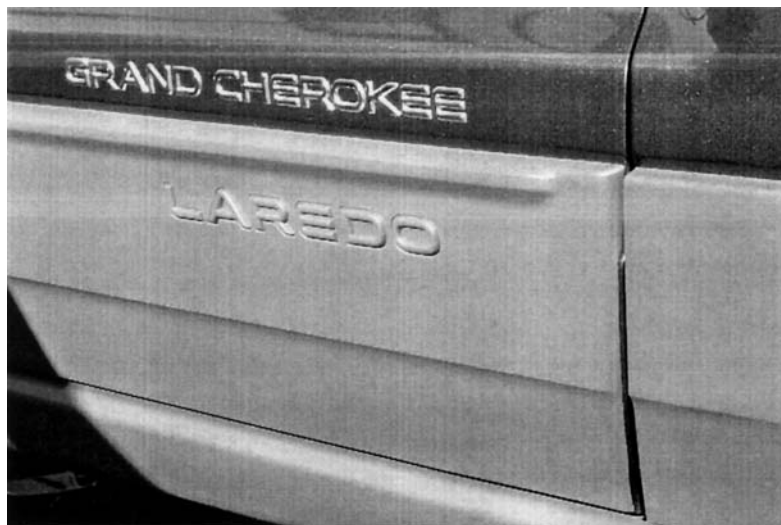

FIG. 10 Unpainted TPO cladding on the 2001 Chrysler Grand Cherokee.

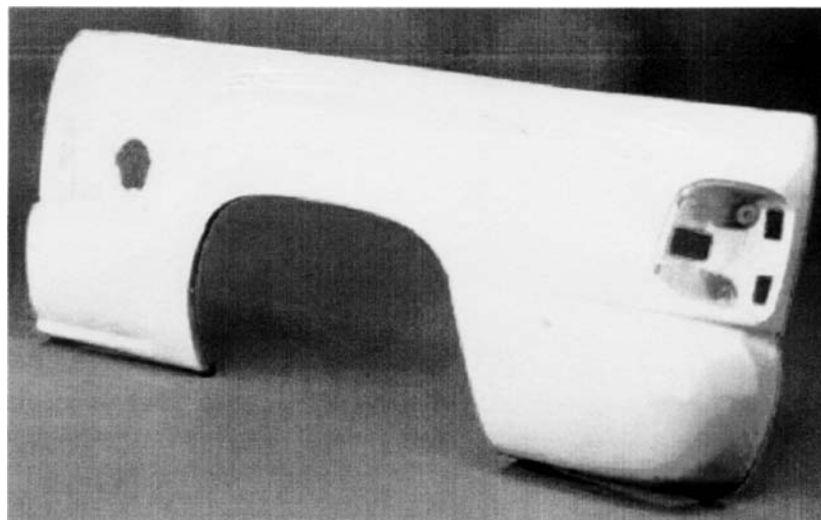

FIG. 11 Example of polyurea used in fenders: GMT 800 rear-quarter panel of Dow SPECTRIM HH390 polyurea RRIM.



FIG. 12 Example of polycarbonate used in lens cover: 2001 Ford Mondeo headlight assembly with a PC lens cover and metallized reflector.



Fig. 13 Unpainted ASA/AES mirror housing.

Programs are underway to develop lightweight and intrusion-resistant PC window glazing for vehicles. Plastic glazing is likely to be coated with clear protective coatings.

The major exterior automotive use for PP, unblended with elastomer, is in noncosmetic energy-management foams for bumper systems. Such parts are rarely coated or painted.

Painted alloys of PPO and PS and pigmented, unpainted blends of ASA/AES are often used on exterior applications such as cowl-vent grills and mirror housings (Fig. 13).

Included in the “other” category of polymers used on vehicle exteriors are alloys of PPO and PA, which are increasingly used for lightweight body panels to improve fuel economy (Fig. 14). The high-temperature stability of these blends enables them to be mounted on the vehicle body prior to painting, thus accommodating existing assembly line logistics. Many of these PPO/PA blends



Fig. 14 2001 Volkswagen Beetle fender of PPO/PA.



also contain conductive carbon fillers so that the conductive primer coating can be eliminated. This conductive filler ensures that the transfer efficiency of electrostatically applied basecoat and clearcoat paints on the modified polymer is equal to that of surrounding metal parts. This is discussed in greater detail in the section on electrostatic painting in this chapter.

Polyamides are the dominant polymers used for mirror housings, with 3,400 metric tons consumed in vehicle exteriors manufactured in North America in 2000. Polyphenylene oxide/polyamide filled with carbon fibers was recently introduced to provide charge dissipation during the electrostatic painting process of mirror housings. As with PPO/PA body panels, this semiconductive polymer blend ensures high paint-transfer efficiency while eliminating the need to apply a separate conductive primer (Fig. 15).

In contrast to exterior surfaces, the interior plastic surfaces of most vehicles are pigmented rather than coated. The primary reason is that consumers prefer low-gloss, nonglare surfaces that blend harmoniously with interior fabrics and leather. Some plastics used on interior vehicle surfaces are coated to impart special characteristics, such as a soft touch and feel on control knobs; antiglare and mar resistance on instrument panel top surfaces; and soil and stain resistance for cushioned steering wheel covers. Another reason why interior plastic surfaces are rarely coated is because the potential of exposure to visible or UV radiation, environmental pollutants, chemicals, and mechanical insults is significantly less than for exterior surfaces.

Coatings are seldom used on noncosmetic parts, especially so with power-train and suspension systems. However, coatings are being increasingly considered to enhance performance characteristics, such as fuel and chemical resistance, and as an efficient electromagnetic interference (EMI) shield for electrical and electronic housings.



**FIG. 15** Example of PPO/PA used in mirror housing: 2000 Mercedes CL500 mirror housing.

## 2 CHEMICAL AND PHYSICAL PROPERTIES OF POLYMERS

The behavior of a polymer is based on both its chemical composition and its physical state. The chemical characteristics of homopolymer and copolymers are fundamentally derived from the choice of monomers. Table 2 lists common engineering polymers.

In addition to the chemical composition, there are several distinct physical arrangements of polymer chains, which contribute to performance, as illustrated in Figure 16. In the melt state, the arrangement uniquely affects the rheological behavior as a function of shear and temperature. In the solid state, the arrangement affects the viscoelastic properties, and the mechanical properties such as strength and ductility. In the transition from liquid to solid, the crystallization kinetics are also a strong function of the precise arrangement.

For copolymers, the full chemical description also includes the sequencing of monomers, with common patterns listed in Table 3. Block copolymers are interesting materials in many applications because the high level of control of their sequencing results in the formation of precise morphologies on a very small scale (less than 100 nm). Figure 17 shows the morphology map for certain well-controlled diblock copolymer microstructures. Although the precise details of the diblock phase diagram depend on the composition, and on both the absolute and relative lengths of the A and B blocks, all diblocks will form these same phases.

Selecting an appropriate material frequently begins with strength requirements. Figure 18 shows the stress/strain response patterns that characterize different types of polymers. Every material follows one of these basic behaviors, but with quantitatively unique values. The slope of a stress/strain curve is the modulus. High-modulus materials typically require a large force for a small deformation, but brittle fracture at low elongation. Low-modulus materials, elastomers, require comparatively little force for a large deformation and offer great extension before ductile yielding. Crystalline, glassy, and semicrystalline polymers have higher modulus than rubbers, but either fail or yield at substantially lower elongation. Further, the modulus of polymer crystallites is a function of orientation to the stress field, with higher values typically observed in the parallel direction. Table 4 lists ranges of modulus for different classes of materials.

Modulus is a function of temperature, with certain temperatures representing important transitions in the material. Figure 19 shows that modulus versus temperature plots typically have a somewhat predictable response when normalized to the thermal distance from the glass transition temperature ( $T_g$ ). As the glass-transition temperature is approached and exceeded, there is a large drop in modulus. In coated plastics it is important that the  $T_g$  of the substrate be greater than the cure temperature of the coating so that the physical shape of the part is not compromised by creep during this final processing step. Because

TABLE 2 Chemical Composition of Common Polymers

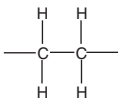
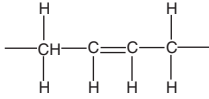
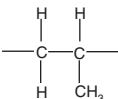
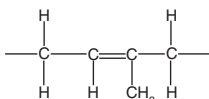
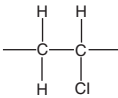
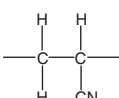
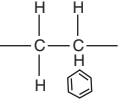
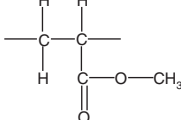
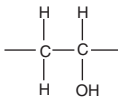
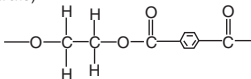
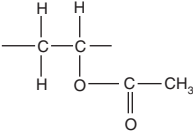
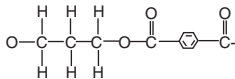
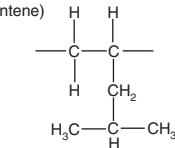
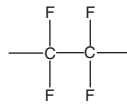
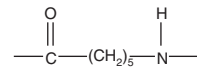
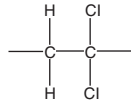
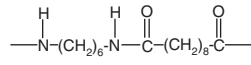
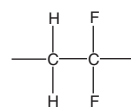
| Polymer name            | Repeat unit   | Polymer name                 | Repeat unit   |
|-------------------------|---|------------------------------|---|
| Polyethylene            |    | Poly(1, 4-butadiene)         |    |
| Polypropylene           |    | Polyisoprene                 |    |
| Polyvinylchloride       |    | Polyacrylonitrile            |    |
| Polystyrene             |    | Polymethylmethacrylate       |    |
| Polyvinylalcohol        |  | Poly(ethylene terephthalate) |   |
| Polyvinylacetate        |  | Poly(butylene terephthalate) |   |
| Pol(4-methyl-1-pentene) |  | Polytetrafluoroethylene      |  |
| Polyamide 6             |  | Poly(vinylidene dichloride)  |  |
| Polyamide 6, 10         |  | Poly(vinylidene difluoride)  |  |

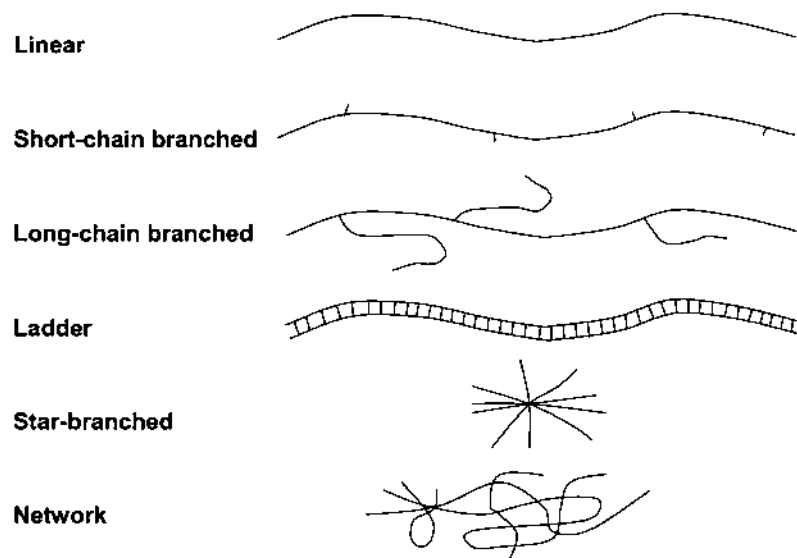

FIG. 16 Physical arrangement of polymer chains.

most durable coatings require curing at elevated temperature, the  $T_g$  of a material is thus an important design constraint.

Table 5 illustrates the relationship between chemical composition and both the  $T_g$  and the melt-transition temperature ( $T_m$ ). Polar materials have a high cohesive energy and so have elevated thermal transitions. Nonpolar polyolefins have the smallest intermolecular interactions and thus the lowest temperature transitions.

Materials across many families can be compared not only on their strength, but also on the strength at a relative cost per unit volume (Fig. 20).

TABLE 3 Sequencing of Copolymers

| Type of copolymer     | Sequencing         |
|-----------------------|--------------------|
| Random copolymer      | AABBBABBAAB        |
| Alternating copolymer | ABABABABAB         |
| Diblock copolymer     | AAAABBBBBB         |
| Triblock copolymer    | AAAABBBBBAAAA      |
| Pentablock copolymer  | AAABBBBAAABBBAAAA  |
| Terpolymer            | AABBCCCBBAABBCCCAA |

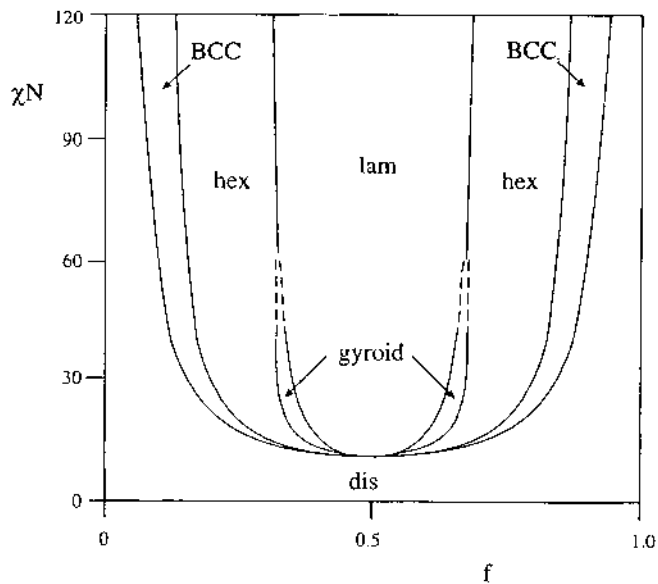
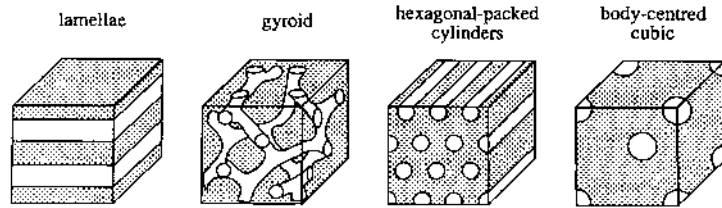

FIG. 17 Schematic phase diagram for a diblock copolymer.  $F$  = volume fraction of one of the blocks,  $\chi$  = Flory-Huggins interaction parameter, and  $N$  = degree of polymerization. (From Ref. 65.)

The design guidelines in this plot help clarify the selection criteria. Polymers offer an excellent balance of strength and cost and readily fit into applications requiring moderate strength at low cost. The alternatives for many durable applications, such as ceramics and metals, have more than the necessary strength, but are costly to use due to processing or corrosion resistance needs.

In addition to chemical composition and physical state, processing details can significantly affect performance. For example, process shear rate and cooling kinetics can change the shape and size distribution of crystallites in a polycrystal-

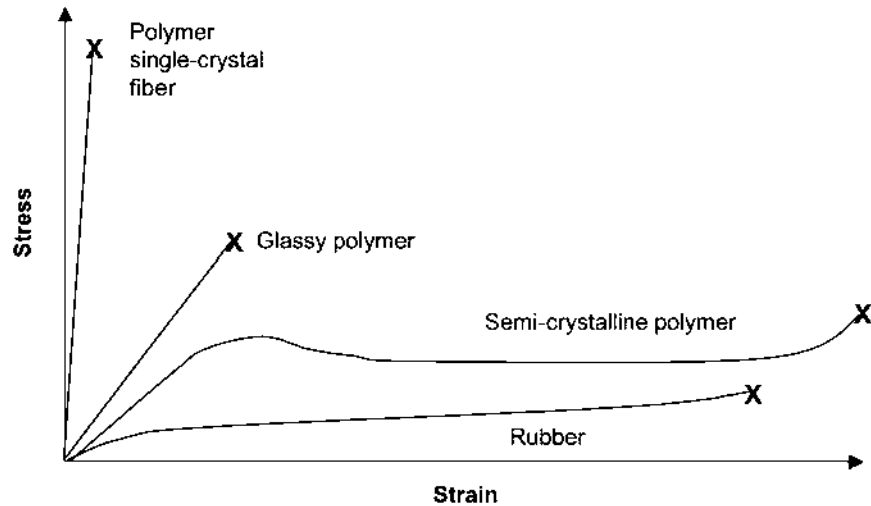

FIG. 18 Stress/strain curves of different polymers. (From Ref. 66.)

line material. In a formed part, these will be a function of distance from both the injection port and the mold wall, and may dictate the final process conditions.

## 2.1 Surface vs. Bulk Properties

Differences between surface and bulk properties of the polymer can affect performance in certain coating situations and should be anticipated. In comparison to interfaces of small molecules, a macromolecular interface ties surface boundary conditions further into the depth of the interior. Because the dimensional length scale is larger for polymers, physical and chemical property gradients are less abrupt than with small molecules. The depth into which the polymer interface extends is determined by the number of polymer units, and thus it increases with increasing molecular weight. For example, Figure 21 shows the  $T_g$  gradient

TABLE 4 Typical Values of Young's Modulus for Different Types of Polymers

| Type of polymer                    | Young's modulus ( $\text{N/m}^2$ ) |
|------------------------------------|------------------------------------|
| Elastomer                          | $\sim 10^6$                        |
| Glassy polymer                     | $\sim 10^9$                        |
| Polymer crystal perpendicular to c | $\sim 10^9$                        |
| Polymer crystal parallel to c      | $\sim 10^{11}$                     |

Source: Ref. 66.

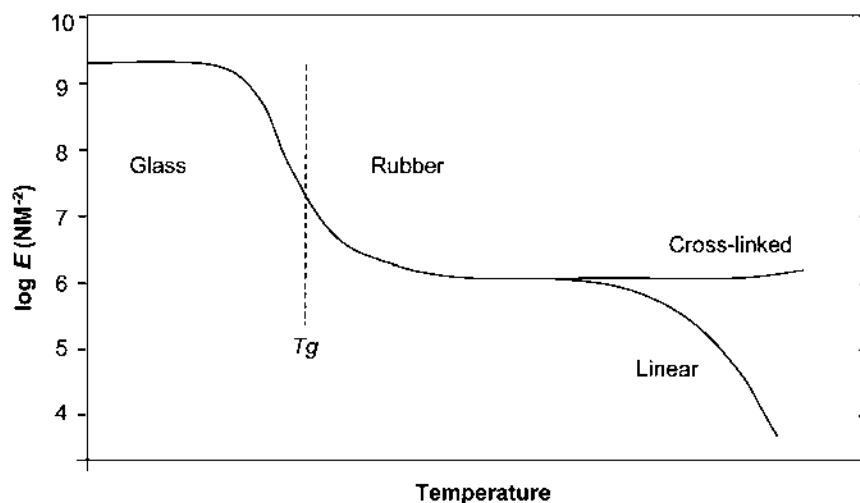

FIG. 19 The effect of temperature on the modulus of a polymer. (From Ref. 66.)

TABLE 5 Approximate Values of  $T_g$  and  $T_m$  of Various Polymers

| Repeat unit   | Side group (X)  | $T_g$ (C) | $T_m$ (C) |
|---|---|-----------|-----------|
| -CH <sub>2</sub> -CH <sub>2</sub> -   |   | 140-270   | 410-419   |
| -CH <sub>2</sub> -CH <sub>2</sub> -O-                                       |   | 206       | 340       |
| -C <sub>6</sub> H <sub>6</sub> -O-  |   | 357       | 395       |
| -CH <sub>2</sub> -C <sub>6</sub> H <sub>6</sub> -CH <sub>2</sub> -          |   | 353       | 670       |
| -CH <sub>2</sub> -CH <sub>2</sub> -CO-NH-                                   |   |           | 603       |
| -CH <sub>2</sub> -CH <sub>2</sub> -CH <sub>2</sub> -CO-NH-                  |   |           | 533       |
| -CH <sub>2</sub> -CH <sub>2</sub> -CH <sub>2</sub> -CH <sub>2</sub> -CO-NH- |   |           | 531       |
| -CH <sub>2</sub> -CHX-  | -CH <sub>3</sub> -                                    | 250       | 460       |
|   | -CH <sub>2</sub> -CH <sub>3</sub> -                   | 249       | 398       |
|   | -CH <sub>2</sub> -CH <sub>2</sub> -CH <sub>3</sub> -  | 233       | 351       |
|   | -CH <sub>2</sub> -CH(CH <sub>3</sub> ) <sub>2</sub> - | 323       | 508       |
|   | -C <sub>6</sub> H <sub>6</sub> -                      | 373       | 513       |
|   | -Cl-  | 354       | -         |
|   | -OH-  | 358       | -         |
|   | -CN-  | 370       | -         |

Source: Ref. 66.

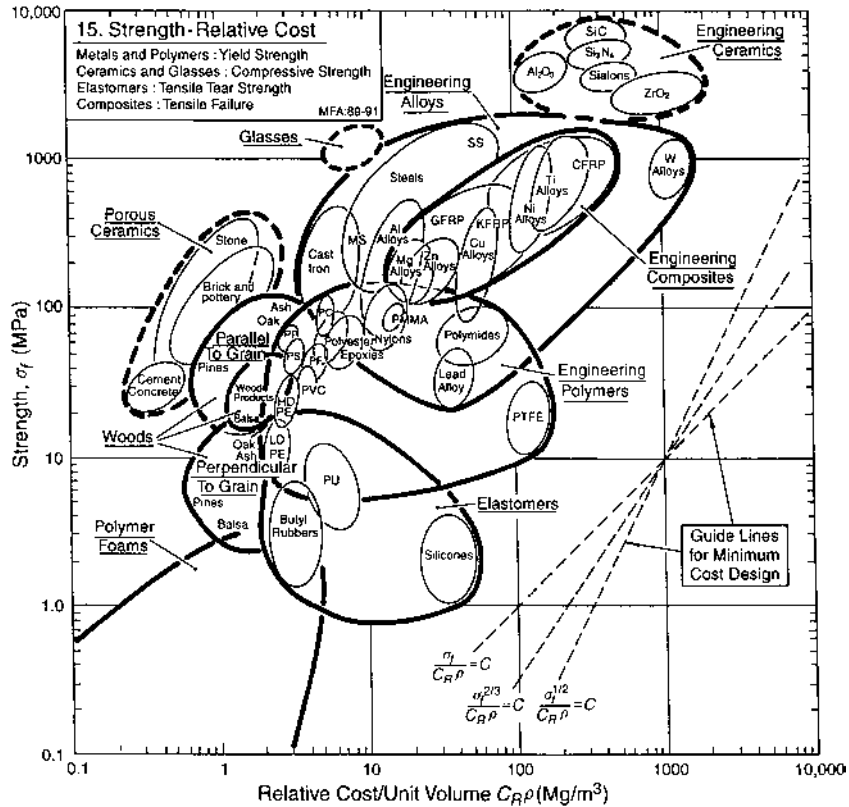

FIG. 20 A comparison of the strength of various materials and their cost per unit volume. (From Ref. 67.)

in a polystyrene film as a function of thickness and polymer molecular weight. The  $T_g$  reaches a stable value after about 100 nm.

Figure 22 offers another example of the interfacial gradient, specifically showing that the volume fraction of chemically end-grafted polystyrene chains varies as a function of distance from a surface for its blends with different matrix polymers. Polybutadiene (PBD) and poly(methylmethacrylate) (PMMA) are immiscible with polystyrene (PS) in the bulk; PS is chemically identical with the grafted chains, while poly(vinyl methylether) (PVME) and a blend of poly(phenylene oxide) and PS (PPO/PS) are miscible with polystyrene in the bulk. The chemically grafted material concentrates at the surface and does not extend any further than 350 Å into the bulk.

Although thermodynamics dictates the ideal, the interfacial structure can



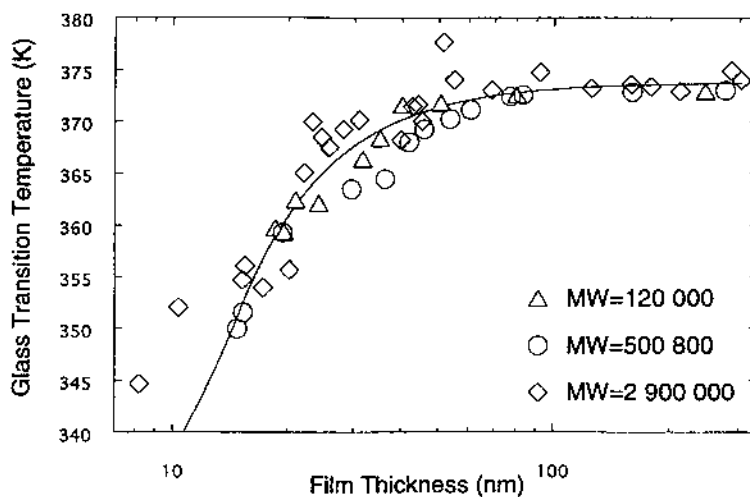

FIG. 21 The effect of film thickness and molecular weight on  $T_g$  of a thin polystyrene film on silicon. (From Ref. 68.)

also be a strong function of the processing history. For example, polymers near the surface are often more ordered than in the bulk due to differences in shear fields as a function of distance from the mold wall. This enriched surface crystallinity results in higher surface energies and potentially brittle and weakened boundary layers (6). The macromolecular surface should not be expected to reach equilibrium during its creation in the melt under ordinary processing conditions. Further, the kinetics of rearrangement to the ultimate state drastically reduce with temperature as a part is cooled.

The full description of the gradient in surface-to-bulk properties would include a density profile, the macromolecular configurations (center of mass of the molecules), and the positions of chain ends—both parallel and perpendicular to the surface. These details of the state of the polymer at the surface can affect both the mechanical aspects of its performance, such as scratch and mar resistance, and the diffusion coefficient of coatings and of solvent into the surface. Additionally, chemical characteristics such as surface speciation (chain-end concentration) can affect specific interactions with a coating. Over the last 10 to 15 years new surface analytical techniques have been developed that significantly increase our understanding of these characteristics of polymer surfaces and interphases. Some of these analytical techniques are listed in Table 6.

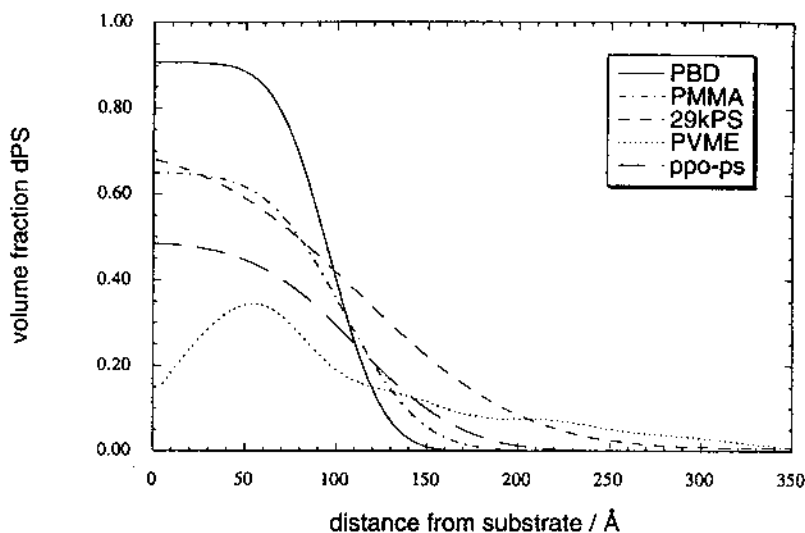

FIG. 22 Distribution of chemically end-grafted polystyrene chains as a function of depth. (From Ref. 68.)

### 3 ADHESION

The Webster definition of adhesion is simply: “the molecular attraction exerted between the surfaces of bodies in contact (7).” In the more technical world, it is understood that there are many complex components to adhesion in a system, both chemical and physical. Further, the wide variety of complex combinations limits the merit of general predictive rules of thumb. Instead, perhaps, it is useful to simply let a specific situation define an appropriate adhesion test, and thus the practically adherent system. A sufficiently adherent interface is one in which the appropriate applied load or stress did not exceed the total interfacial adhesive forces. Stresses in coated systems can be either compressive or tensile when experienced normal to the surface, shearing when in a parallel orientation, or some combination of these. Much can be learned from automotive adhesion requirements, because so many durable coating applications in so many situations are found in this industry. Table 7 summarizes some of the tests used to measure adhesion. The following sections offer summaries of important aspects of adhesion in practical coating systems.

### 3.1 Interfacial Binding Energies

The substrate/coating interfacial energy can be described from several perspectives: chemical, mechanical, and rheological. From the chemical (or thermodynamic) perspective, interfacial forces originate in the many fundamental attractive interactions between molecules. The total attractive forces holding the system together are calculated by multiplying the average interfacial bonding energy by the number of bonds per unit area. In addition to these interactive forces holding the system together at equilibrium, a material can use mechanical forces to practically dissipate energy in a dynamic situation—if the substrate/coating bond is strong enough to transmit the force. In this mechanical/rheological perspective, a host of yielding mechanisms can be brought to bear during a dynamic test. The magnitude of these dissipations depend on the viscoelastic properties of both the coating and the substrate. Accurate prediction of these mechanical responses can be difficult because the surface of a solid is known to frequently display different physical properties than those listed for bulk, as previously described (8).

Intermolecular energies vary with distance as shown in Figure 23, with the minimum in the potential energy curve taken as the equilibrium distance between two molecules or atoms. These forces can be classified in three major categories: (1) electrostatic forces between permanent dipoles and charges; (2) polarization forces of both atomic and molecular dipoles, which are induced by transitory fluctuations of charges and permanent dipoles; and (3) highly directional static covalent and chemical forces arising from full-charge transfer. Covalent bonds typically have the highest binding energy and thus are most desirable in any coating system. Some general aspects of these interactions are listed in Table 8.

### 3.2 Wetting

Because maximum attractive forces occur at short range, good wetting is often considered to be a prerequisite to high adhesive strength. When a liquid coating is placed on a substrate, it will spread in a manner that balances all forces in order to reach the most energetically favored state. An excellent figure of merit for wetting is the contact angle, which is the angle between the substrate and a tangent drawn to the liquid drop, as shown in Figure 24. The contact angle,  $\theta$ , is indicative of the strength of the substrate/liquid interaction—the higher the interaction, the smaller the contact angle.

Young's equation, Eq. (1), predicts the interfacial tension between two materials,  $\gamma_{sc}$ , from experimental contact angle measurements, where  $\gamma_s$  is the surface energy of the substrate and  $\gamma_c$  is the surface energy of the coating, both in air. For spontaneous wetting to occur, the contact angle must be zero, which

TABLE 6 Techniques Available for Polymer Surface Analysis

| Technique                        | Acronym      | Sampling depth | Depth resolution | Lateral resolution | Information content                       | Comments   |
|----------------------------------|--------------|----------------|------------------|--------------------|---|--|
| Scanning electron microscopy     | SEM          | 10 nm          | 10 nm            | 5 nm               | Direct image of surface topography        | Auger and x-ray mode can give chemical composition |
| Transmission electron microscopy | TEM          | $\infty$       | —                | 3 nm               | Two-dimensional profile                   | Special sample preparation required                |
| Scanning tunneling microscopy    | STM          | —              | 0.1 nm           | 0 nm               | Molecular imaging and surface topography  | Conductive substrate required                      |
| Atomic-force microscopy          | AFM          | —              | 0.1 nm           | 0.5 nm             | Molecular imaging and surface topography  | —  |
| X-ray reflectometry              | XR           | $\infty$       | 1 nm             | —                  | Composition profiles and roughness        | Interpretation requires model predictions          |
| Neutron reflectometry            | NR           | $\infty$       | 1 nm             | —                  | Composition profiles                      | Interpretation requires model predictions          |
| Ellipsometry                     | ELLI<br>VASE | $\infty$       | 1 nm             | —                  | Film thickness, refractive index profile  | Limited contrast                                   |
| X-ray photoemission spectroscopy | XPS<br>ESCA  | 10 nm          | 0.1 nm           | 10 $\mu$ m         | Surface composition, composition profiles | Radiation damage and sample charging are problems  |

|  | HREELS | 1 nm | 1 nm  | 1 μm | Surface composition, vibrational spectra                               | Radiation damage and charging are problems |
|--|--------|------|-------|------|--|--|
| High-resolution electron-energy loss spectroscopy  |        |      |       |      |  |  |
| Static secondary-ion mass spectroscopy             | SSIMS  | 1 nm | —     | 1 μm | Surface composition  | Complex spectra                            |
| Dynamic secondary-ion mass spectroscopy            | DSIMS  | ∞    | 13 nm | —    | Composition profile  | Etch rate is composition dependant         |
| Forward recoil spectroscopy                        | FRES   | μm   | 80 nm | —    | Composition profile  | —  |
| Rutherford back-scattering spectroscopy            | RBS    | μm   | 30 nm | —    | Composition profile of marker  | Requires heavy elements                    |
| Nuclear-reaction analysis                          | NRA    | μm   | 13 nm | —    | Hydrogen and deuterium composition profile                             | Resolution is depth dependant              |
| Infrared attenuated total-reflection spectroscopy  | IR-ATR | μm   | —     | —    | Vibrational spectra of polymer surface adjacent to ATR-crystal surface | —  |
| Infrared grazing-incidence-reflection spectroscopy | IR-GIR | mm   | —     | —    | Vibrational spectra of thin films and absorbed layers                  | —  |

Source: Ref. 57.

**TABLE 7** Summary of Common Industrial Adhesion Tests for Coatings

| Type of test                                    | Description   | Citation    |
|---|---|-------------|
| Tape test                                       | A series of cross-hatched cuts are applied to the coating, a pressure-sensitive tape is applied and pulled off. Adhesion is measured by the percent of material that is not pulled off by the tape.<br>Human elements are present in this test because of variations in tape application pressure and the rate and angle of pull. | ASTM D 3359 |
| Direct tensile adhesion test                    | An aluminum stud is mounted on the surface of the coating using a cyanoacrylate adhesive and then pulled to determine debonding force.  | ASTM D 5179 |
| Portable adhesion-test constrained blister test | Tensile stress is applied perpendicular to the coated substrate. This contrasts with the tape test, which involves some component of shear stress. Examination of the failed specimen reveals whether failure was adhesive or cohesive.   | ASTM D 4541 |
| Gravelometer                                    | A cascade of small sand particles is dropped onto the surface mounted on an inclined plane.   | SAE J 400   |

Source: Ref. 58.

means that the interfacial energy is greater than the difference between the two surface free energies.

$$\gamma_s = \gamma_c \cos\theta + \gamma_{sc} \quad \text{Eq. (1)}$$

Surface tension,  $\gamma$ , is a key parameter in describing a surface. It is defined as the reversible work associated with the creation of truncated bonds and molecular conformations that occur at the surface (outside of the bulk). For any given material, the literature typically offers a range of values for  $\gamma$ , which is a testament to the experimental and theoretical complexities of its determination. Table 9 lists one compilation of the surface energies of common polymers, both the composite value and the breakdown by polar/nonpolar interactions. Fluorocarbons and polyolefins are quite low in polar functionality and thus have

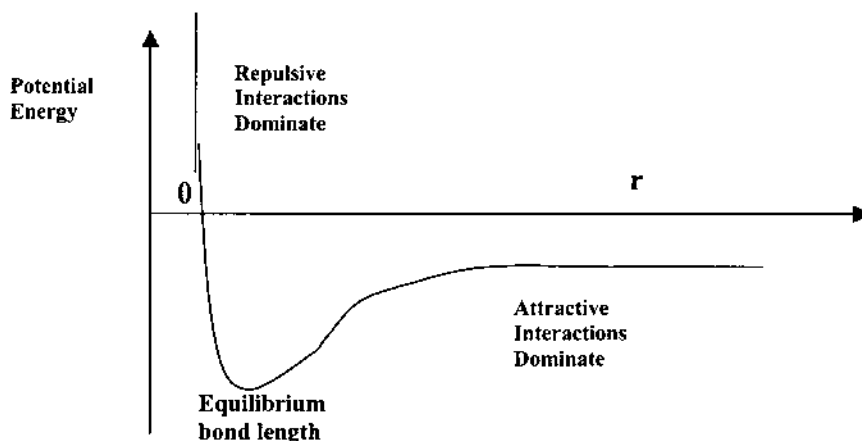

FIG. 23 A typical potential energy versus distance curve showing that there is an optimal distance for maximum attractive interaction.

relatively low surface energies. Their interactions arise only from the nonpolar (van der Waals) forces that are low in magnitude, which makes strongly adhesive bonds quite difficult to achieve. Surface tension also varies with temperature in a manner that relates to fundamental intermolecular characteristics of the

TABLE 8 Attractive Interaction Energies and Their Distance Dependence

| Type of interaction            | Force (kJ/mol) | Distance dependence      | Equilibrium length (Å) |
|--------------------------------|----------------|--------------------------|------------------------|
| Covalent                       | 60–800         | Complicated, short range | 0.8–3                  |
| Metallic                       | 100–350        | Complicated, short range | 2–6                    |
| Electrostatic—charge/charge    | 600–1200       | 1/r                      | 2–4                    |
| Electrostatic—charge/dipole    | —              | 1/r <sup>4</sup>         | —                      |
| Hydrogen bond                  | —              | 1/r <sup>2</sup>         | 3 (highly directional) |
| Dipole/dipole (Keesom)         | ~20            | 1/r <sup>6</sup>         | 2–4                    |
| Dipole/nonpolar (Debye energy) | ~20            | 1/r <sup>6</sup>         | 2–4                    |
| London dispersion              | ~40            | 1/r <sup>6</sup>         | 4–6                    |

Source: Refs. 59 and 60.

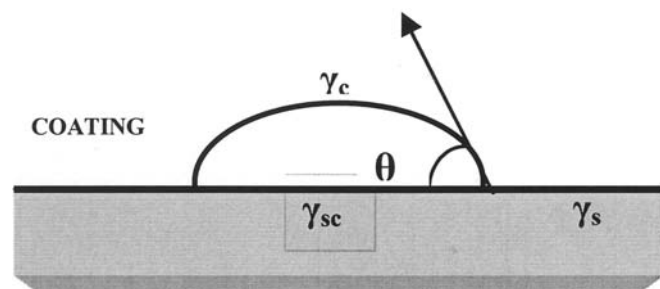

Fig. 24 Illustration showing the characteristic contact angle,  $\theta$ , of a drop of liquid on a solid substrate.

TABLE 9 Interfacial Energies: Total and the Components

| Polymer or solvent             | Total surface energy (dyne/cm) | Polar component (dyne/cm) | Nonpolar (dispersive) component (dyne/cm) | Reference |
|--------------------------------|--------------------------------|---------------------------|---|-----------|
| Poly(tetrafluoroethylene)      | 18.0                           | 1.1                       | 16.9                                      | 9         |
| Etched                         | 50.6                           | 14.5                      | 36.1                                      |           |
| PP                             | 30.2                           | 0.0                       | 30.2                                      | 9         |
| Flame-treated PP               | 37.6                           | 4.1                       | 3.5                                       |           |
| LDPE                           | 33.1                           | 1.1                       | 32.0                                      | 9         |
| Poly(vinyl fluoride)           | 36.7                           | 0.0                       | 36.7                                      | 9         |
| PET                            | 41.3                           | 3.5                       | 37.8                                      | 9         |
| PET                            | 47.3                           | 4.1                       | 43.2                                      | 61        |
| Poly(methylene oxide)          | 33.3                           | 11.5                      | 21.8                                      | 61        |
| Polystyrene                    | 42.0                           | 0.6                       | 41.4                                      | 61        |
| Poly(vinyl chloride)           | 41.5                           | 1.5                       | 40.0                                      | 61        |
| Poly(vinyl fluoride)           | 36.7                           | 5.4                       | 31.3                                      | 61        |
| Poly(methyl methacrylate)      | 40.2                           | 4.3                       | 35.9                                      | 61        |
| Polyamide (nylon 6,6)          | 47.0                           | 6.2                       | 40.8                                      | 61        |
| Poly(bisphenol carbonate) (PC) | 45.0                           | —                         | —   | 61        |
| Water                          | 72.8                           | 51                        | 21.8                                      | 61        |
| Glycerol                       | 63.4                           | 26                        | 37.0                                      | 61        |
| Aniline                        | 42.9                           | 18.7                      | 24.2                                      | 61        |
| Decalin                        | 29.9                           | 0                         | 29.9                                      | 61        |
| n-hexane                       | 18.4                           | 0                         | 18.4                                      | 61        |



material. Table 10 provides examples of the total surface tension at several temperatures for several materials.

### 3.3 Interdiffusion

Both small and macromolecules of a coating formulation can penetrate into the substrate and maximize interfacial contact and polymer chain entanglement for macromolecules. The thermodynamics and kinetics of polymer interdiffusion are thus important considerations in understanding this aspect of adhesion. While thermodynamics are set by the chemistry and dictate the theoretical equilibrium state of the system, various experimental considerations can improve practical kinetics and bring a system closer to the ideal. For example, raising the temperature increases diffusion by reducing viscosity, with especially large effects occurring if the temperature change traverses the  $T_g$  and/or  $T_m$  of the material. Enhancements in interdiffusion can also be achieved by (1) the addition of a plasticizer—which effectively reduces the  $T_g$  of the coating; (2) using a lower molecular weight polymer—which reduces the viscosity at all temperatures; and (3) increased intermolecular interactions—which can create a stronger chemical driving force toward diffusion.

### 3.4 Surface Contamination

Surface contamination can significantly change the nature of surface forces and be both a source of error in surface-tension measurements and a detriment to

**TABLE 10** Surface Tensions of Polymers at Three Temperatures

| Polymer                      | Molecular weight | $\gamma_{\text{total}}$ (20°C) | $\gamma_{\text{total}}$ (140°C) | $\gamma_{\text{total}}$ (180°C) | Reference |
|------------------------------|------------------|--------------------------------|---------------------------------|---------------------------------|-----------|
| Linear polyethylene          | Mw = 67,000      | 35.7                           | 28.8                            | 26.5                            | 62        |
| Branched polyethylene        | Mn = 7,000       | 33.7                           | 26.5                            | 24.1                            | 62        |
| Atactic polypropylene        | Mn = 3,000       | 28.3                           | 23.5                            | 21.9                            | 62        |
| Poly(isobutylene)            | Mn = 2,700       | 33.6                           | 25.9                            | 23.4                            | 62        |
| Poly(methyl methacrylate)    | Mv = 3,000       | 41.1                           | 32.0                            | 28.9                            | 62        |
| Poly(chloroprene)            | Mv = 30,000      | 43.6                           | 33.2                            | 29.8                            | 62        |
| Poly(ethylene terephthalate) | Mn = 25,000      | 44.6                           | 36.7                            | 34.2                            | 62        |
| Polycarbonate (bisphenol A)  | Unspecified      | 42.9                           | 35.7                            | 33.3                            | 62        |
| Polystyrene                  | Mn = 44,000      | 40.7                           | 32.2                            | 29.2                            | 62        |
| Polyacrylonitrile            | —                | 44                             | —                               | —                               | 61        |
| Nylon 6                      | —                | 40–47                          | —                               | —                               | 61        |
| Nylon 6,6                    | —                | 39.3                           | —                               | —                               | 61        |
| Nylon 10,10                  | —                | 28.5                           | —                               | —                               | 61        |

good adhesion. One important example of surface contamination is mold-release agents that are designed to bloom to the surface and facilitate demolding, but that must be completely removed prior to coating to ensure good adhesion. Contaminated shop oils from machinery and conveyor belts and human body oils from unprotected handling are even more pervasive contaminants. Airborne contamination, especially silicon aerosols used for lubrication, can enter plant heating/ventilation/air conditioning units and contaminate the part surface. For this reason, thorough cleaning of any potentially contaminated surface is required prior to any interfacial measurements or coating.

### 3.5 Weak Boundary Layers

Even when adhesion across an interface is excellent, problems can still arise just below the substrate surface. In the weak boundary layer scenario, polymeric surface species remain attached to the coating, but fail cohesively just below the surface. There are a variety of reasons for this:

- Inherent low-entanglement energies that can result from a lack of polar interactive energies (characteristic of low-surface-energy polymers)
- Migration to the surface of low molecular-weight species that are below the minimum molecular weight for entanglement
- Overoxidation and molecular weight degradation of the surface during chemical and/or plasma treatments
- Low cohesive interactions in a multiphase material because of poor miscibility

One clear illustration of the importance of this issue is the recent reports of improved adhesion to polyolefins produced by single-site catalytic polymerization of ethylene and propylene. Single-site catalysis yields materials of a narrower molecular weight distribution. Reports of these materials suggest that the reduced content of species below the entanglement molecular weight is responsible for their enhanced adhesion (9).

### 3.6 Surface Morphology and Microstructure

Because the diffusion rates, chemical speciation, and mechanics of a material are all a function of the extent of crystallinity of a single phase and of the morphology in a blend, crystallinity (microstructure) and morphology must be taken into consideration for adhesion. A good illustration is found in TPO, for which adhesion has been found to depend on molding conditions such as melt temperature, distance from the gate, aging, and heat treatment. Careful analysis found that these experimental factors correlated to the surface content of elasto-

mer and to the level and type of PP crystallization. In turn, these affected adhesion by changing the viscoelastic component of the energy dissipation mechanism (10,11).

### 3.7 Adhesion Promoters

Adhesion promoters are most frequently used with low-energy surfaces. Adhesion promoters for polyolefins are typically chlorinated polyolefins (CPO), which are formulated at less than 20% solids in either nonaqueous solvent or water-borne dispersions. The level of chlorination and molecular weight are the critical CPO parameters, with typical commercial values of about 20% chlorine content and a molecular weight of about 15,000. The mechanism for enhanced adhesion appears to be only the improved wetting of the polyolefin surface—*without* the CPO penetrating into the coating, because spectroscopic analysis has shown that adhesive failure occurs at a sharp substrate/CPO interface (11). The superior mechanical properties of the CPO primed system, in comparison to that of only the olefinic substrate, are believed to improve adhesion through improved stress transfer across two new interfaces (12). Performance was also sited to be a strong function of the CPO film drying temperature, with higher temperature promoting improved bonding through enhanced diffusion and polymer interpenetration (13).

#### 3.7.1 Surface Treatments

When native interfacial forces are not sufficient, and priming not appropriate, surface treatments such as those listed in Table 11 are called upon. Nearly all polyolefin, and some polar engineering polymers, are prepared by one of these techniques. The enhancement mechanisms that result from these treatments include (1) increasing the surface area and thus the total interfacial bonding energy; (2) improving mechanical interlocks by surface roughening; and (3) changing the nature of the surface states to those having higher polarity and thus stronger interactions. Not listed in this table are coupling agents (adhesion promoters), which can be very effective because they typically are designed to create a covalent bond.

Independent of the choice of the particular surface treatment, each technique must be executed with precision to be effective. A good example is the study by Rzad et al., who explored the details of the effects of the intensity and duration of both UV and plasma surface treatments on adhesion to PBT and its blends with PC and PMMA. Their analysis included measurements of the wetting angle and identification of surface species using x-ray photoelectron spectroscopy (XPS). They found that adhesive strength varied with exposure time (as expected) and also with the time between treatment and testing. Surprisingly,

TABLE 11 Comparison of Technologies for Bonding Low Surface-Energy Polymers

| Technology                  | Ultimate bond strength                 | Advantages  | Disadvantages   | Capital costs | Cost per part | Potential for future development                    |
|-----------------------------|--|---|---|---------------|---------------|---|
| Thermal methods             | High                                   | Fast fixturing, no chemicals required                       | Only bonds simple parts, cannot bond dissimilar materials, requires precisely matched surfaces, restricts part design | High          | Medium        | Low   |
| Chemical surface treatments | High                                   | Universal for most plastics                                 | Slow off-line batch process; hazardous chemicals involved   | Medium        | High          | Low   |
| Flame treatment             | High                                   | Universal for most plastics                                 | Capital investment for the flame-treating equipment, additional step  | Medium        | Medium        | Medium  |
| Plasma treatment            | High                                   | Universal for most plastics, clean process, no chemicals    | Slow off-line batch process; depends on distance, hence often not uniform over part surface, for example, TPO fascia  | High          | High          | Medium  |
| Polymer modification        | Medium                                 | Versatile, many different reactive groups can be introduced | Slow off-line batch process, the modifying polymer often is detrimental to performance                                | High          | High          | Medium  |
| Surface primers             | Very high, to the limit of the plastic | Simple process  | Only for cyanoacrylates, volatile solvents in primer, extra process step  | Low           | Medium        | Low for cyanoacrylates, good for reactive acrylates |

Source: Ref. 63.

the optimal time for coating was one week after surface treatment. This somewhat unexpected behavior was believed to originate in slow rearrangement of the surface species. The maximum bonding was found to occur when the surface was populated with  $-OH$  or  $-CHO$ , but not with ester linkages. This was explained by the specific chemical speciation required for substrate reaction with isocyanate groups in the polyurethane coating (14). This study points out that covalent interactions should be expected to need chemical “tuning” to ensure that the proper surface species are provided to match the reactive group in the coating.

### 3.8 Adhesion to Low-Energy Polyolefin Surfaces

The importance of low-cost material solutions is the primary reason to overcome the difficulty of coating polyolefin surfaces. In addition to the use of adhesion promoters and of the flame and plasma surface treatment previously discussed, two additional potential alternatives that are specific to polyolefins are discussed in the following text.

#### 3.8.1 Surface Functionalization Through Bulk Modification

The addition of polar groups to the polyolefin backbone has been a widely explored technique for improved adhesion. The success of this approach relies on the ability to place a sufficient concentration of polar groups on the surface of the formed part. This surface concentration correlates to the bulk concentration combined with the mobility of the polar-modified polymer in the melt. Bergbreiter et al. demonstrated that blending block co-oligomers of PP and tert-butyl acrylate into unmodified PP produced a surface that provided surface acid functionality after hydrolysis (12). Improved wetting by the addition of the polar maleic anhydride group directly onto PE was found to depend on the polar content of the material, processing conditions, and the extent to which the anhydride group was hydrolyzed after substrate formation. These materials were also found to offer better adhesion to a polar substrate than the same surface treated with oxygen plasma (15). Hailat combined a maleated PP and polyetheramine that reactively coupled in the melt to produce a part having excellent adhesion to polyurethanes (16). Similarly, maleated polyolefins have been reacted with polyamides and their copolymers to reactively produce a polar polyolefin in the melt that has improved adhesion (17,18). Although these chemistries have been demonstrated at laboratory to pilot scale, none are currently practiced commercially. Issues that remain include the cost of the new polymers in comparison to use of adhesion promoters, and the fact that such treatments reduce the heat-distortion temperature of the polymer below that dictated by paint oven temperatures for typical one-component coatings (19). Compared to one-component systems, two-component systems cure at temperatures that do not compromise the physical properties of the substrate, but do cost significantly more.

#### 4 ELECTROSTATIC PAINTING

Plastics play an increasingly important role in automotive exteriors due to their light weight, which enables compliance with fuel efficiency standards, and high level of design and processing flexibility. As discussed previously, consumers demand that automotive components have a high aesthetic value. For exterior vehicle body panels, alternatives to the painting process, such as molded-in coloring and in-mold laminates, have not yet produced a final appearance that is uniformly acceptable to both customers and the manufacturing industry. The desire for a Class A finish thus keeps traditional painting techniques as the most widely practiced option for surface finishes. Coating the parts with high-quality paints is thus an absolute requirement for commercial success. This finishing step is very expensive, with coating costs frequently equal to that of the unfinished part. Efficient coating is therefore critical for continued commercial viability in this application.

A common figure of merit for the painting process is transfer efficiency (TE), which is the weight of paint delivered to the part divided by the total weight that left the paint gun per part. Although each painting technique covers a range of efficiencies because of differences among painting shops, there are fundamental efficiency differences between the different processes. Table 12 shows that electrostatic painting with automatic air atomization of the paint has the potential to be the most efficient, and thus the lowest cost, coating technique.

In the electrostatic painting process, paint particles are accelerated toward an electrically grounded substrate by application of a relatively large applied voltage, typically 20,000 to 100,000 V. The voltage attracts the charged paint particles to the substrate and then drives the charge-dissipating electrical current to the ground plane (64). The applied voltage also directs particles that are not in the direct line-of-sight toward the substrate, an effect that has been termed

**TABLE 12** Automotive Painting Techniques and Characteristic Transfer Efficiencies

| Atomized spray type | Charging      | Paint type    | Typical transfer efficiency (%) |
|---------------------|---------------|---------------|---------------------------------|
| Manual or air       | None          | Waterborne    | 30                              |
| Manual air          | None          | Solvent borne | 42                              |
| Manual air          | Electrostatic | Solvent borne | 62                              |
| Automatic air       | Electrostatic | Solvent borne | 90                              |

Source: Ref. 64.

“wrap” or “paint wrap.” This reduction of “blow-by” is a significant process enhancement because it improves aesthetics by increasing paint uniformity in highly curved regions and edges.

The electrically insulating nature of plastic substrates necessitates that the part be coated with a conductive primer for electrostatic painting. (For many substrates, such as polyolefins, this conductive primer is also formulated to improve paint adhesion.) Paint-transfer efficiencies realized with conductively primed plastic substrates, however, are often below the values seen with metal substrates. The combined under-performance of conductive primers and the high cost of painting has led to an interest in the use of conductively modified polymer substrates as an alternative approach for grounding plastic parts (20–30). The potential advantages associated with the use of conductively modified polymers versus conductively primed substrates have been discussed widely in the literature. A list of these benefits is presented in Table 13.

#### 4.1 Requirements for Conductively Modified Polymers

The first issue in the use of conductively modified polymers for electrostatic painting is the establishment of a target conductivity for maximum transfer efficiency. Theoretically, the charge on the particle must be removed from the substrate at approximately the same rate at which additional charged particles are deposited. If the rate of charge removal is less than the rate of deposition, residual charges will build on the surface and will ultimately repel further incoming particles. The practical optimal substrate conductivity is the experimental value at which the transfer efficiency for the conductive plastic equals that realized with the most conductive material available—a metal. Metal substrates typically offer transfer efficiencies in the range of 85% to 95%. This value is not 100% due to phenomena such as blow-by of particles at distances from the substrate edge that are too great for attraction by the applied field, and recoil of the incoming particles as they “bounce away” from the surface upon impact.

Experiments to determine the optimal target conductivity value have been performed on both small plaques in paint labs and on large injection molded parts in commercial painting shops. Figure 25 depicts the detailed experimental design for mounting test small plaques in a robotic paint lab and the resultant paint coverage on both the front and back for conductive and nonconductive plaques, with and without a full grounding plane. The distribution of paint on the plaques shows (1) the front of the conductive substrate has excellent paint coverage at all distances from the ground clip because it is uniformly well grounded due to its electrical conductivity; (2) the back side of conductive parts show excellent wraparound, which is driven by the field; and (3) the nonconductive parts have no measurable paint coverage, except at positions that are in intimate contact with the ground plane.

**TABLE 13** Potential Benefits of Conductively Modified Polymer Substrates in Electrostatic Painting

| Category            | Saving   | Comments   |
|---------------------|--|--|
| Material savings    | Elimination of conductive primer   | Adhesion still an issue for certain polymers, especially those with low surface energy.  |
| Process based       | Increased TE = less paint used   | Direct cost reduction.   |
|                     | Increased TE = faster painting rate = higher productivity<br>Reduced complexity of grounding buck because of higher available surface area for electrical contact during grounding | Lower cost grounding bucks because of reduction in complexity. For example, bucks made of wire mesh could be used.<br>Lower buck weight results in faster heating cycle in paint-bake ovens. |
| Quality based       | Better "wrap"  | Reusable bucks through reduction of available contact surface area during grounding.<br>Lower overall paint usage through effective coverage around corners and at edges.                    |
|                     | Fewer trapped dirt particles resulting from reduced static attraction  | Increases productivity and reduces cost resulting from rework.   |
| Environmental based | Higher TE = less sludge  |  |
|                     | Higher TE = lower emissions  | This may have significant impact depending on how highly the emission system of a particular shop is used.   |

This excellent transfer efficiency for well-grounded nonconductive parts has been attributed to the field-assisted mechanism of charge dissipation, as shown in Figure 26. This mechanism was first detailed for the electrostatic painting process by Garner and Elmoursi in the early 1990s (30–34). Image forces, which have a charge that is the opposite of the paint particle, are created at the surface of the insulating substrate to neutralize the charge. The charge dissipation time constant for movement of this image charge through the substrate is a function of the dielectric and conductive properties of the material.



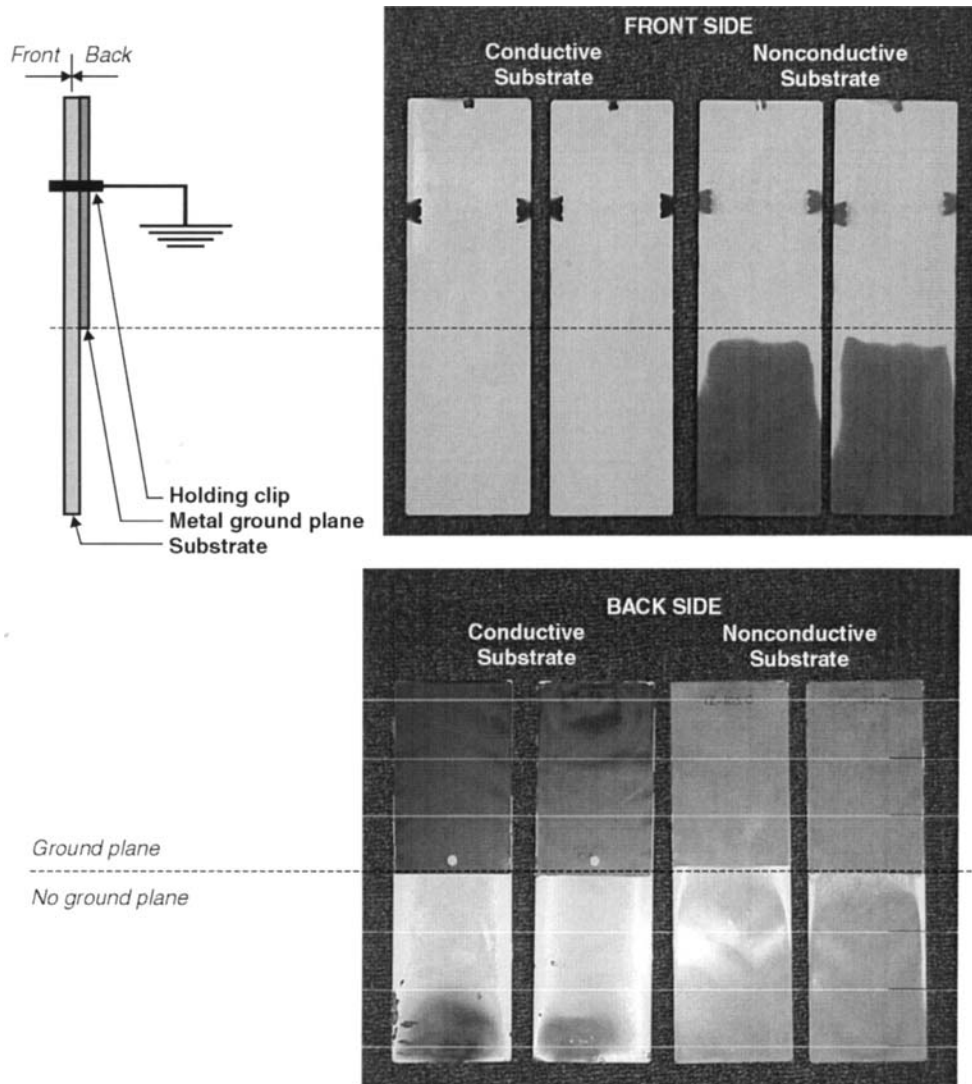

FIG. 25 Paint pattern on conductive and nonconductive substrates.

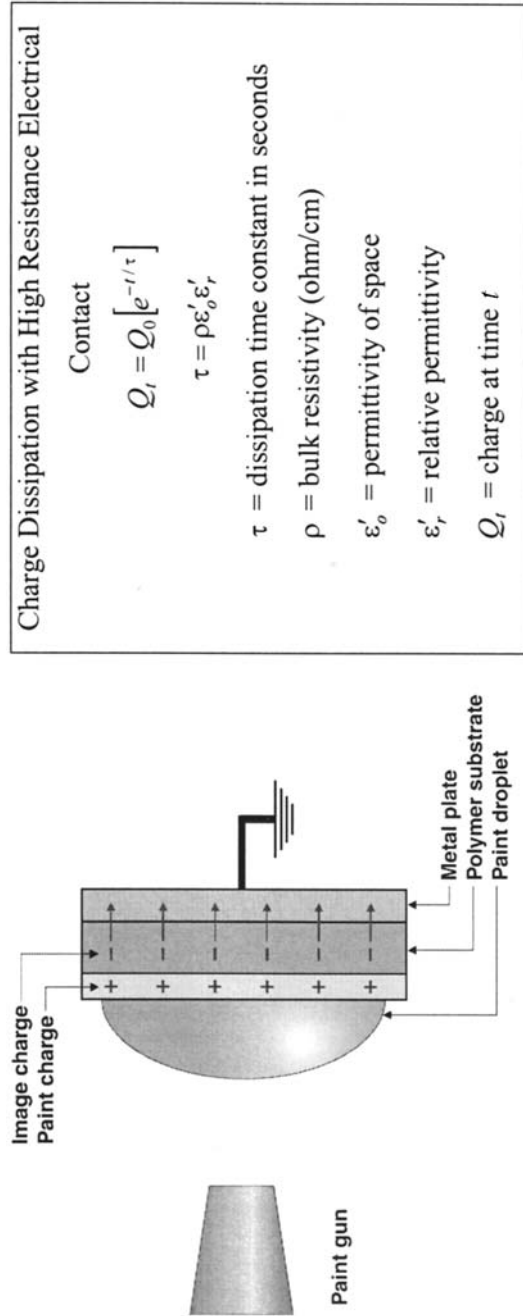

FIG. 26 Charge dissipation through a highly resistive material.

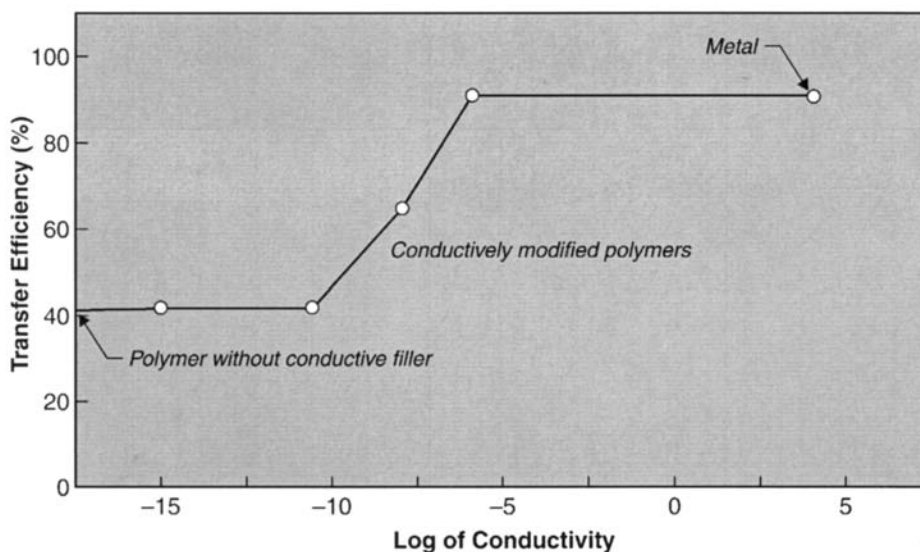
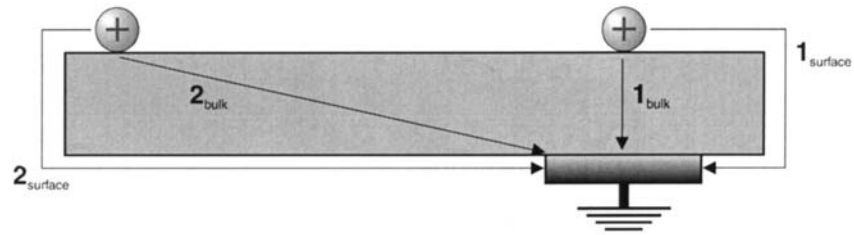

FIG. 27 Electrostatic paint transfer efficiency versus substrate conductivity for plaques painted in a test laboratory.

Polar materials will have a faster inherent dissipation constant than nonpolar materials because of their higher dielectric constant. Such charge dissipation processes that occur with highly resistive substrates produce characteristically low dissipation currents, in comparison to those of a conductive substrate.

Figure 27 plots the transfer efficiency versus part conductivity for plaques of polymers having various conductivities. For these experiments, transfer efficiencies were evaluated by paint thickness (theoretical yield is calculated based on percent solids in the paint and time of plaque exposure to the paint, which is sprayed at a particular delivery rate). A plateau of transfer efficiency versus substrate conductivity occurs in the region of approximately  $10^{-5}$  S/cm, which shows that paint transfer efficiency equivalent to that of metal can be observed at levels of polymer conductivity significantly below metallic (35).

Practical aspects to grounding a conductively modified part in a painting shop are of equal importance as the theory. Figure 28 illustrates that a charge will typically travel a shorter distance if it moves toward the grounding clip through the bulk of a semiconductor instead of along the surface. However, it is not the physical distance, but instead the total resistance of the path that is the determining feature for current distribution. The resistance of any given path is the average resistivity of the material traversed multiplied by the distance traveled. If substrate bulk conductivity is equal to or greater than that of the



$$V_{\text{total}} = I \cdot R_x$$

$$I = V_{\text{total}} / R_x$$

$$R_x = (\text{resistivity})(\text{distance traveled})$$

FIG. 28 Charge dissipation currents divide across all available paths using relative power (IR drop) losses just as they would in a parallel electrical circuit.

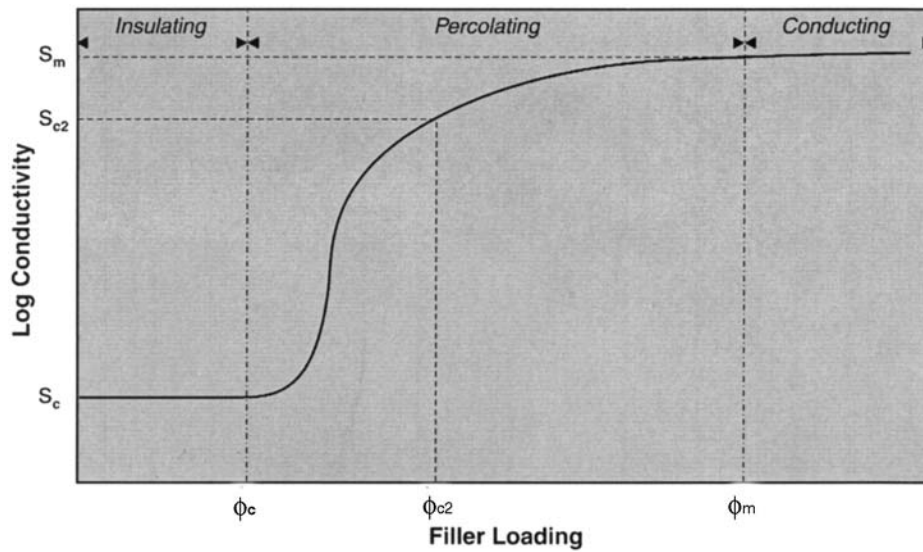

FIG. 29 Theoretical Percolation Curve. (From Ref. 39.)

conductive primer, discharge currents will travel through the bulk (the shorter path to ground). Practical details such as the shape of the part, the placement of grounding clips, and the number of grounding clips can clearly affect the relative merits of the various charge dissipation routes, and thus the optimal conductivity value. The published literature consensus of a target conductivity for electrostatic painting appears to be a value of about  $10^{-5}$  to  $10^{-6}$  S/cm (35).

#### 4.2 Preparation of Conductively Modified Plastics

Typical fillers employed in the preparation of conductive polymers are conductive carbon powders, fibers, and nanofibers. The literature offers general guidelines and many experimental examples of composite preparation. An important guiding principal for all systems is percolation theory, which is used to predict the amount of filler required to make a single phase material conductive through filler addition. This theory is based on the universal experimental finding that a critical state exists at which the fillers in an insulating matrix suddenly connect with each other to create a continuous conductive network, as shown in Figure 29.

The percolation threshold,  $\phi_c$ , is the filler loading level at which the polymer first becomes conductive, which is generally considered to be a value of about  $10^{-8}$  S/cm. Comprehensive experimental and theoretical treatments describe and predict the shape of the percolation curve and the basic behaviors of composites as a function of both conductive filler and the host polymer characteristics (36–38). A very important concept is that the porous nature of the conductive carbon powders significantly affect its volume filling behavior. The typical inclusive structural measurement for conductive carbon powder porosity is dibutyl phthalate absorption (DBP) according to ASTM 2314. The higher the DBP, the greater the volume of internal pores, which vary in size and shape. The crystallinity of the polymer also reduces the percolation threshold, because conductive carbons do not reside in the crystallites but instead concentrate in the amorphous phase. Eq. (2) describes the percolation curve (39).

$$\phi_c = (1 - \zeta) \left( \frac{1}{1 + 4\rho v} \right) \quad \text{Eq. (2)}$$

where:

- $\phi_c$  = volume at percolation onset
- $\rho$  = density of carbon (taken as 1.82)
- $v$  = DBP absorption on crushed carbon in  $\text{cm}^3/\text{g}$
- $\zeta$  = crystalline volume fraction of the polymer

Table 14 compares the theoretical and experimental results for percolation of two conductive carbon powders in a PP of two different melt flows, 4 and 44 g/10 min, when prepared by two melt-processing techniques, compression

**TABLE 14** Comparison of Theoretical and Experimental Electrical Percolation Behavior for PP

| PP Melt flow<br>(g/10 min) | Carbon<br>type      | Predicted<br>percolation<br>threshold<br>(%) | Sample<br>preparation | Experimental<br>percolation<br>threshold ( $\sigma_c$ )<br>(wt %) | Experimental<br>loading for<br>$10^{-5}$ S/cm<br>(wt %) |
|----------------------------|---------------------|--|-----------------------|---|---|
| 44                         | XC-72 <sup>a</sup>  | 3.0  | IM <sup>c</sup>       | 10.0  | 11.0  |
|                            | XC-72               | 3.0  | CM <sup>d</sup>       | 3.0   | 5.0   |
| 44                         | EC-600 <sup>b</sup> | 1.1  | IM                    | 3.0   | 3.0   |
|                            | EC-600              | 1.1  | CM                    | <1.0  | <2.0  |
| 4                          | XC-72               | 2.4  | IM                    | 12.0  | 14.0  |
|                            | XC-72               | 2.4  | CM                    | 6.0   | 7.0   |
| 4                          | EC-600              | 0.9  | IM                    | 2.0   | 2.0   |
|                            | EC-600              | 0.9  | CM                    | 2.0   | 2.0   |

<sup>a</sup>XC-72 obtained from the Cabot Corporation, DBP = 178; <sup>b</sup>EC-600 obtained from Akzo Nobel, DBP = 495; <sup>c</sup>IM = Injection molded; <sup>d</sup>CM = Compression molded.

Source: Ref. 39.

and injection molding. The experimental thresholds did not match the theoretical predictions when the sample was injection molded, under any conditions. However, the compression-molded samples showed generally better agreement between theory and experiment, especially when polymer viscosity was low. Further, agreement with theory was found to be independent of the level of carbon porosity, as evidenced by similar levels of agreement between carbons of two distinctly different DBP values. The excellent predictive quality when the polymer has low viscosity and the composite experiences ample time in the melt state under zero shear (as with compression molding) suggests that flocculation of the carbon and formation of a preferred carbon network structure are rate limiting in morphology development (39).

In conductive polymer *blends*, for example, TPO, another phenomenon must be taken into account—the localization of the conductive filler in only one of the available phases. Such composites characteristically acquire conductivity at lower filler loading levels than would be achieved by either of the two individual polymer phases. This advantaged percolation using localization of filler in a single phase of a polymer blend is called “double percolation.” Filler localization has been reported in a large number of conductive blends (40–54).

The driving force for localization is believed to be the thermodynamics of polymer/filler interaction, as described by Young’s equation. Sumita et al. have calculated a carbon black wetting coefficient,  $\omega_{p_1-p_2}$ , Eq. (3), from Young’s equa-

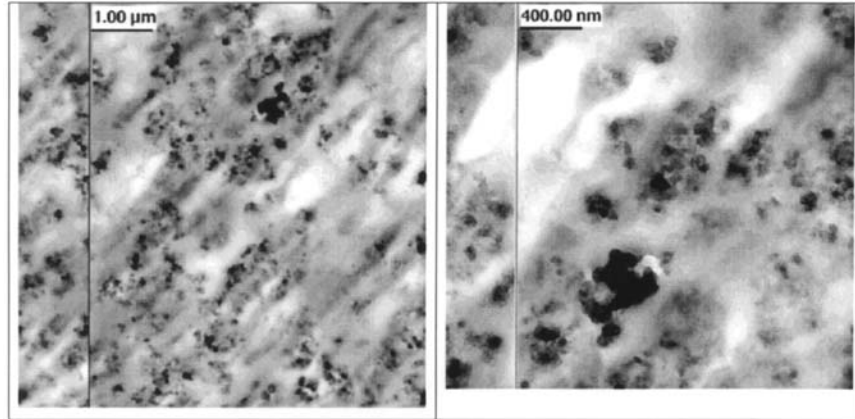

FIG. 30 Transmission electron micrograph (TEM) of the morphology of a conductive TPO.

tion in order to predict the thermodynamically controlled location of the filler in a binary blend (20,36).

$$\omega_{p_1-p_2} = \frac{\gamma_{c-p_2} - \gamma_{c-p_1}}{\gamma_{p_1-p_2}} \quad \text{Eq. (3)}$$

where:

$\gamma_{c-p_1}$  = interfacial tension between conductive carbon and polymer 1

$\gamma_{c-p_2}$  = interfacial tension between conductive carbon and polymer 2

$\gamma_{p_1-p_2}$  = interfacial tension between polymer 1 and polymer 2

$\theta$  = contact angle of the polymer on the carbon

*Prediction:*

$\omega_{p_1-p_2} > 1$  = carbon in the  $P_1$  phase

$\omega_{p_1-p_2} < -1$  = carbon in the  $P_2$  phase

$-1 < \omega_{p_1-p_2} < +1$  = carbon at the  $P_1/P_2$  interface

In blends of polar and nonpolar polymers, the carbon typically resides in the more polar phase. For blends of low-surface-energy polymers, such as polyolefins, there are conflicting accounts of positioning of the carbon (21,39,55,56). It has been reported that conductive fillers are least likely to reside in a PP phase, which is related to its exceptionally low surface energy.

When the conductive filler localizes in a minor phase of a blend, that phase must be at least partially continuous for the composite to be globally conductive. Morphology is often adjusted to keep a conductive minor phase volume to a minimum, while maximizing continuity in an attempt to minimize the additional cost incurred for the conductive filler. For example, in a rubber-modified polypropylene, the carbon resides in the minor rubber phase. Figure 30 shows that the minor phase rheology of a conductive TPO. For this, the conductive carbon resides fully in the elastomer phase, which is the dark region. The minor elastomer phase morphology has been adjusted to be somewhat lamellar so that the conductive domains can be continuous within the composite at low-volume fractions.

## REFERENCES

1. Chem Eng News 58(40):29, 1980.
2. BRGTownsend Inc., P.O. Box F, Suite 130, 500 International Drive North, Mount Olive, NJ 07828.
3. Automotive Plastics Report—2000, Market Search Inc.
4. RW Carpenter. Electroplating: back to the basics. The Society of Plastics Engineers Regional Educational Technical Conference. March 1992.
5. Standards and guidelines for electroplated plastics. American Society of Electroplated Plastics. Englewood Cliffs, NJ: Prentice-Hall, Inc, 1984.
6. B Factor, T Russell, M Toney. Physical Review Letters, 1991, p. 1181.
7. Merriam-Webster's Collegiate Dictionary, Tenth Edition. Merriam-Webster, Inc. 2001, p. 14.
8. S Granick. MRS Bulletin 33–36, 1996.
9. D Brewis, D Briggs. Polymer 22:7–16, 1981.
10. RA Ryntz. The Influence of Surface Morphology on the Adhesion of Coatings to Thermoplastic Polyolefins Under Stress. In: The Annual Meeting of the Adhesion Society, 18th. 1995.
11. E Tomasetti, R Legras, B Henri-Mazeaud, B Nysten. Polymer 41:6597–6602, 2000.
12. D Bergbreiter, B Walchuk, B Holtzman, H Gray. Macromolecules 31:3417–3423, 1993.
13. P Schmitz, J Holubka. Journal of Adhesion 48:137–148, 1995.
14. S Rzad, DC, M Burrell, J Chera. In: SAE International Congress and Exposition. Detroit SAE, 1990.
15. R Bongiovanni, BG, G Malucelli, A Priola, A Pollicino. J Materials Science 33: 1461–1464, 1998.
16. M Hailat, HX, K Frisch. J Elastomers and Plastics 32:195–210, 2000.
17. T Ouhadi, JH, U.S. Patent 5,843,577, 1998.
18. T Ouhadi, JH, PCT WO 95/26380, 1995.
19. B Miller. Plastics World 15, 1996.
20. J Helms. Electrostatic painting of conductively modified injection molded thermoplastics. In: Coating Applications of Specialty Substrates. Society of Manufacturing Engineers, 1995.



21. J Helms. Conductive TPOs for improved painting efficiency of bumper fascia. In: TPOs in Automotive Conference. 1996.
22. T Derengowski, EB, J Helms. In SAE. 1998.
23. D Edge, DG, C Doan, S Kozeny, P Kim. The benefits of conductive TPO for improving the painting of automotive part. In: TPOs in Automotive. 1998.
24. J Pryweller. *Plastics News*. 4, 1997.
25. *Plastics Engineer*. 32, 1998.
26. *VTA News*. 2, 1993.
27. B Miller. *Plastics World*. 73–77, 1996.
28. JD Gaspari. *Plastics Technology*. 14–15, 1997.
29. B Miller. *Plastics World*. 15, 1996.
30. H Scobbo, DG, T Lemmen, V Umamaheswaran. In: SAE Conference. 1998.
31. D Garner, AE. *J Coatings Technology* 63(803):33–37, 1991.
32. D Garner, AE. *J Coatings Technology* 64(805):39–44, 1992.
33. C Speck, AE. *Transactions on Industry Applications* 27(2):311–315, 1991.
34. A Elmoursi. In: IEEE Industry Applications Society Annual Meeting. 1991.
35. K Sichel. *Carbon Black-Polymer Composites—The Physics of Electrically Conducting Composites*. New York: Marcel Dekker, 1982.
36. N Probst. *Carbon Black—Science and Technology, Second Edition—Conducting Carbon Black*. ch. 8, 1993.
37. A Medalia. *Rubber Chem and Technology* 59:432, 1985.
38. S Babinec, RM, R Lundgard, R Cieslinski. *Advanced Materials* 12(23):1823–1834, 2000.
39. K Miyasaka, KW, E Jojima, H Aida, M Sumita, K Ishikawa. *J Materials Science* 17:1610, 1982.
40. S Asai, KS, M Sumita, K Miyasaka. *Polymer Journal* 24(5):415, 1992.
41. M Sumita, KS, S Asai, K Miyasaka, H Nakagawa. *Polymer Bulletin* 25:265, 1991.
42. G Geuskens, E DK, S Blacher, F Brouers. *European Polymer Journal* 27:1261, 1991.
43. F Gubbels, RJ, Ph Teyssie, E Vanlathem, R Deltour, A Calderone, V Parente, J Bredas. *Macromolecules* 27:1972, 1994.
44. F Gubbels, SB, E Vanlathem, R Jerome, R Deltour, F Brouers, Ph Teyssie. *Macromolecules* 28:1559, 1995.
45. B Soares, FG, R Jerome, Ph Teyssie, E Vanlathem, R Deltour. *Polymer Bulletin* 35:223, 1995.
46. M Sumita, KS, S Asai, K Miyasaka. In: Sixth Annual Meeting—PPS. Nice, France, 1990.
47. F Gubbels, RJ, E Vanlathem, R Deltour, S Blacher, F Brouers. *Chem Materials* 10: 1227, 1998.
48. R Tchoudakov, OB, M Narkis. *Polymer Networks Blends* 6:1, 1996.
49. M Narkis, RT, O Breuer. In ANTEC 95 1995.
50. R Tchoudakov, OB, M Narkis, A Siegmann. *Polymer Engineering and Science* 36(10):1336, 1996.
51. C Zhang, HH, X Yi, S Asai, M Sumita. *Compos Interfaces* 6:227, 1999.
52. J Feng, CC. *Polymer* 41:4559, 2000.
53. A Ponomarenko, VS, N Enikolopyan. *Advances in Polymer Science* 126, 1996.
54. R Lundgard, SB, R Mussell, A Sen. U.S. Patent 5,844,037. 1998.

55. J Helms, EB, M Cheung. U.S. Patent 5,484,838. 1996.
56. No 38 was given in the original document.
57. RW Cahn. #8, 1993.
58. RA Ryntz. Adhesion to Plastics: Molding and Paintability. Polymer Surfaces and Interfaces Series. MW Urban, ed. Global Press, 1998, ch. 5.
59. J Israelachvili. Intermolecular & Surface Forces. 2<sup>nd</sup> ed. New York: Academic Press, 1997.
60. RA Ryntz. Adhesion to Plastics: Molding and Paintability. Polymer Surfaces and Interfaces Series. MW Urban, ed. Global Press, 1998, ch. 4.
61. DW Van Krevelen, PJH. Properties of Polymers, Their Estimation and Correlation with Chemical Structure. Amsterdam: Elsevier, 1976, p. 170.
62. J Bicerano. Prediction of Polymer Properties. 2<sup>nd</sup> ed. New York: Marcel Dekker, 1996, pp. 195–196.
63. Teltech Resources Network Corp. Adhesives Age 38–44, 1996.
64. BN McBane. Automotive Coatings Monograph, Federation of Cosities for Coatings Technology. Blue Bell, PA: SAE, 1987, p. 39.
65. IA Hamley. Introduction to Soft Matter, Polymers, Colloids, Amphiphiles, and Liquid Crystals. New York: Wiley, 2000.
66. RJ Young, PA Lovell. Introduction to Polymers, 2nd ed. London: Chapman and Hall, 1991, ch. 4.
67. MF Ashby. Materials Selection in Mechanical Design, 2nd ed. Oxford: Butterworth/Heinemann Publishing, 1999.
68. RN Howard, RJ Young. The Physics of Glassy Polymers, 2nd ed. London: Chapman and Hall, 1997.

# 2

## Plastics Processing

**Steven D. Stretch**

Emhart Fastening Teknologies, Inc., Mt. Clemens, Michigan, U.S.A.

### 1 INTRODUCTION

There are many reasons why plastics are today's materials of choice in a wide variety of applications. Plastic materials exhibit a broad and useful range of properties that can be fitted to any number of specific environments. Plastics are light, tough, strong, and environmentally resistant. It is their flexibility in processing, however, that has allowed plastics to enjoy the level of success they have achieved over the past 50 years.

Processing flexibility plays an important role in the overall plastics scenario in two ways. First, flexibility makes it possible for plastics to be used in the design of complex shapes that often cannot be produced with metals or other types of materials. Second, the precision and rapid cycling that can be realized in everyday manufacturing produces a compelling economic scenario that is difficult or impossible for other material-process combinations to match.

This chapter will provide a broad overview of the variety of plastics processes that are used to produce component parts. To gain a perspective, the relationship between raw materials and processes will be explored. Next, the fundamental physical mechanics of conversion will be outlined to develop an appreciation for how specific techniques are used to create processes that can be applied to achieve specific goals.

With this foundation in place, the factors used to make the underlying process selection decision will be discussed. Because the selection of process has important implications to coating of raw molded components, a method of incorporating coating considerations into the decision will be introduced.

Finally, an organized summary of key plastics conversion processes will be presented as an aid to making the best coating decisions for specific application scenarios.

## 2 OVERVIEW OF PLASTICS CONVERSION PROCESSES

The sheer number and variety of processes used for converting plastic raw materials into components can be daunting. Thankfully, it is possible to make sense of it all by understanding the nature of the raw materials that can be used and by viewing processes in terms of the basic physical mechanics that are involved for each. This approach will make it relatively easy to understand which materials can be used with what processes and what a given process is able to accomplish.

### 2.1 Raw Material Considerations

Plastic materials are based on hydrocarbons, a class of organic compounds that contain hydrogen and carbon. The primary source of hydrocarbons today is crude oil, although it is possible to produce them from coal, shale, or other forms of fossil fuel. It is also possible to produce hydrocarbons from other organic matter, such as cereal grains.

Hydrocarbons are interesting compounds because some of them lend themselves to reaction by *polymerization*. This type of reaction produces plastic materials from simple molecular building blocks. The building blocks combine into chains that result in polymer molecules that are very large (in atomic terms). The term *polymers* is from the Latin *poly* (meaning many) and *mers* (meaning units). So plastics are described as hydrocarbons that are composed of “many units.”

#### 2.1.1 Raw Material Form

The first source of processing variety comes into play when the question of when and how this polymerization reaction takes place. Raw materials may be liquid components or they may be solids in the form of powders, granules, or pellets. The raw materials may be presented for processing in a prepolymerized form (polyethylene or acrylonitrile/butadiene/styrene [ABS]), they may be in a partially reacted form (urethanes = polyols + isocyanates), or they may be in the state of their precursor raw materials (phenolics and alkyds).

The general path from hydrocarbons to molding materials is shown in graphical form in Figure 1. There are several considerations that determine the form that raw materials take.

*Physical Form of the Polymer Building Blocks.* The raw materials or units used to produce plastics are normally compounds that are in the form of

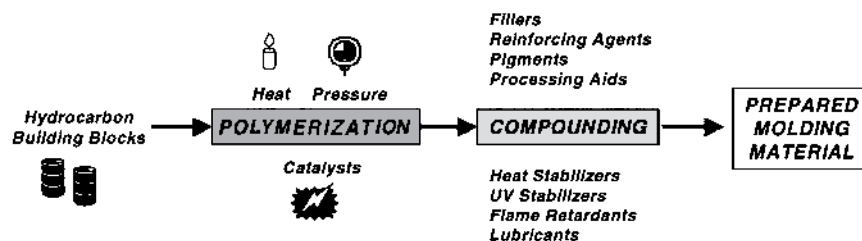

FIG. 1 Possible raw material path to produce a precursor to present for processing into molded parts.

liquids or gases. Because gases are difficult to handle and control, the reactions involving them are normally done in a separate and highly controlled process on a large scale. The production of polyethylene from ethylene gas is a good example of this.

*Number and Type of Building Blocks Used in the Polymerization Process.*

In some cases, the polymerization may involve the use of a single building block that is caused to repeatedly link to itself and form long chains, as is the case of  $\epsilon$ -caprolactam to form nylon 6. This type of reaction is referred to as *addition* polymerization. In other situations, two building blocks are combined to form a polymer, such as the polymerization of hexamethylenediamine (HMDA) and adipic acid to form nylon 6/6. This type of reaction is called *condensation* polymerization. When liquid raw material constituents are used, it may be possible to directly convert them to parts, but this may be prevented if other factors are involved.

*Environment in Which the Reaction Must Take Place.* In some situations, raw materials may react and polymerize readily when simply mixed together, such as epoxies. In others, unusual conditions of heat and pressure may be required to accomplish the polymerization. For example, high pressures and temperatures are required to produce polycarbonate. If unusual conditions are needed, then raw materials are converted in a separate, dedicated process that produces polymers in a basic form.

*Presence of Other Physical Agents to Achieve the Desired Results.* Most polymerization reactions require the presence of one or more catalysts. A *catalyst* is a compound or agent that promotes a reaction but that is not consumed by the reaction and is not normally an important constituent of the finished polymer. Because catalysts are often expensive, it often makes sense to use them within the confines of a specific manufacturing process so that they can be controlled and used again.

Once the base polymer is prepared, it may be ready for commercial use. In many cases, however, further work is required to enhance the physical properties offered by the polymer and to make it more forgiving during processing. Some commercial products are produced by blending polymers together and in many situations the base polymer is compounded with inorganic additives.

Inorganic additives such as glass fibers, pigments, heat stabilizers, UV stabilizers, and flame retardants are commonly incorporated into basic polymer formulations to impart special behavior. In most cases, these additives are compounded into the base polymer after the reaction and presented for processing after a separate operation is performed.

### 2.1.2 Direct vs. Indirect Conversion

The starting point for any process is thus defined by the nature and form of the raw materials available. The scope of the process can be described to explain how the transition from raw materials to finished product is made. The term *direct conversion* is applied to processes that start with raw materials and produce parts in one step. Extrusion and injection molding are examples of this type of process.

Other processes require that intermediate steps be performed to the raw materials on the path to finished parts. Examples of *indirect conversion* are thermoforming, which first requires the production of plastic sheet and injection blow molding, which requires the production of a preform before finished parts can be produced. Intermediate steps may be accomplished in-line as a defined portion of the process, or the raw materials may be the result of a separate process that was performed at a different location. The mechanisms of how these intermediates are produced will, of course, have an impact on process flexibility and economics.

### 2.1.3 Thermoplastics vs. Thermosets

Polymer reactions have another attribute that can have a significant effect on processing. Some polymers are delivered in a form in which the polymerization reaction is essentially complete. They are described by the broad term *thermoplastics*. Thermoplastic materials are converted to parts through the application of heat and force. They are normally delivered as solid materials (pellets, powders, or granules) and are melted by the process and cooled to solidification to produce their finished part form. Polymer materials that can be handled in this way are often referred to as being *melt processable*. One of the chief advantages of thermoplastics is that they can be remelted and used more than once (within limitations) by the processor.

Other materials are delivered in a form in which the polymerization reaction has not taken place or is only partially completed. In the case of polyurethanes, the isocyanate component is essentially unreacted and the raw material

is in liquid form. Phenolics and alkyd resins are delivered in solid form, but their level of crosslinking has only been partially completed. These materials are melted and then the crosslinking or polymerization is completed once they are in the shape of their finished parts. These type of materials are referred to as *thermosets*, and they normally cannot be remelted and reused.

#### 2.1.4 Heat Management

Heat is a necessary component of all plastics processing and its proper management is essential to producing quality parts. The type of material used is the most important factor in determining a heat-management scenario for a given process.

Thermoplastic materials by definition are melt processable. This implies that a sufficient amount of heat be added to the material to melt it in order to begin processing. Maintaining the material at a specific temperature during processing is important, because a material's *viscosity* or resistance to flow will vary with temperature. In some situations, it may be desirable to heat the material to a point where the polymer is almost wafer-thin. In others, the process may dictate that the material be kept at a temperature where it is melted but still has a degree of integrity so that it can be stretched or shaped.

Thermoset materials have special characteristics that have to be dealt with differently, because chemical reactions take place during processing. These reactions have to be properly staged because, in most cases, processing causes irreversible changes to take place. If the raw material components are liquids, they only have to be heated to a temperature that will promote a controlled and predictable reaction. In the cases where thermoset raw materials are in solid form, they must be heated to the point where they are malleable or can be moved according to the requirements of the process.

While heat has been added at the beginning of the process, it must then be removed once parts have been formed. The way heat is removed is critical because it affects the overall cycle of the process and influences the appearance and properties of finished parts. With thermoplastics, the amount of heat that must be removed will be somewhat less than the total heat introduced at the beginning of the process. The amount of heat removed with thermosets may have to be considerably more, because chemical reactions can produce additional heat during part formation that must be managed in the finished components.

### 3 BASIC PROCESSING MECHANICS

The path from raw material to molded component may be either straightforward or convoluted, but all plastics processing methods make use of fundamental physical forces to accomplish work. Every plastics process uses one of six basic physical strategies to produce parts.

As is indicated in Figure 2, all of the major plastics processes can be approached by understanding their basic strategies. By studying the strategy for a process, it is possible to gain an understanding of its origins, possibilities, and limitations.

### 3.1 Push Processes

Some processes produce parts by physically pushing liquid raw materials into a closed mold. Processes that use this strategy can be generally classified as injection-type processes, and they all involve pushing (inducing shear flow upon) the

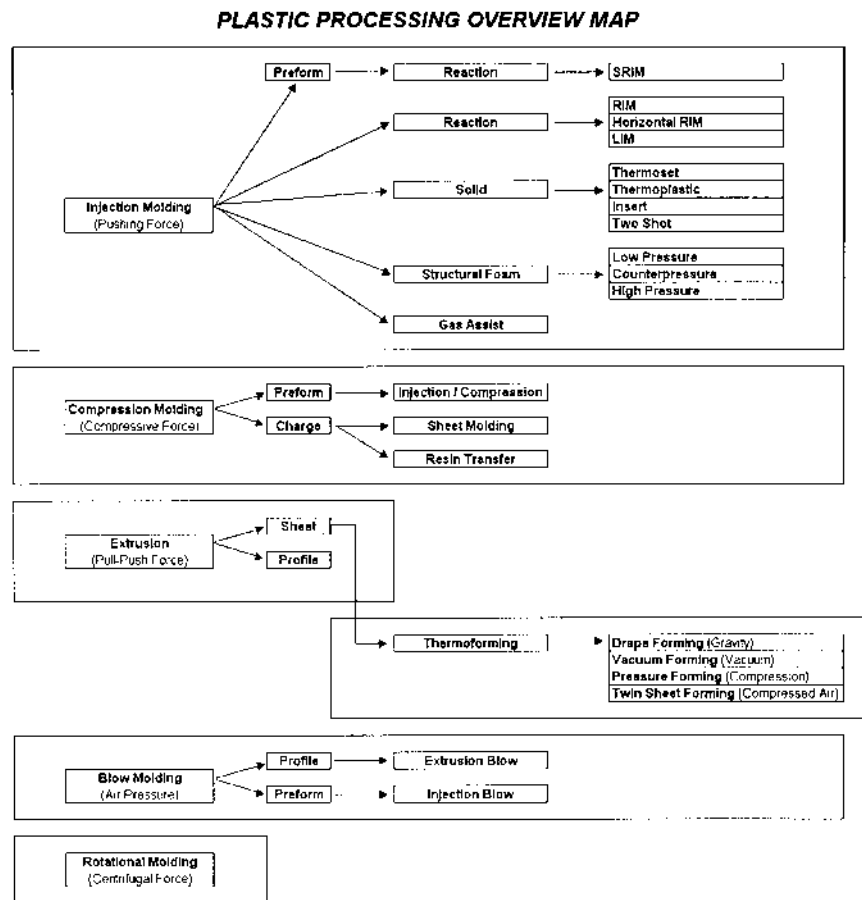

Fig. 2 Classification of plastics processes in terms of basic mechanical strategies.



material. The raw materials may be unreacted or partially polymerized constituents that are liquids at room temperature, as is the case for Reaction Injection Molding (RIM) or for Liquid Injection Molding (LIM). These processes generally work with thermosets and reactions occur inside the mold itself. The key to dealing with this type of process is to achieve very fast or turbulent flow so that the constituents will be intimately mingled to maximize the reaction rate and time to completion.

Working with thermosetting liquid materials has several advantages. Very large parts can be produced with these processes, and significant structure can be realized when glass fibers, mats, or other reinforcements are incorporated into the process. Moderate levels of part detail are routinely achieved, but the property combinations are dictated by the limited number of polymer types that lend themselves to processing in this way.

Other processes deal with thermoplastics that are melted to a liquid state and then pushed through channels into a closed mold. Thermoplastic injection molding and all of its derivative processes use this approach to produce parts. Melted thermoplastics are normally thicker or have a higher viscosity or resistance to flow than the liquid components found in the RIM or LIM processes and require higher pressures to process. Therefore, it is difficult if not impossible to push the materials fast enough to achieve turbulent flow conditions.

Melted thermoplastics have special characteristics, particularly because pushing force creates what is generally described as *Poiseuille Flow* in the material. When pushed, the molding material exhibits different levels of shear stress across the thickness of the part. Variations in stress levels can be controlled through design and processing, but are always a consideration in thermoplastic injection processes. Stress variations can affect the physical strength of the part, influence its ability to maintain shape and dictate its reaction when contacted by solvents or other chemicals.

Push processes using thermoplastics are broadly applied and highly versatile. It is possible to quickly produce highly complex shapes from very small to moderate size that have a high level of detail. At the same time, tooling for thermoplastic injection molding processes can be expensive because of the high level of operating pressure usually encountered.

### 3.2 Squeeze Processes

This type of process uses the force of compression between two mold halves to squeeze the material into the desired shape to produce finished parts. Two basic methods are used to introduce material into the mold: *charges* and *preforms*.

The first and most common approach is to open the mold and introduce a preweighed charge of solid material into the lower half of the mold. The mold is then closed and the material is squeezed into the shape of the finished part.

This is the method that is used to produce parts using the Sheet Molding Compound (SMC) process. The charged raw material is a precompounded wet solid mixture of thermosetting polyester resins and additives. Charged compression molding normally uses thermosets as raw materials, although thermoplastic compounds are beginning to gain acceptance for use in this process as well.

The second method of taking advantage of the compression approach is to load the mold with a preformed shape. The advantage of the preform is that more complex shapes can be produced and additional material can be introduced through injection or other means to encapsulate the preform and provide a unique finished product.

Compression processes can produce large parts, although the level of detail is necessarily limited because the force used can only cause limited movement of raw material. Because thermosets are commonly used, there is a limited range of property profiles that can be realized by these processes.

### 3.3 Pull-Push Processes

The most prevalent form of plastics processing (by volume of material converted) uses a pull-push strategy to move raw materials and convert them into finished shapes. The extrusion processes pull material through a heating mechanism and then push it through a die to produce two-dimensional profiles or sheets of material.

Extrusion processes are significant producers of primary products and also produce intermediates that can be subjected to further processing. The nature of the process dictates that thermoplastic raw materials or rubbers be used. Melted thermoplastics are viscous enough to be pushed through a die and still maintain their shape until they are cooled and completely solidified.

There are several advantages to extrusion that explain its popularity. While primarily restricted to thermoplastics and rubbers, a wide variety of polymers can be formulated to have the strength required to hold their shape after being pushed through a die. Tooling is cheap and application potential is plentiful.

There are still significant limitations to pull-push processing. Shapes produced by this strategy are necessarily limited to two-dimensional profiles, but many practical applications exist in this realm. The key advantage is that very long shapes can be extruded and cut to length to fit a variety of needs. Flat profiles are useful for siding and window treatments, while hollow profiles are extensively used for piping and ductwork. Meanwhile, complex profiles have found application in window components and seals, moldings, and seals of various types.

Extruded sheets are useful in their own right for glazing and architectural panels, but they also form the basic raw materials for an entire realm of secondary processes.

### 3.4 Forming Processes

Thermoforming is used to describe a family of processes that use sheet stock in the form of blanks as a starting point for producing shapes. In general, forming methods are described as indirect conversion, open-mold processes. They are extremely useful in producing large, simple shapes on inexpensive tools, particularly when overall volume requirements are low.

Sheet stock can be produced using variations of the physical mechanics used by other processes. Simple drape forming uses the force of gravity-induced creep to allow a preheated blank to form over an open male mold. Vacuum may be applied to either a male or female mold to improve the formability and improve detail. In an approach similar to other compressive processes, pressure forming squeezes heated material between two mold halves to produce a crisply finished shape. Finally, two sheets may be heated and formed outward against the walls of a closed mold to produce hollow shapes.

### 3.5 Blowing Processes

This type of process uses compressed air to displace and form melted material into shapes. The concept is generally described as blow molding. The application of the strategy works well in the production of hollow shapes, and works in much the same way as blowing up a balloon. Air pressure can be applied over a wide surface area and can be useful in making very large parts.

The use of air pressure to move material has certain advantages, but it is also subject to some specific limitations. Materials must be molten but still viscous and strong enough to respond to the air pressure in a controlled way. If the material is too thin, it will be unstable and difficult to control.

This restriction implies that only thermoplastic materials have the required physical characteristics to qualify for this type of processing. Resin manufacturers have developed special formulations that exhibit good *melt strength* and that are predictable in the melted state. Thermosets that are based on unreacted liquids or solids that do not have well-defined behavior during reactions do not have the stability required for blow molding.

Because the force of compressed air is relatively low when compared to the forces required to compress plastics or to push them into a closed mold, the amount of detail and definition that can be achieved is somewhat limited. At the same time, the application of air to produce a hollow shape also limits the possibilities with regard the overall complexity of shapes that can be produced.

### 3.6 Rotating Processes

The use of centrifugal force can also be used to effectively produce hollow shapes. Material, usually in fine granular or powdered form, is introduced into

a heated, hollow mold while it is rotating. The material is deposited on the walls of the mold and is built up to its ultimate wall thickness. This processing strategy is generally referred to as rotational molding.

As with blow molding, the process is capable of producing very large three-dimensional shapes such as those found in recreational equipment and agricultural tanks. Because rotational molding operates with open molds at essentially ambient pressure, tooling is economical and can be fabricated from sheet metal.

Still, there are limits to this strategy. There are a limited number of polymers that can be specially formulated so that they build up on the mold walls in the appropriate way. Cycle times are relatively long when compared to other processes. The level of detail and complexity that can be designed into rotationally molded parts is somewhat limited, although special techniques have been developed that are substantially expanding the horizons of this type of processing.

## 4 SELECTING A PROCESS

The decision to produce a part from a particular process is the result of several factors. First, the way a component is designed within the context of the overall product or subassembly sets the stage for its possibilities and limitations. Next, the chosen process must be capable of producing the part to the desired geometry and meet its defined performance requirements. Finally, the manufacturing economics for the scenario must be favorable (1).

### 4.1 Components in Context

The key to success with plastics applications has its foundations in product design. Once a product's form has been visualized, it must be reviewed and interpreted in terms of its component parts. Good, manufacturable component designs are those that are based on an understanding of the capabilities of both materials and conversion processes. Successful applications usually take advantage of some of the general benefits of using plastic materials:

- The ability to consolidate parts
- The ability to integrate, reduce, or eliminate fasteners
- The ability to simplify or eliminate secondary operations

Workable solutions tend to be recognized and proliferated, because they lead to better product performance and economics. While many designs can be developed through imitation, unique and better solutions are normally the result of an in-depth understanding of the possibilities.

Because every potential plastics application is described by a unique set of circumstances, the degree of difficulty associated with process selection for a given component can range from intuitively obvious to very complex. Situations that involve radical product redesign, short product life cycles, a limited tooling budget, or uncertain volume forecasts tend to make process selection more difficult, because historical precedent may have little or no relevance to the decision at hand.

The most effective way to make component process-selection decisions is to work within a framework that includes three basic elements: (1) a well-defined statement of the problem; (2) a good understanding of the candidate processes; and (3) a logical set of priorities for decision making.

The way to take advantage of an in-depth knowledge of processes is to review complete products or subassemblies and consider how individual parts should be defined within them. In other words, process selection should ideally be integrated into a product's concept development phase so that maximum manufacturing flexibility is preserved from the outset. Components can thus be defined within the product-as-a-system framework to uncover unique benefits that may be associated with a particular process (2).

## 4.2 Process Capabilities

At the individual component level, each basic process type has a range of specific strengths and limitations that are derived from its fundamental strategy. Each process type offers a unique profile of possibilities that makes it well suited for particular types of applications. There are, however, some areas of overlap, and many situations exist where more than one process can do a given job.

A review of the fundamental process possibilities will help explain why certain parts are produced using one strategy and not another. When application requirements can be met by one or more competing processes, it is usually simple economics that dictate the winner.

The capabilities of processes can be generally described by reviewing four basic characteristics:

1. *Part size.* There are normally size limitations that are dictated by the materials and the fundamental mechanics of a processing strategy. When a process is used to produce parts outside of its acceptable part size range, the quality of the parts or the economics will suffer.
2. *Part shape.* Tooling considerations and the approach to moving material will determine what kind of shapes can be produced. Shapes can be defined by their *dimensionality*. Pull/push processes, for example, can usually only produce two-dimensional shapes with a constant cross section because material is pushed through a die. Push processes

- use closed molds and can produce complex shapes that approach three dimensions if slides or other types of mold action are employed. Processes that use compressed air or centrifugal force can produce hollow shapes that are truly three dimensional.
3. *Part complexity.* Again, the processing strategy places limitations on just how much complexity can be produced in parts. The shapes produced using forming, compressed air or centrifugal force are limited in their ability to reproduce surface detail and to incorporate fine features such as standing ribs or bosses. Higher pressures used by compression and push processes make it possible to produce parts with higher levels of detail.
  4. *Material flexibility.* Part of the utility of a processing strategy involves the range of raw materials that can be successfully and economically used. For example, the success of push-type processes is due at least in some measure to the broad array of materials that can take advantage of this strategy.

One good way to create a summary of the capabilities of different process types is to use radar plots. Figure 3 shows each of the six process types and allows for ready comparison.

Push processes lend themselves to the production of parts that are small-to-moderately sized and that have a high degree of detail and complexity. They are also prime contenders in situations where exacting performance requirements can be obtained by using different raw materials. Squeeze processes cannot easily produce a high level of complexity or detail, but they can be used to produce large parts that are very strong and that have excellent surface appearance.

Pull/push processes are best employed in the production of profiles or sheet stock. They take advantage of situations that involve the production of parts that are cut-to-length and that can be produced continuously. Forming processes, which use sheet as a raw material, are useful in producing simple shapes under low pressure. Either very large parts or a large number of smaller parts can be produced using a forming strategy.

Processes that use compressed air can be applied to producing large, hollow complex shapes with a moderate level of detail. Similar hollow shapes can be produced using centrifugal force, although larger parts are possible by this approach. Material availability is limited, as is the amount of complexity that can be incorporated.

### 4.3 Part Economics

When more than one process can produce a part, the ultimate choice is normally driven by finished part economics. Ultimately, part costs are viewed as the cal-

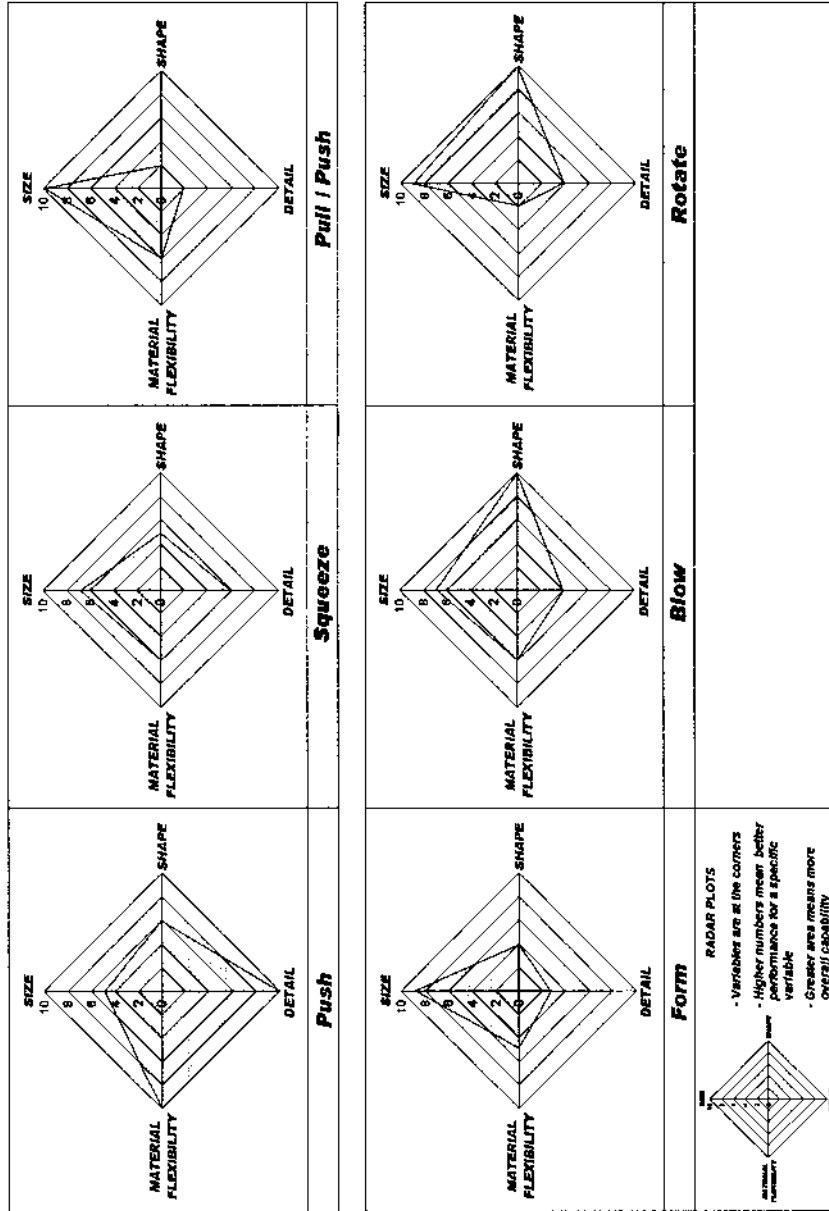

FIG. 3 A comparison of process capabilities. Comparison of basic process capabilities using radar plots. Variables are rated from 1 to 10. Higher numbers and greater surface area are indications of higher inherent process capability.

culated variable cost per unit. Variable costs, however, do not always reflect the total situation because capital investments in tooling must also be made to put the part into production.

There is normally an inverse relationship between part cost and tooling cost. Logically, a larger investment in tooling will generate benefits such as faster cycles or production rates, higher production capacity, or the ability to produce more complex parts. These factors will tend to drive individual part costs down.

Uncertainty can color the process-selection decision, particularly because capital investment in tooling can represent substantial financial risk. For example, the decision may be made to produce soft tools for pressure forming for a new product where there is some question about volume projections. Hard tooling for injection molding would result in lower part costs, but the up-front investment in soft tooling is much smaller and defrays product risk until the uncertainty is removed.

#### 4.3.1 Capital Costs

Each process has its unique requirements for tooling, but the costs are generally related to the following factors: (1) part size or total projected area; (2) mold structural requirements; (3) materials of construction; (4) cooling management needs; and (5) complexity of the part's geometry.

Part size or projected area (in closed molds) dictates the overall size of the mold. Multiple cavity molds for small parts may require as much projected area as the single cavity footprint for a large part. The overall size influences the structural requirements for the mold, although the general structural needs are also determined by the operating pressures generated during processing.

Materials of mold construction are chosen based on their structural strength and durability. If only a few parts are required, as is normally the case for prototype molds, it is usually possible to use cheaper materials of construction for the mold.

These factors in combination with the overall structural requirements dictate common choices of mold materials for different processes. For example, high-grade tool steel is normally required for injection molding because of high pressures, while rotational molding tools can normally be built by fabricating metal plate. The requirements for low pressure forming molds can even be simpler—wood or nickel-coated epoxy will often suffice.

Some processes require cooling water for production molds, and the need for cooling lines or flooding jackets can increase the tooling cost. The combination of cooling lines and cavity replication represent the majority of the labor required to produce a mold. Large or complex parts require a substantial effort in machining for basic cavity replication. The presence of fine details normally



implies the use of electrodischarge machining (EDM) to produce with accuracy. More complexity translates into higher cost.

#### 4.3.2 Variable Costs

Variable or per-unit part-cost determinations require careful analysis and are influenced by several factors:

*Raw Material Cost.* The choice of material has a significant impact on the overall part cost. The cost of plastic resins varies widely and prices are related to physical property performance. Under normal circumstances, parts should be produced from the material that best meets application requirements at the lowest cost.

Finding the most cost-effective material is not always a simple task. The properties of different materials often overlap, creating many situations in which more than one material will perform well in the part. In some situations, using less of a higher cost material may be more cost-effective than using more of a lower performing one. At the same time, one of two similar materials may be easier to process than the other.

Because plastics are sold by weight, it is important to view part economics in terms of volume. A kilogram or pound of a material with a low density or specific gravity will produce more parts than an equal weight of a heavier one.

*Processing Costs.* Each process has an inherent variable cost structure. Considerations in this area include machine costs, energy costs, labor costs, and the costs associated with auxiliary equipment that may be needed to successfully perform processing. There may be appreciable setup charges in some situations. In general, larger parts require larger equipment that costs more on a per hour basis.

*Cycle Time.* How quickly parts can be produced is an important consideration. The speed at which thermoplastics can be safely molded is related to the thickness of the part, which determines how rapidly the part will cool and be safe to handle without deformation. Thermoset cycles are also determined by the rate of reaction and how quickly parts can develop the required green strength.

One useful technique for decreasing the effective cycle time for most processes is to build molds that are capable of producing multiple parts per cycle. For example, a part running on a 60-second cycle in a single cavity mold will produce 60 parts per hour. If a 16-cavity mold is deployed, on the order of 960 parts can be produced in an hour. Multiple cavities will raise tooling costs, but may have the effect of dramatically lowering the processing costs associated with each part.

*Secondary Operations Costs.* In some cases, raw molded parts may require labor to prepare them for coating or for ultimate sale. The need may be

simple, such as manually degating parts as they come out of the mold. On the other hand, raw parts may require substantial hand or machine trimming, sanding, or surface repair to allow them to be coated or to elevate them to a saleable condition.

## 5 COATING CONSIDERATIONS

Because the coating of raw molded parts can represent a substantial cost, the process-selection decision must incorporate the impact of this operation into the overall scenario. In some cases, it may be possible to produce precolored or color-matched parts and avoid the need for secondary operations altogether. In other situations, coatings may be necessary so that the part will meet its defined requirements.

The chosen material and process combination will have a significant impact on the coating process that is applied to the raw molded part. The material will influence the type of coating used, while the process will dictate what kind and how much surface preparation is required to achieve the desired results.

### 5.1 Materials

The material used to produce the part dictates the nature of the substrate that must be coated. Material selection is often entwined in the process-selection decision because not all materials can be used with every process. The ultimate decision may be material-driven, process-driven, or it may represent a compromise based on a variety of factors. In any case, the resulting material substrate and its own particular characteristics must be dealt with in terms of coatings performance.

Important decisions must be made based on the substrate material, such as finding the coating material and method that best addresses factors like surface adhesion, appearance, durability, surface properties, and solvent migration. A detailed description of this selection process is covered elsewhere in this text.

### 5.2 Surface Appearance

The selected process will produce a raw molded part that may or may not require surface preparation prior to coating. The surface finish may be limited by the inherent capabilities of the process. In general, higher pressure processes can produce better surface definition than processes that operate at low pressures. Push and squeeze type processes can often produce excellent surface definition and are capable of generating Class A surfaces or detailed grains out of the mold.

Blow and rotating type processes operate at lower pressures, but can still achieve a good degree of surface definition. These processes can generate many

standard surface grains and hold them well in moderately complex shapes. Matte or low-gloss surfaces can also be reproduced and held reasonably well.

Pull/push and forming type processes are generally more limited. Extruded profiles cannot be expected to produce a Class A surface or to hold a grain. Extruded sheet can be produced with a smooth surface or can be embossed to achieve a good grain. If the sheet is to be formed, then the problem becomes more difficult. The challenge with forming is to hold the surface or grain consistently as the sheet is stretched. Here, part geometry and materials play an important role in defining what is possible in a specific situation.

Some material and process combinations are inherently limited in their ability to reproduce surfaces with fidelity. If the surface is less than perfect, then manual intervention is indicated. Blemishes may have to be filled and the entire surface may have to be sanded in order to achieve a level of appearance needed.

### 5.3 Stress Levels

By definition, the act of plastics processing implies that stresses will be generated in the material. While the subject of stress in plastic parts is complex and beyond the scope of this chapter, some generally useful statements can be made.

The act of producing a compatible interface between coating and substrate can disrupt the stress patterns that are present on the surface of the part and result in a lowering of the part's physical properties. Stress disruption or relief can also induce stress cracking in the part surface. The degree to which this becomes important depends in part upon the levels of molded-in stress that are generated during processing. These levels are dependent to a degree upon the inherent nature of the selected process but can be influenced by the specific processing conditions that are used to produce the part.

Further performance degradation can result from solvent migration into the wall of the part over time. The effects of solvents may not be immediately evident and can cause long-term failure of the part weeks or months after it has been put in service. Careful selection of solvents and cosolvents used with the coating can prevent unnecessary and costly field failures.

## 6 PROCESS PROFILES

This portion of the chapter will provide a summary of plastics processes that will act as a reference.

### 6.1 Push Processes

Processes that push material into a closed mold are widely employed. In total, push processes offer the most overall versatility for general part manufacturing.

### 6.1.1 Injection Molding

*Mechanics.* Injection molding represents a straightforward approach to material conversion. The primary materials used by the process are thermoplastics in the form of pellets, granules, or powder, but some partially reacted thermosets are also used as a medium. Figure 4 is a representation of the basic process schematic. Raw materials are heated through a combination of shear work (usually induced by the mechanical action of a reciprocating screw) and external heating to reduce their viscosities to a point that flow into the closed mold can be accomplished through the application of external pressure.

During the *filling* phase, material is forced into the mold cavity under high pressure until the part is filled. Because plastic materials expand when melted, they will begin to contract when they enter the relatively cooler environment of the mold. To compensate for this, additional material is pushed into the mold during the *packing* phase. The material is then allowed to cool and solidify

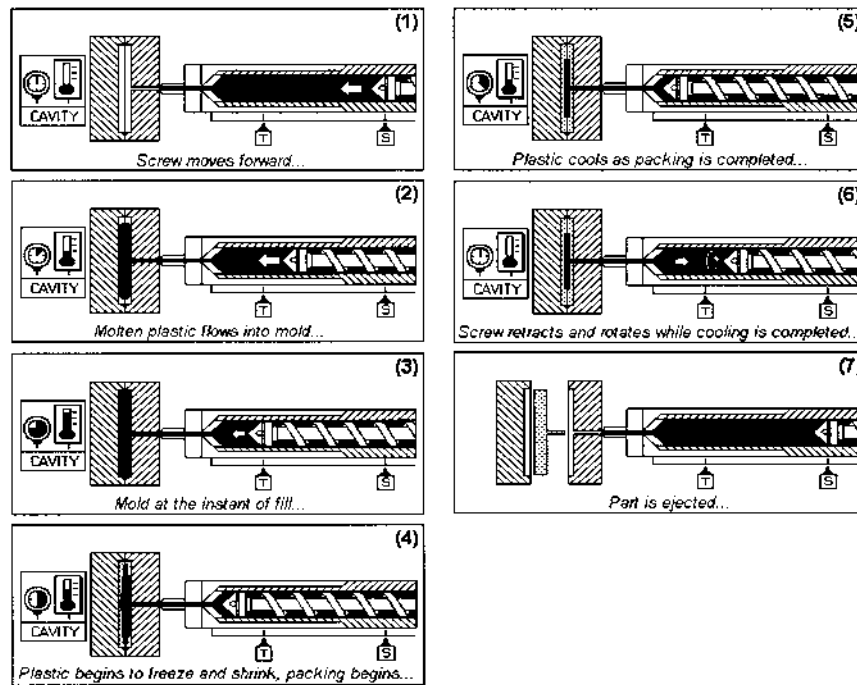

**FIG. 4** Injection molding cycle. Injection molding is a complex process that produces intricate parts inside a closed mold under high pressures. It is probably the most capable and versatile of all plastic processes.

during the *holding* phase. During injection, the mold is clamped together to offset the pressure of the material flowing into it. Most production molds incorporate temperature controls that manage the cooling and subsequent solidification of material once it is in the mold cavity. When the material has solidified, the mold can be opened and the part ejected or otherwise removed. The essence of injection molding, therefore, involves understanding the shear flow behavior of materials under varying conditions of temperature and pressure when melted, and being able to exercise precise control over these variables at any point in time.

These variables imply that there is an upper limit to how far a given material can flow under conditions created by injection molding, which sets practical ceilings for part size that can be obtained using conventional gating techniques. These material limitations can be successfully overcome through the use of hot runner systems, in which a reservoir of material is held at temperature in a manifold and injected into the cavity through multiple nozzles or bushings. In this sense, flow length is not a limiting factor because larger and larger parts could be theoretically manufactured by increasing the number of material entry points.

Pressure is the variable that dictates upper part-size limits in another sense. Clamping pressure must offset the pressure generated by material flow in order to keep the mold closed, and force is normally measured in tons per square inch of projected part surface area. The clamping force required is proportional to the amount of area projected by the part as it is configured in the mold, and size limitations are set by the clamping pressure ceilings on available equipment.

*Advantages.* Injection molding excels in the high-volume production of complex components. Very fast cycles on the order of several seconds are possible for thin-walled parts. The use of multiple cavities in the mold can boost the output geometrically. If slides, cams, or lifters are incorporated into the mold design, parts can be produced that approach fully developed three-dimensional shapes. The process is capable of holding tight tolerances in very small parts and can faithfully reproduce surfaces. Out-of-mold appearance is excellent, and clear or molded-in color is easily obtained through the proper material selection.

The process may be used to produce medium-to-large parts, within the limitations of material flow and available clamp tonnage of the molding machine. In general terms, the upper ceiling on size of parts is on the order of one square meter in the projected area. The resulting parts may be flexible (rubbers or elastomers) or may be very stiff if the selected materials incorporate glass fibers, carbon fibers, or other stiffening agents.

*Limitations.* Injection molding is constrained by the high pressures required for the process. Rapid delivery of the melt to the mold is a desirable goal in cycle-time management, but the speed at which this can be accomplished is

described by the *rheology* or flow behavior of the material in conjunction with other factors. Acceptable lower limits of stock temperatures for flow are described by glass transition temperature ( $T_g$ ) for amorphous thermoplastics and melt temperature for crystalline thermoplastics. Increasing the stock temperature of amorphous thermoplastics normally results in a decrease in viscosity that has a corresponding increase in flow, but care must be exercised in light of the possibility of material degradation due to excessive exposure to heat.

Injection pressure also adds heat to the material on its way to the mold in the form of shear or frictional heating. Excessive injection pressure can cause local burning in material or overall degradation. Pressure requirements are also a function of part and tool geometry. Large part volumes, thin walls, tortuous flow paths, and geometric complexity can add to the difficulty of delivering melt to the mold in an acceptable time frame.

In addition, part removal can only be achieved after the material has cooled inside the closed mold to a point that it has returned to a solid state. At the same time, restrictions imposed by the use of two mold halves limit geometries that do not correspond to the line of draw in the mold. While die-lock conditions can be avoided through the use of moveable cores, slides, or cams, these techniques add substantially to the already high tooling costs.

*Materials.* Nearly all thermoplastics can be injection molded and resin manufacturers tailor the rheology of their materials for maximum performance. Some thermosets can also take advantage of the process, if they are properly formulated for shear flow and if they are presented in a partially reacted state.

*Tooling.* Tooling is relatively expensive for injection molds. Production molds are normally machined and burned (electro-discharge machined) from tool steels (P20) and must be structured to withstand high pressures. Precision is required to incorporate cooling lines, ejector pins, and cavity pressure transducers or temperature monitoring sensors. The use of hot runner manifolds adds further complexity and cost, but may be justified because cold runners and their associated costs are eliminated in manufacturing.

Prototype molds, because of their low volume requirements, can often be produced from less expensive materials. Brass, aluminum, or mild steel may be acceptable for low volumes and will machine much more rapidly than hardened steel. It may be acceptable to prepare cavity inserts that can be incorporated into standard mold base assemblies.

Costs can also be managed by focusing efforts on cavity reproduction and avoiding some or all of the features that are necessary for high-volume production. It may be possible to produce a limited number of acceptable parts on a mold with no cooling lines or through the use of loose piece inserts in lieu of slides or lifters.

### 6.1.2 Structural Foam Molding

*Mechanics.* Structural Foam (SF) uses the same basic approach as injection molding for conveying the material to the mold when thermoplastics are the raw material. Thermosets can be induced to foam as well, and this approach normally uses equipment associated with the RIM process. The uniqueness of this process approach stems from the introduction of inert gases or reaction product gases that disperse into the resin inside of the closed mold. These gases have two major effects upon the part—an increase in stiffness and a reduction of the material's density or specific gravity.

The cycling mechanism is unique in that the molds are not totally packed out as they are in injection or RIM. Several methods are used to accomplish this, and some of them have been patented. The *short shot* approach allows for the blowing agent gas to assume the holding pressure function and disperse itself within the polymer inside the mold. In other methods, the mold is allowed to expand or excess material is allowed to move out of the mold to allow for foaming to take place.

There are several variations of the foam process. The most common thermoplastic version is referred to as low-pressure foam molding, which can produce very large low-stress structural parts on equipment with relatively low clamping force. As with hot runner manifold injection molding, the part-size potential can be increased through addition of a melt accumulating device and the incorporation of multiple nozzles. The vented molds used in this type of foam molding normally produce parts with a characteristic swirl pattern on the surface, which is the result of gases reaching the mold surface before the polymer can cool to form a continuous skin.

Other variants seek to address the surface appearance issue. Gas counter-pressure molding uses sealed molds to promote the formation of surface skins before venting to the atmosphere is allowed. Coinjection molding takes the approach of using two different injection systems—one provides a solid skin and the other the cellular core. High-pressure foam molding uses injection-type equipment and a moveable mold platen to allow for foam expansion while maintaining an injection quality surface on one side of the part. Finally, thermoset foam molding, because of the nature of its liquid components, tends to also exhibit improved surface appearance when compared to the low-pressure process.

*Advantages.* Structural foam is best applied in the low-to-medium volume manufacture of large, stiff, light parts. Because the overall hydraulic and hydrostatic pressure requirements are lower for SF than for injection molding, it is possible to produce very large parts from the process. Parts of moderate complexity that are on the order of three square meters in size can be manufac-

tured to acceptable tolerances. The presence of blowing agents gives the flexural modulus of the parts a boost, which adds to stiffness while reducing overall part weight because of the resulting density reduction.

The reduction in pressure requirements also leads to lower cost tooling and quick turnaround times for the development of molds. This makes SF an effective “bridge” process that can be used for lower-volume production or as an interim approach to production.

*Limitations.* The nature of the process puts general limits on the quality of the surface appearance that can be obtained on the molded parts. Some secondary operation may be involved to bring appearance parts up to their required level. Because the development of cell structure requires time, it also slows down the effective cycle time that can be achieved when compared to injection molding.

The behavior of the blowing agent sets some practical limits on the structural foam process. This problem manifests itself somewhat differently with different approaches. The first challenge is to prevent the blowing agent from reaching the surface of the part before a solid skin can be formed in order to get the quality of surface reproduction that can be routinely achieved with injection molding or RIM. The surface appearance of the part can be improved, but there is always an associated cost.

The presence of blowing agents increases stiffness, but will negatively effect the overall strength of the part. The second aspect of the blowing agent problem relates to achieving a uniform dispersion of closed-cell bubbles within the core, which will have a marked effect upon part structure and overall mechanical properties. The ability to do this is dependent upon part geometry. Complex wall section transitions and details at the end of the flow path can make it difficult for an even dispersion to occur.

Dispersion is also related to the ability to control part density, which makes it unwise to use the process for the production of small or thin-walled parts. There are practical limitations to the minimum wall thickness needed in order for cell structure to develop. The problem has two ramifications—the loss of the density reduction advantage in part weight, and the loss of rigid structure that is imparted by the cellular core. Current thin-wall thermoplastic systems are designed to a minimum thickness of 4 mm (0.157 in) for adequate cell structure development.

*Materials.* Like injection molding, most thermoplastics can be converted with the SF process. Some thermoplastics use specially formulated chemical blowing agents that react during processing. Nearly all materials can be foamed with variations of the foam process that use inert gases for blowing. Thermosets, particularly polyurethanes, are also suitable for the SF process and use gases formed during processing to develop cell structure.



*Tooling.* While some molds are developed from tooled steel, SF tools can often be built from machined aluminum, cast aluminum, or even nickel-coated epoxy. Tool material selection is usually driven by a prediction of the pressure ceilings, appearance requirements, tolerances, and part volumes needed for a given job.

### 6.1.3 Reaction Injection Molding

*Mechanics.* The RIM process can best be described as a variant of injection molding that uses thermoset systems normally consisting of two liquids that react inside the closed mold to form a solid part (Fig. 5). The two heated liquid streams are metered to precise ratios and placed in intimate contact under high pressure in a mix head. The liquid then enters the mold at a much lower pressure where chemical crosslinkings are completed and a solid part can be removed from the mold. The implication of component ratios is that a degree of property tailoring of the final part is achievable by the machine operator.

Glass fibers or flakes can be added to enhance part stiffness, in an approach referred as Reinforced RIM (RRIM). There is a practical ceiling to the effectiveness of this technology, set by the difficulty associated with keeping the glass evenly dispersed during the entire cycle. The idea behind the RRIM approach is similar in nature to the addition of reinforcing agents through compounding taken with thermoplastics.

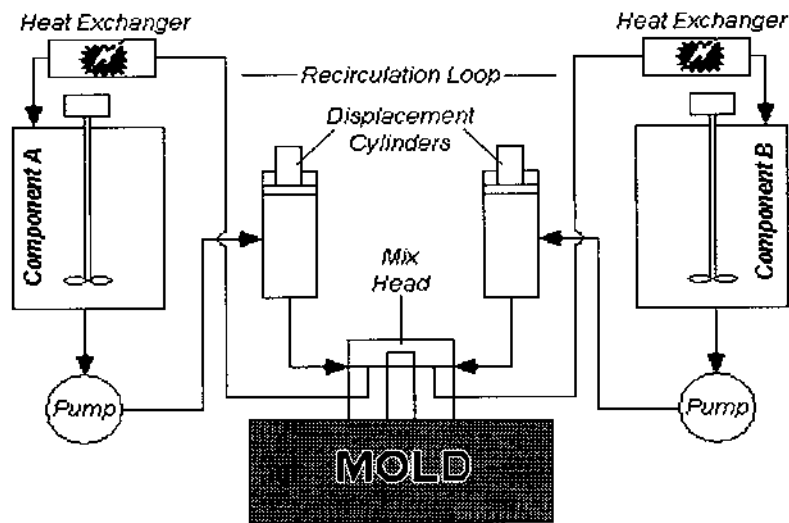

FIG. 5 The Reaction Injection Molding (RIM) process involves the turbulent mixing of two liquid components inside a closed mold to produce large, complex parts.

Structural RIM (SRIM) is a relatively new process that involves a combination of traditional RIM technology with the use of a preformed reinforcement that is placed in the mold prior to injection. The introduction of a reinforcing preform into the mold addresses the traditional stiffness limitations that are associated with unfilled or RRIM systems, and offers a significant structural improvement over the use of glass fiber or flake. The RIM material impregnates the preform and forms a skin around it, providing a composite part that can be then removed from the mold.

*Advantages.* The RIM process is a very effective way of producing very large, detailed parts at any volume level. This process can be used to produce large parts that are equal or larger than those produced using SF with the detail associated with injection molding. Parts may be flexible or highly structural, depending on the formulation and techniques used. The SRIM process is gaining favor as a viable alternative to metals in applications where high load bearing is required over extended periods of time.

Where flexible material formulations are used, it is often possible to avoid the costs associated with mold action and to negate the effect of undercuts by stripping the parts from the mold. In nearly all cases, raw materials used in the process lend themselves well to coating operations once parts have been removed from the mold.

*Limitations.* The use of RIM is chiefly constrained by the limited number of raw materials that can be used with the process. The process only makes sense if the required part performance can be matched up with the properties offered by urethane or (to a lesser extent) nylon chemistry. While small parts can be produced through the process, much better economics and processing consistency can usually be achieved by injection molding, especially when the higher tooling costs of that process can be amortized over high production volumes.

The RRIM process is limited by the problems associated with dispersing the glass evenly into all areas of the mold. Because of this, it may be difficult to develop adequate strength in key performance areas of the parts such as ribs and bosses. Small changes in processing conditions also open the door to significant part-to-part variation in physical performance.

The SRIM process offers unique capabilities, but it has special limitations that are a result of its indirect conversion from raw materials to molded parts:

1. *Impregnating the glass fiber preform.* Traditional RIM exploits the advantages of low cavity pressure, but low pressure is at odds with forcing a somewhat viscous liquid through a woven or random mat with some assurance that voids can be eliminated. This issue is being addressed through the development of new systems that have and hold lower viscosities to accommodate the impregnation process.

2. *Quick setup once impregnation is achieved.* There is a practical ceiling upon the rate at which material can be injected into the mold without displacing or damaging the preform. This implies that the reactive systems are required to have rapid and controllable gel formation that is markedly different from the way traditional RIM materials behave.

*Materials.* The RIM process is materials-limited. Formulations are overwhelmingly based on urethane chemistry, although significant efforts are underway to use other polymers such as nylon to form a workable raw material combination.

*Tooling.* The RIM process favors large components, so molds are usually built for one or two cavities. Because the operating pressures for RIM are relatively low, molds can be produced from a variety of lower-cost materials. Prototype molds are commonly produced from nickel-coated epoxy, while production molds may be built with electroformed nickel, machined aluminum, or mild steel. If glass fibers or flakes are used in the material formulation, special consideration must be given to avoid surface abrasion over the useful life of the mold. Mold cooling is important in production molds to maintain an economical cycle time, and the cost of routing cooling lines must be factored into the cost of the mold. Overall mold costs should still be significantly lower than for an injection molding tool for the same part.

## 6.2 Squeeze Processes

### 6.2.1 Compression Molding

*Mechanics.* The compression molding process has been in use for a long time and is similar in concept to the cold forming or cold heading process with metals. A weighted charge of raw material is placed inside the bottom half of a heated mold. The top half is then closed over the charged lower half under high pressure. The raw material undergoes cold flow and assumes the shape of the cavity.

*Advantages.* The strength of compression molding lies in its relative simplicity. Very large parts with a high degree of structural integrity can be produced with relatively good tolerances. The process can be optimized after limited experimentation to determine the ideal charge weight and mold temperatures. Structure is developed rather quickly because the raw materials are processed below their melting points, making for relatively fast cycles based on the size and thickness of the part to be molded.

*Limitations.* The straightforward nature of the process also limits the complexity of parts that can be produced by compression molding. There are

limits to how far raw materials will move under cold-flow conditions, making it difficult to deal with geometric complexities such as thin ribs, gussets, or bosses. Because the process is inherently based on line of draw, the shapes produced must avoid geometries that introduce undercuts or otherwise introduce the need for inserts or mold action.

*Materials.* Compression molding is primarily used with thermosetting plastics that crosslink under heat and pressure. Special compounds based on thermosetting polyester (SMC), phenolics, epoxies, and alkyls are commonly used. Care must be taken to insure material consistency, because this is the major source of variation in the process.

*Tooling.* The nature of the process dictates that structurally strong materials be used to construct molds. A high degree of polish is normally required to produce a good surface finish, and the surface hardness should be high because of the abrasive effects of inorganic additives and fillers that are commonly used in raw material formulations. Hardened tool steels are the usual materials of choice for mold construction.

### 6.2.2 Resin Transfer Molding

*Mechanics.* Resin transfer molding (RTM) is a hybrid process that involves elements of both push and squeeze processes. A preweighed raw material charge is heated in a pot (Fig. 6) inside a closed mold. A ram is used to push the material into the mold under high pressure where it flows and fills the cavity or cavities. The mold is then opened, the parts are removed and a new charge of material is introduced for the next cycle. If multiple parts are produced in the same cycle, they must be separated and the cull thrown away. Unlike compression molding, the raw material is being processed above its melting temperature and can therefore be expected to flow farther inside the mold.

*Advantages.* The RTM process was conceived to overcome some of the limitations of traditional compression molding. The use of liquid raw materials greatly enhances flow and allows for much more complex shapes to be produced. It also favors the production of smaller, more complex parts and allows for a multiple cavity strategy to be employed where appropriate. Encapsulation, particularly in electrical applications, is feasible and much easier to accomplish than with traditional compression techniques.

*Limitations.* The RTM process is still limited by its roots in compression molding. Cycles are hindered by the effort required to melt the raw materials. It is still difficult to produce components that do not meet line of draw criteria. Some of the more structural aspects of parts are limited because highly loaded raw material formulations are difficult to melt evenly and resist flow in any

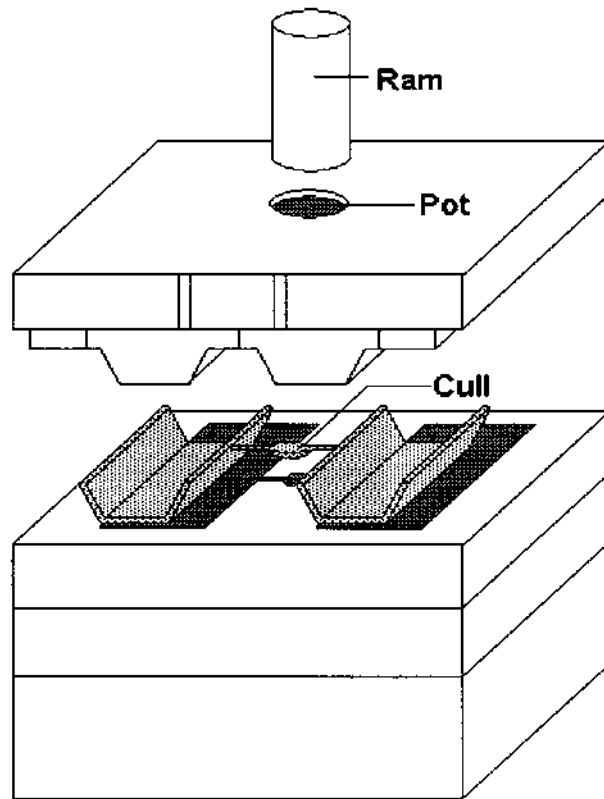

**FIG. 6** Resin transfer molding represents a hybrid approach to producing parts. It incorporates some elements of “push” processes with traditional compression molding.

state. If multiple parts are produced, the cull must be thrown away, because this process uses thermoset materials that cannot be reground and reused.

*Materials.* As with compression molding, the raw materials are thermosets. Commercial compounds are somewhat different than for straight compression molding, because they are formulated for flow and are processed above their melt temperatures. Care must be exercised with these “B-staged” materials to process them so that they do not excessively crosslink before filling the mold. This means that their time at temperature (or residence time) must be closely monitored so that they do not seize in the flow channels and bring production to a halt.

*Tooling.* The tools for RTM follow all of the rules for standard compression molding. Their cost is higher because consideration must be given for the construction of the pot in the core side of the mold. Multiple cavity layouts will also require more time for mold design and layout of the raw material feed system.

### 6.3 Pull/Push Processes

#### 6.3.1 Extrusion

*Mechanics.* Extrusion involves direct conversion of plastic raw material to finished shapes. Raw material is fed from a hopper and moved through a heated barrel by a screw. The plastic is melted from the friction generated by the screw as it is pulled forward and is kept at a constant temperature by auxiliary heater bands. Once at the appropriate temperature, the melted plastic is pushed out of the end of the barrel through a die into a long, continuous line of shaped plastic. The shape produced may be in the form of a sheet (Fig. 7), a film, a profile, or a filament. This line is drawn through a cooling bath, where it hardens and then is cut to length.

The use of a screw to melt or plasticate the material is similar in concept to the techniques used in push processes, but there are some fundamental differences. While push processes are aimed at intermittent movement of material into a closed mold, extrusion is intended to be used as a continuous process. This means that material throughput is much higher over an extended time period. Extrusion screws are designed to plasticate or melt large volumes of material quickly and continuously while imparting minimal physical stress or damage to the polymer structure of the plastic.

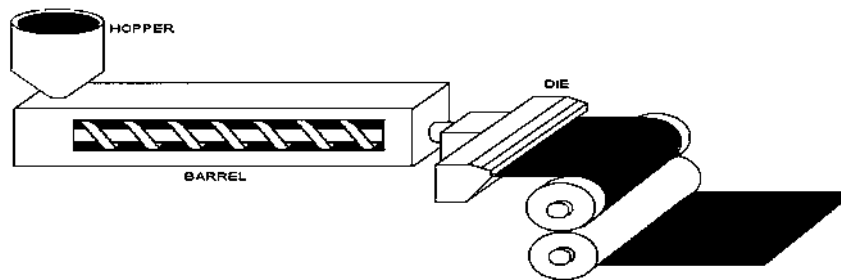

**FIG. 7** Sheet extrusion schematic. Melted thermoplastics are pushed through a broad die to form the profile of the sheet. Rolls are used to manage the takeoff. They may also be used to impart a texture to the sheet.

*Advantages.* Extrusion is the most practical and cost-effective process for producing shapes with a constant cross section. The cross sections that can be produced range from simple to moderately complex. Extrusion has shown that it is a highly adaptable process that can produce everything from bread or dry cleaning bags (films) to paintbrushes (filaments). It is appropriate for the production of sewer pipe, window moldings, and a variety of tubing types (profiles). Extrusion is widely used to add jacketing to electrical wires and cables. In addition, it can be used to convert thermoplastics to sheet form for architectural applications or for further conversion by forming processes. Extruded sheet can be given a surface texture by the incorporation of embossing rolls in the manufacturing line.

Tooling cost is generally low for extrusion, because it uses dies rather than molds for production. A broad range of thermoplastic materials can be used to produce extruded products.

*Limitations.* Extrusion is limited to the production of shapes with a constant cross section. Because relatively low pressures are involved, it is difficult if not impossible to produce a “Class A” surface with the process. While the capital equipment requirements and costs for general extrusion are low, specialized dedicated lines for producing film or sheet can be rather expensive.

*Materials.* Most thermoplastics can be formulated for extrusion. These special formulations are developed to have good melt strength so that they will hold up while being pushed through the die opening. Special considerations are also given to consistency and to managing the dimensional control of the materials during processing.

*Tooling.* Extrusion uses dies, which are normally constructed of hardened steel. Special care and consideration must be given to die design to insure dimensional control and repeatability required from continuous use. Costs for dies are low when compared to the high-pressure molds used in injection or compression molding.

#### **6.4 Forming Processes**

*Mechanics.* Plastic forming processes are a good example of indirect conversion of parts, because they require that plastic materials be first converted into sheet stock before they can be used. The creation of sheet can be done in-line, but it is more common for the sheet to be supplied as pre-cut blanks. The sheet is placed in a clamped frame and heated to just below its melting point and then moved onto or into a mold for forming. Single molds may be used in a purely batch configuration, or several molds may be arranged in a shuttle-type operation to produce a semicontinuous process.

There are several variation on the theme of forming, some of which are illustrated in Figure 8.

**SIMPLE DRAPE FORMING.** Drape forming, as the name implies, involves moving the sheet over a male mold half. The mold is pushed upward into the clamped sheet, which assumes the shape of the mold. It is common practice to apply a vacuum to the mold to improve the definition of the part that is produced.

**PURE VACUUM FORMING.** The term *vacuum forming* can be applied to drape forming as well, but in this case it is used to indicate the use of a female mold half. The clamped sheet is moved into place, secured, and then a vacuum is applied to the mold. The vacuum is particularly useful in this case, because the blank must be drawn into corners and deep pockets, and reproduce other features that are difficult or impossible to replicate with the force of gravity alone.

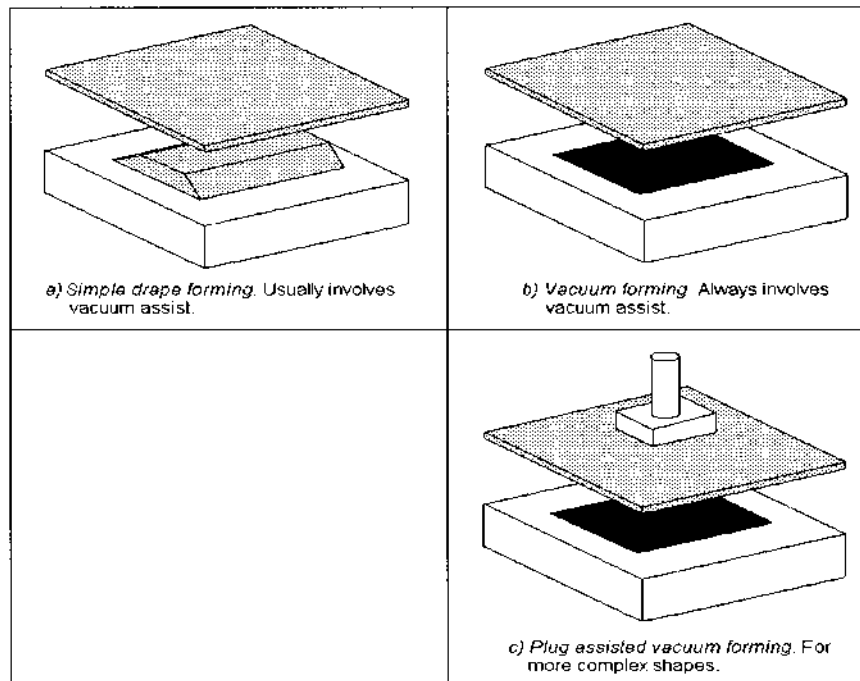

**FIG. 8** Variations of Forming. Forming has several variations that are based on the requirements imposed by the shape that needs to be produced.



**PLUG-ASSISTED VACUUM FORMING.** Another variation makes it possible to create more complex shapes than are afforded by simple forming alone. A mechanically driven plug is pushed into the sheet from above at the appropriate time to improve part definition and overcome the limitations imposed by gravity and to improve draw.

**TWIN SHEET THERMOFORMING.** This variation uses two mold halves (usually both female) to produce a three-dimensional part from two individual sheets. The two sheets are heated and introduced simultaneously between the mold halves, which are then closed around the blanks. A vacuum is applied to both mold halves and the perimeter is compressed. The resulting shape is then removed from the mold. The surfaces of the two sheets are fused together around the perimeter of a three-dimensional part, which can then be trimmed into its final geometry.

**PRESSURE FORMING.** This variation uses elements of “squeeze” processes. A closed mold consisting of a core and a cavity half is constructed. A clamped, preheated sheet is moved into place between the mold halves that are then closed around it. A vacuum may be applied to the mold to improve definition. The resulting parts are removed from the mold and removed from the blanks by a secondary trimming operation. The amount of detail that can be achieved in the parts is limited (as with “squeeze” processes) because the plastic material is always below its true melting point and this limits how far it can be moved during processing.

*Advantages.* The chief advantage of forming is that the cost of molds is low when compared to alternative processes. This makes the processes ideal for producing new products when the initial volume requirements are low or if the success of the product is uncertain. In general, forming lends itself to the production of large, simple parts where volume requirements are relatively low. This does not mean, however, that the process cannot be applied to high-volume situations—many food packaging applications are produced using high-speed forming operations.

*Limitations.* Forming’s appeal is somewhat limited by its use of gravity and low overall operating pressures. The parts that can be successfully produced are limited both in terms of surface definition and complexity. The nature of the processes dictate that material must be stretched to accommodate the shape of the mold. A necessary by-product of this strategy is that the parts will be thin in areas where the most stretching occurs. This makes producing a deep-drawn part with constant wall thickness particularly difficult to achieve. If grained sheet is used, it may be difficult to hold the grain in corners and areas of draw.

Another striking limitation is that parts must be trimmed from blanks after forming. This can create a process cost scenario that is prohibitive when the cost of higher-value sheet stock is combined with equipment, shuttle mold sys-

tems, fixtures, and either labor or equipment for secondary operations. It is a good idea to always review the system economics and not just the mold cost when considering forming as a production alternative.

*Materials.* Many thermoplastics, particularly the commodity resins, are well suited to forming and to its precursor process—extrusion. As with extrusion, grades are formulated to give the material good melt strength so that the sheet will hold up under gravity as it is moved from the oven to the mold.

*Tooling.* Forming operates primarily under the force of gravity and low-pressure vacuum, so structural requirements for molds are minimal. Because the plastic is kept below its melting point, cooling requirements are also minimal or nonexistent. Wood is a commonly used material of construction for forming, while higher performance molds can be constructed from nickel-coated epoxy or from electroformed nickel shells.

## 6.5 Blowing Processes

Commercial blowing processes come in two basic variations: extrusion blow molding (EBM) and injection blow molding (IBM).

### 6.5.1 Extrusion Blow Molding Mechanics

The EBM process is a unique method of converting thermoplastics into hollow complex shapes (Fig. 9). Thermoplastic pellets are loaded into a hopper, and then reduced to melt through a combination of shear and external heating as in injection molding. A hollow tube of material called a *parison* is extruded (dropped) vertically between two open halves of a mold. When the parison

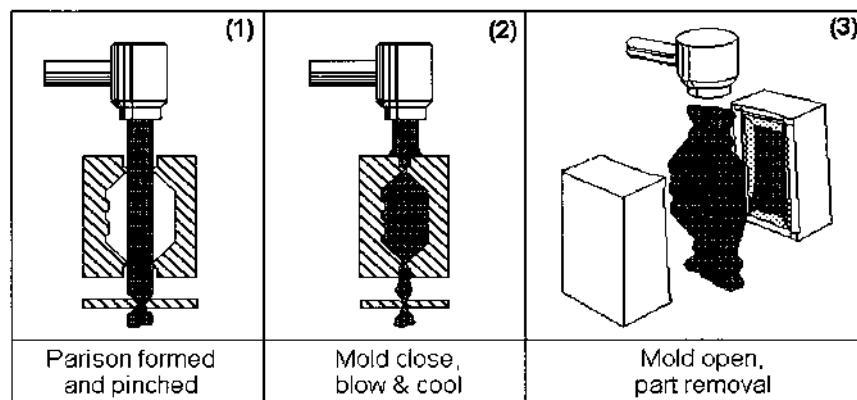

FIG. 9 Extrusion Blow Molding (EBM).

reaches the desired length, it is closed or pinched by mechanical means (pre-closures). In many cases, compressed air is applied at this point to partially inflate the parison and help it retain its shape. Once the two mold halves have been closed around the parison, it is further inflated to cause the thermoplastic material to conform to the mold surfaces. The material begins to cool as it contacts the mold and resolidifies. At this point, the mold halves are opened and the part is stripped off. Although extrusion blow molding uses shear flow in the formation of the parison, the mechanics of part formation rely on planar extension (similar to forming) to stretch the material into the shape of the finished part.

The essence of blow molding is:

1. *Making a parison of the proper size and strength.* The parison formation activity is controlled by the size of the head tooling, which controls the outer diameter. The parison, once sized, must retain its shape until the mold can close and the part can be inflated. Unlike injection molding, where good shear flow is prized, blow molding requires materials that have strong elasticity or melt strength to hold their shape.
2. *Managing parison movement during inflation.* As with forming, even materials that have excellent elastic behavior when melted have limitations as to how far they can stretch before they thin to the point of rupture. In this regard, there are some geometric shapes that cannot be blow molded because they demand more stretching than the material can withstand.

### 6.5.2 Injection Blow Molding Mechanics

The IBM process is another “hybrid” process that incorporates elements from both blow molding and injection molding. The primary difference between IBM and EBM is in the formation of the parison, which is produced through an injection molding step. Extruded parisons are limited by the realities of gravity and extrusion, and the ability to precisely control wall thickness can limit the dimensional control of the finished plastic part. Injection molding allows for more control in these areas and can offer cycle time advantages through the use of multicavity molds.

The control offered by IBM makes it particularly well suited to dealing with the problems presented by bottles or similar threaded containers. As Figure 10 shows, the process normally involves three steps and is typically organized around a rotary operation. The mold is set at the first location and aligned with core pins or rods that will define the inner diameter of the parison. The molten plastic is injected under low pressure around the core rods and simultaneously fills part detail areas such as threaded closures. The material is allowed to cool slightly and is opened and rotated to the second station.

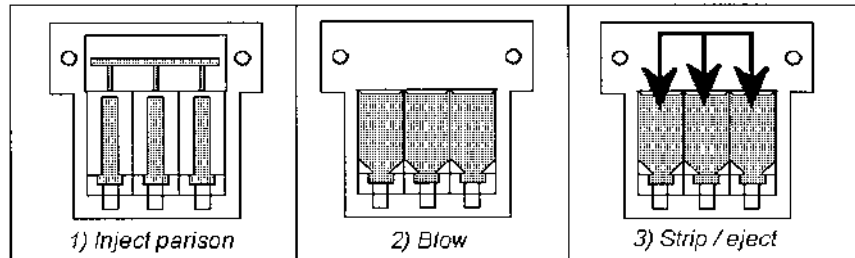

**FIG. 10** Injection Blow Molding (IBM). The process has three primary steps and is usually laid out in a rotary shuttle to accomplish them.

At the second station, air is injected into the core rods and the parison is blown outward to the mold walls. As with EBM, the parison makes contact with the colder walls of the mold and forms its final part shape. At this point, the mold is opened and the parts are then moved to the third station on the core rods where they are stripped off.

*Advantages.* Blow molding is an extremely versatile process that can be used to produce moderately complex hollow-shaped parts that are truly three dimensional in shape. Small, hollow parts can be produced with great precision quickly using the injection molding process, while large, complex parts can be manufactured by EBM.

*Limitations.* Because the operating pressures used in blow molding are relatively low, it is difficult to achieve Class "A" surfaces out of the mold, particularly with EBM. Because the process is, in effect, a one-wall process (like forming processes), control of wall thickness can be a problem, particularly in areas where extensive stretching of the parison is required. Injection blow molding addresses this limitation to a degree, but at the cost of overall part size because shear flow is required to form the parison in the first place.

*Materials.* A wide array of thermoplastic materials can be blow molded. As with forming processes, specific grades are formulated for high melt strength to give the parison the ability to hold its shape while it is being blown against the cavity walls.

*Tooling.* Blow molds are subjected to relatively low operating pressures but can be subjected to locally severe stresses in key areas such as pinch-offs. Production molds are usually produced from cast or machined aluminum. Copper-beryllium is sometimes used for the complete mold or supplied for inserts in high-wear areas. Tool steels may be called for with IBM.

## 6.6 Rotating Processes

The use of centrifugal force gives rise to a novel way of producing plastic parts.

### 6.6.1 Rotational Molding

*Mechanics.* Rotational molding is a unique process that can produce large parts of moderate complexity with little or no molded-in stresses. The process is organized into three basic steps that are repeated in each cycle: Heating, cooling, and removal/charging. Most of the work is accomplished during the heating step, where the mold rotates in two axes inside an oven. The heat from the oven melts a premeasured amount of material, which coats the walls of the mold as it rotates about both the horizontal and the vertical axes (Fig. 11). This rotation allows all of the mold surface to be coated by the charge of melted material.

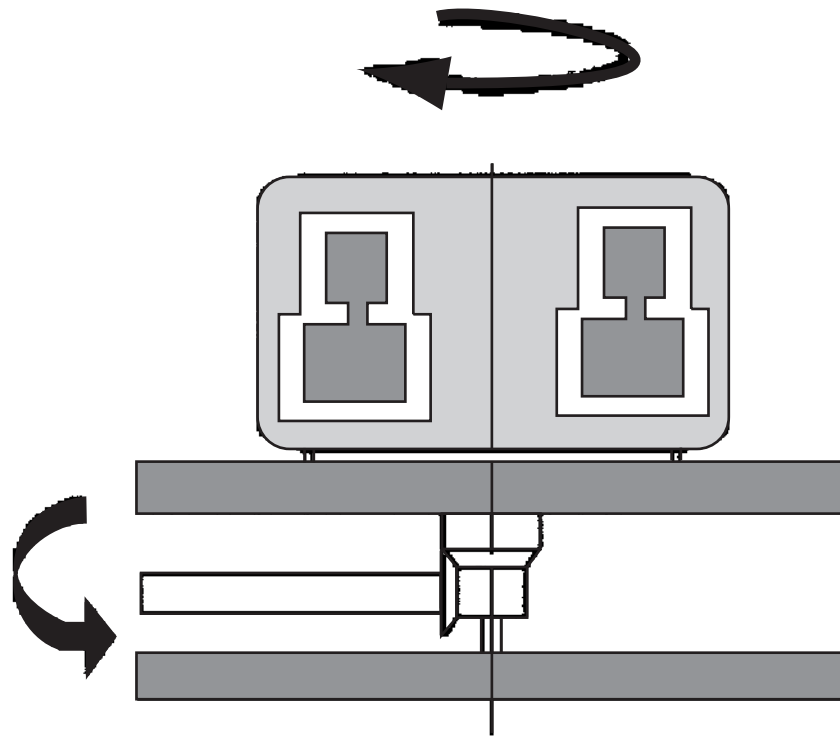

FIG. 11 Rotational Molding. The machine rotates the mold in two axes, allowing the melted plastic to coat the walls of the mold evenly.

Rotation continues as the mold is removed from the oven and into a cooling chamber during the second step. Cooling may be accomplished by air alone or by a mixture of air and water. The cooling step is terminated as soon as the plastic shape has hardened and has enough structure to be removed from the mold.

In the third step, the mold is removed from the cooling chamber and indexed to a part removal and charging station. The rotation is brought to a halt and the molded part or parts are removed. A new charge of raw material is introduced into the mold, which is then closed and the cycle begins anew.

*Advantages.* Rotational molding can be a very effective choice for producing large three-dimensional parts that can have good surface detail (if the mold surface quality is good). Some of the larger machines have a swing on the order of six meters, which makes it possible to produce parts like boat hulls or dump truck beds in a single cycle. Parts normally are anisotropic and have low molded-in stress. Material will accumulate in sharp geometric features such as part corners, which do not suffer from thinning as they do in forming or blowing processes. Tooling cost is relatively low for large parts, particularly when compared to higher-pressure push or squeeze processes.

*Limitations.* The advantages brought about by the use of centrifugal force also introduce some limitations. First, wall-thickness control is difficult to maintain with precision. Special design considerations and processing techniques can be employed to selectively thicken walls or to maintain a consistent nominal thickness throughout the product. Although corners will not experience thinning as with forming or blowing processes, they still can produce surface defects if not radiused generously.

Second, special considerations must be given to the design of flat areas to prevent bowing in the hollow shapes that are produced. Third, development of ribs or details off the surface can be problematical and can cause surface blemishes.

Finally, cycle time and handling considerations can limit the ability of rotating processes to compete to higher-volume-oriented push processes for many small components. The degree of tuning required for each individual design and mold can hamper the effectiveness of the process in the general realm of high-volume production.

*Materials.* Rotational molding is restricted to the use of thermoplastics that are specially formulated to work well with the process. The normal materials of choice are primarily olefins (polyethylene or polypropylene), although PVC, polycarbonate and nylons are also used.

*Tooling.* Tooling costs for rotational molding are relatively low because the structural demands produced by the rotating action are not particularly de-

manding when compared to other processes. The most popular material used for molds is cast aluminum, which can produce shapes of moderate complexity with good surface detail. Casting also has the advantage of quick and easy repeatability if multiple molds are required. Machined aluminum or mild steel is often used for inserts, pull pins, or for complete molds where heavy duty or exceptional surface quality is desired. Electroformed nickel and fabricated sheet metal are also used for prototyping, low-volume, or light-duty applications.

**REFERENCES**

1. S Stretch and S Crosby. A comparison of four closed-mold processes for the manufacture of large plastic parts. SPI Structural Plastics Symposium, Philadelphia, 1988.
2. S Stretch. Product effectiveness with structural plastics: the challenge of the 1990s. SPI Structural Plastics Symposium, San Diego, 1989.





# 3

## Formulating Plastics for Paint Adhesion

**Dominic A. Berta**

Basell Polyolefins, Elkton, Maryland, U.S.A.

### 1 INTRODUCTION

The focus of this chapter is on formulating plastics that are difficult to paint, such as polyolefins. The fact that polyolefins are nonpolar separates them from the plastics that are considered easy to paint or obtain good paint adhesion, such as, reaction injection molding (RIM), polyesters, or urethanes, which involve primary, strong chemical bonds that are more or less easily achievable, and more or less very durable. The real challenge in formulating plastics for paint adhesion or paintability is to be able to paint polyolefins. We are not going to undertake in this chapter what is perhaps the greater challenge of painting highly crystalline plastic polyolefins, such as polyethylene or polypropylene (PP), but the more practical and realistic challenge of formulating thermoplastic polyolefins (TPOs) that will be “directly paintable.” In this context, directly paintable is taken to mean that the TPO is able to accept a paint that is normally used for plastics and not specially formulated for adhesion to polyolefins. By their very nature, TPOs have a sufficient amount of amorphous material to allow for significant diffusion and solvation of the paint solution into the interior of the TPO to create a sufficient opportunity for bonds to form. If one considers the industrial or commercial importance of plastics selected for formulating for paint applications, thermoplastic polyolefins are probably a good choice, because the overall aspects of painting for appearance are most appreciated; and they are used to a large extent in vehicles by automotive manufactures. This use continues to rise for both interior and exterior applications (1).

From here on out, I will use the terms *polyolefin* or *TPO* to mean a thermoplastic polyolefin that is a blend (mechanical or so-called reactive types) of a plastic phase, primarily polypropylene, and an amorphous or elastomeric phase, consisting of truly ethylene-propylene copolymers or copolymers of ethylene with other  $\alpha$ -olefins, such as butene or hexene. Considerations that must be addressed from both a commercial or practical point of view, as well as a theoretical or scientific point of view follow.

The formulations described in the following sections of this chapter are directed toward automotive applications, where not just paint adhesion but durability are extremely important property considerations (along with property maintenance for long times under various environmental exposures and conditions). However, these same formulations can also be considered, with perhaps some minor adjustments, for applications such as film, where printing or coating may be desired, or fiber, where adherence of dyes would be desired.

The market for TPOs continues to expand worldwide with the largest applications being in automotive. The consumption for PP based plastics, for example, is estimated to be in the range of from about 40 to 50 lbs per vehicle in North America (1). For vehicle fascias, in particular, the motivation to increase the usage is for several reasons: (1) cost, (2) low density, (3) processability, and (4) recyclability. These factors are in comparable to other types of materials. TPOs represent an overall very positive cost/performance balance. For the most part, this usage for TPO fascias is concentrated on painted parts, but painting is extremely expensive. The cost of painting has been estimated to range from 45 to 70% of the total cost of the fascia. It is highly unlikely that any other method (such as molded-in color or color laminates) but painting will give a good enough match to the appearance, color, gloss, and all the immeasurable quantities that the human eye is able to discern or discriminate.

Current technologies for painting TPOs involve adjustment of the nonpolar surface to make it more polar, or coating the surface with a tie-layer, commonly called an *adhesion promoter*. The more technical aspects of coating for adhesion, surface wetting, and surface energetics will be discussed in some detail in later sections of this chapter. At this point we wish to identify the common methods used for surface treatment: (1) flame, (2) plasma, (3) UV light, (4) corona, and (5) chemical treatment. Some comparisons of these treatment methods have been published by several authors (2–4). Of these methods, the first two appear to be used most often on a commercial scale, worldwide. In North America, however, the trend is toward using adhesion promoters rather than treating the surface. Using an adhesion promoter is probably the most effective, most robust, and most versatile process, but also the most expensive and environmentally unfriendly. One of the major concerns of the adhesion promoter system is its high volatile organic compounds (VOC) or solvents (5). Ordinarily the solids content is less than about 35% by weight.

An alternate method of addressing the problem would be to create a tie-layer by an inside out approach, that is by adding polar materials to the TPO and “driving” the polar materials to the surface. Conceptually this is not at all difficult to visualize, but on deeper reflection this is a daunting task fraught with some potentially serious drawbacks that must be overcome: (1) getting the polar additive out in a timely and uniform way under varying molding conditions; (2) making the polar functionality available for the paint to react with it; (3) getting enough reaction to render strong, durable bonds that will be exposed to various environments such as, fuel, moisture, UV, humidity, etc.; (4) maintaining a tie-in to the near-surface TPO material in order to provide durability; (5) minimizing the polar additives effect on the bulk properties due to incompatibility; (6) obtaining an economically friendly system that is attractive from a cost basis; and (7) ensuring that quality control methodology is reliable and accurate enough to assure good paint performance.

Who needs a directly paintable TPO (DPTPO)? The main advantages would be (1) a better cost balance, (2) low VOC, (3) fewer steps, (4) better control, (5) potential to use painted parts in regrind, and (6) less plant space required. The main cost savings would be in the elimination of the adhesion promoter, which has been estimated to be from \$1.50 to \$3.00 a part depending on cost per gallon of paint, surface area covered, transfer efficiency (TF), and dry film thickness (DFT) (M. Dziatczak of Basell Polyolefins, private communication). This estimate of cost doesn't take into account the additional cost savings from eliminating recycling, collecting, or dealing with the VOC problem.

Anything you add to TPO to make it directly paintable will add to the material cost because TPO is less than \$1.00 per pound. The material cost increase that seems to be what parts producers are willing to absorb for the TPO is between about \$0.15 to \$0.25 per pound of TPO, which is roughly half the cost savings from eliminating the adhesion promoter. In addition, this does not include the cost savings that can be realized by being able to recycle some level of regrind of the painted parts into the more polar DPTPO formulations. It is still difficult to convince most resin users that a resin cost increase will lead to an overall cost savings by calculation, considering the overall system. It is far easier to show that a resin cost decrease will lead to a cost savings, and understandably so. Key elements to the success of moving DPTPO into commercial use are (1) clear and careful thinking, (2) a good, well thought out plan, and (3) an investment (which are basically all the key ingredients of any sound decision of an advance in technology).

## 2 THEORY OF ADHESION AND SURFACE ENERGETICS

Polyolefins are nonpolar and paints are polar. So painting a TPO, from an overall general everyday experience standpoint, is like trying to get water to wet out

onto “solid” oil and make it stick. It does not appear that a simple, naïve approach of just adding something polar to the TPO would lead to the successful development of a DPTPO. It should be obvious without stating, but I will state it anyway, that polar does not like nonpolar the way “water and oil don’t mix.” Polar materials do not want to be in a nonpolar TPO, so they will either disrupt the structure in trying to get out, or if they can get out, they will stay out. But on rare occasions what may be considered naïve has met with success. Take for example the Bernal and Crowfoot discovery that proteins do give a crystalline x-ray diffraction pattern in spite of the emphatic position that proteins are colloids steadfastly held to by the world famous scientist, Willstater (who coincidentally was a colloidal chemist) (6). Significant discoveries are made in such ways, but so are embarrassing failures.

In a deeper sense, we should view this problem in thermodynamic terms, which means systems will move toward their equilibrium or low energy state; and in kinetic terms, which means how much time it will take to get to the equilibrium state. The details on this have been treated by many who were concerned with polymer-polymer miscibility or miscibility of polymer blends (7–9).

The challenge is to develop a DPTPO by adding polar material(s) or polymer(s):

1. Without disrupting the desirable TPO material properties
2. That can easily (from a process sensitivity standpoint) be on or near the surface
3. While getting a uniform distribution on the surface, near the surface, and in the bulk
4. While maintaining a tie-in to the bulk or underlying near surface
5. Without disrupting the near-surface morphology and weaken that portion of the part
6. That have the right functionality of the polar additive to react or bond with the paint functionality
7. While having a good service life when exposed to UV, heat, oxygen, moisture, and solvents
8. That are environmentally friendly, even recyclable
9. That afford an economic incentive (to many people this is probably the most important)

Wetting out a liquid on to a solid is treated first by considering the well-known Young equation (8),

$$\gamma_{SL} = \gamma_S - \cos \theta \gamma_L \quad \text{Eq. (1)}$$

$\gamma_{SL}$ —the interfacial energy between the solid and the liquid (the energy required to spread the liquid out or create an interface)

$\gamma_s$ —the surface energy of the solid (the energy necessary to increase the surface of the solid)

$\gamma_L$ —the surface energy of the liquid (the energy necessary to increase the surface of the liquid)

which is valid at equilibrium. Figure 1 shows a representation of the physical situation.

When  $\theta$  is zero,  $\cos \theta$  is 1, and wetting occurs with the surface energy of the solid being equal to or greater than the liquid, depending on the interfacial energy. The surface energies of the solid, the liquid, and the interface are material properties; the contact angle is measured. One can see that liquids with low surface energy will wet out onto solids with high surface energy, because the vector force is to “pull the liquid down.” This means that oil (low surface energy) spreads out on water (high surface energy), but water (paint in this case), doesn’t spread out on oil (“solid oil” like polyolefins).

For a given  $\gamma_{SL}$ , interfacial energy, a high surface-energy solid is necessary because the surface energy of the liquid is reduced by the  $\cos \theta$ , which varies from 0 to 1. The interfacial surface energy is an important component of this equation, but can not be measured directly (9). The surface energy of the solid can be determined by extrapolation from liquid homologs (8) or by wettability data with various surface-tension liquids. A theoretical model is needed to relate the interfacial energy to the surface energy of the two components. Good and Girifalco developed a very early model; however, this model did not include the fact that the surface energy has two components: a dispersion component,  $\gamma^d$ , and a polar component,  $\gamma^p$ , for each material. The term dispersion comes from the fact that the perturbation of electronic motion that creates this force is related to the perturbation of light with frequency (or dispersion of light) (8).

The adhesion between the two materials is described by the following equation where  $W_{AB}$  is the work of adhesion,  $\gamma_A$ ,  $\gamma_B$ , and  $\gamma_{AB}$  are the surface

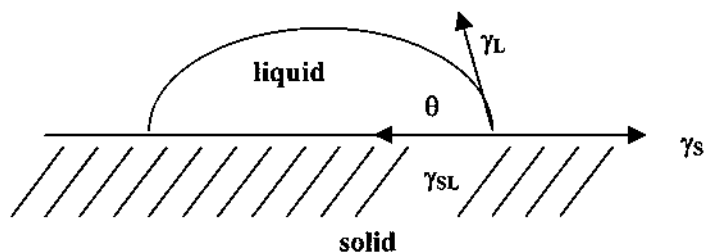

FIG. 1 Spreading of liquid onto solid and contact angle.

energies of material A, material B, and the interfacial surface energy between A and B, respectively (8).

$$W_{AB} = \gamma_A + \gamma_B - \gamma_{AB} \quad \text{Eq. (2)}$$

For a high work of adhesion (e.g., good paint adhesion) the materials are difficult to separate, unless a strong enough force is applied to exceed the work of adhesion. It can be seen from Eq. (2) that a small interfacial surface energy (which is the energy necessary to create a surface between the A and B) would lead to greater work of adhesion. It should be stated here that when the interfacial energy is zero, the materials are thermodynamically miscible. It can also be seen that high surface-energy materials (typical of polar materials), also lead to high work of adhesion. Realizing that it is desirable to minimize the interfacial energy between the surface of the TPO (material A) and the paint surface energy (material B), we set out to do this utilizing the considerations below.

All materials have both a polar ( $\gamma_A^p$ ) and nonpolar ( $\gamma_A^d$ ) or dispersion contribution to the total surface energy. There are two main models for determining the interfacial energy that consider both contributions to surface energetics for each material—the harmonic mean model and the geometric mean model (9).

The harmonic mean model is as follows:

$$\gamma_{AB} = \gamma_A + \gamma_B - (4\gamma_A^p \gamma_B^p)/(\gamma_A^p + \gamma_B^p) - (4\gamma_A^d \gamma_B^d)/(\gamma_A^d + \gamma_B^d) \quad \text{Eq. (3)}$$

The geometric mean model is as follows:

$$\gamma_{AB} = \gamma_A + \gamma_B - 2(\gamma_A^p \gamma_B^p)^{1/2} - 2(\gamma_A^d \gamma_B^d)^{1/2} \quad \text{Eq. (4)}$$

To minimize the interfacial energy, the polar and nonpolar contributions for the two materials should match. To see this, consider material A has a 20/1 polar to nonpolar surface energy and material B has a 1/20 polar to nonpolar surface energy (total surface energy for each material is 21 erg/cm<sup>2</sup>). The interfacial energy,  $\gamma_{AB}$ , is 24 erg/cm<sup>2</sup> by Eq. (4). Contrast this with each material having a 10.5/10.5 polar to nonpolar surface energy, which would lead to a value of zero (0 erg/cm<sup>2</sup>) for the interfacial energy, or a minimum of interfacial energy and a maximum for adhesion.

It can be seen from Figure 2, which is a plot of interfacial energy for two materials, A and B (each of which has a total surface energy of 21 erg/cm<sup>2</sup>) as a function of the polar surface energy of material A (or the dispersion surface energy of material B), that a match of dispersion and polar gives an interfacial energy minimum. For the sake of simplicity, we assumed a symmetrical balanced contribution for each material between the dispersion and polar contributions to the total surface energy.

Both the harmonic mean model and the geometric mean model will be used to determine the surface energy of the solid surface along with the polar

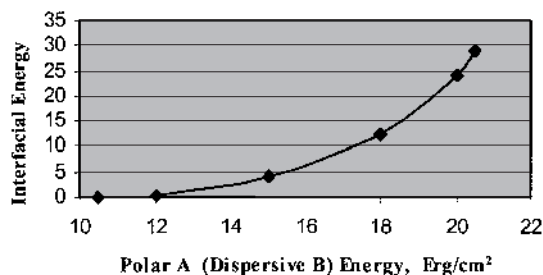

FIG. 2 Interfacial energy of AB material blend.

and dispersion contributions for the compositions considered in the formulation section.

### 3 THE CHEMISTRY

Chemistry is required for the paint to cure and bonds to form to provide the forces that are necessary to achieve the desired paint properties, and also to obtain the adhesion of the paint to the substrate or TPO (the material of focus). The classification of paint curing as a chemical change is obvious, just as the classification of a phase change—such as melting of a solid—as a physical change is also obvious; however, the lines get a little blurred when we start to include the interactions of strong polarity, hydrogen bonding, charge transfer, etc. Realizing that these all stem from one force of nature (the electromagnetic force); and that the other three forces (10) (gravity, the strong nuclear force, the weak nuclear force) are of no consideration here. Probably a good way to classify the forces involved is the one used by Coleman (11), wherein at the lower end of the scale are the weak “physical” forces, generally referred to as van der Waals forces, in which the force is proportional to the inverse sixth power of the distance between the interacting species; and at the upper end, strong “chemical” forces, such as ionomers, charge transfer, and of course the classical “chemical reaction” such as acid-base, alcohol-acid, etc. Hydrogen bonding is classified by Coleman as a chemical change, and of intermediate strength. However, as Wu points out, it is not a primary chemical bond and is mainly of ionic character by nature (8). This classification becomes important as we consider the chemical species involved in the process of paint adhesion and achieving good adhesive strength; they also become important in our selection process of materials to consider as key formulation factors. Thirdly, they become important as we try to develop a deeper understanding, and a working model to explain the results and build on them to achieve a final objective of a useful, commercial material.

#### 4 STRENGTH OF BONDS

##### 1. Physical Bonds

- a. Random dipole-induced dipole (London forces)

$$E = f(\text{ionization potential, polarizability})/r^6 \quad \text{Eq. (5)}$$

Strength  $\sim 5$  kcal/mol

- b. Dipole-induced dipole (Debye)

$$E = f(\text{dipole moment, polarizability})/r^6 \quad \text{Eq. (6)}$$

Strength  $\sim 5$  kcal/mol

- c. Dipole-dipole (Keesom)

$$E = f(\text{dipole moment})/r^3 \quad \text{Eq. (7)}$$

or

$$E = f(\text{dipole moment, } 1/T)/r^6 \quad \text{Eq. (8)}$$

Strength  $\sim 8$  kcal/mol

- d. Ion-dipole

$$E = f(\text{dipole moment, charge})/r^2 \quad \text{Eq. (9)}$$

Strength  $\sim 5\text{--}10$  kcal/mol

##### 2. Chemical Bonds

- a. Hydrogen bonding

$$E = f(\text{acceptor / donor attraction})/r^6 \quad \text{Eq. (10)}$$

Strength  $\sim 5$  to 40 kcal/mol

- b. Covalent bonding

Strength  $\sim 20$  to 200 kcal/mol

- c. Ionic bonding

Strength  $\sim 120$  to 250 kcal/mol

To exemplify how dramatically the energy drops off with distance for a van der Waals attraction ( $r^{-6}$  dependency):

assume  $E = 20$  kcal/mol for  $r$

and  $E = 0.3$  kcal/mol for  $2r$

This means that for a typical attraction with dimensions between centers of a few angstroms, the driving force of energy released due to bonding becomes very small just a short distance from the equilibrium bond distance. Thermal motions, steric hindrance, or segmental restrictions make disruption easy.

For a lower order distance dependency, such as ion-dipole, the energy reduction at twice the distance is much less:

assume  $E = 20$  kcal/mol for  $r$  (for  $r^{-2}$  dependency)

and  $E = 5$  kcal/mol for  $2r$

For a typical ionic bond (12) as the centers approach each other, they are sucked into the potential energy well. At a distance of  $r$  of 2.3 Å, the bond energy is 122 kcal/mol and at almost twice the distance, 4 Å, the energy is still very high at 82 kcal/mol. Covalent bonds behave in a similar fashion.



Other key factors that are important are geometrical considerations (as in the case with hydrogen bonding) and spacing between the segments involved (which could make near distances forces difficult to realize). In the case of proteins, many hydrogen bonds are formed, which lock the structure into place.

The paint chemistry must now be considered. The details of all the paint chemistries involved can be found in several good books on coatings (13,14). To simplify the situation, we will mention the most prominently used systems, which are the ones involved in the development of directly paintable TPOs, and which have been the ones most commonly used by the automotive industry for painting TPOs. The urethane chemistry used for paint involves isocyanate groups and hydroxyl groups, the reaction of which forms a urethane. Of course, there are catalysts included and a great deal of formulation work with the ingredients involving various molecular weights and chemically functional groups, but what is important for our purpose is the main reactions or functionality that would guide in the selection of additives for TPO. Figure 3 shows a representation of the isocyanate-hydroxy reaction to form a urethane. The isocyanate can also react with amines to form ureas (just replace the O with an N in the structure, but don't leave out the extra hydrogen). Hydroxy-terminated polymers are good materials to consider for addition to TPO. The urethane paints can usually be cured at lower temperature, such as 80°C.

The other predominant chemistry for curing paints involves melamine with ether groups that can react with hydroxyl groups of polymeric paint additives to cure (increase the mole weight) by transesterification with the low mole weight hydroxy-material from the melamine evaporating off (see Fig. 3) (13). Ordinarily curing is done at higher temperatures, for example 121°C. Once again, hydroxy-functionality is useful.

Figures 4 and 5 show representations of hydrogen bond formation between an electron donating group (such as carbonyl or ether) and a hydrogen attached to an electron withdrawing group (such as halogen or carboxylic acid) that makes the hydrogen more available to bond.

## 5 THE FORMULATIONS

### 5.1 Basic Considerations

This section now will discuss work and formulations, some of which have already been disclosed in the literature, and the approach used herein to develop a balance of paint adhesion, durability, and good physical properties. Mainly Clark and Ryntz (15,16), and others (17), have worked on the development of directly paintable TPO using amine-terminated polyethylene oxide (ATPEO) reacted with maleic anhydride grafted polypropylene to form an imide. This allows for a tie-in to the PP matrix and the functionality (presumably through

## Urethane Crosslinking

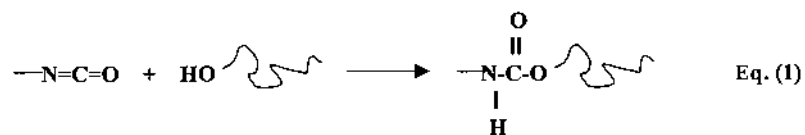

## Melamine Crosslinking

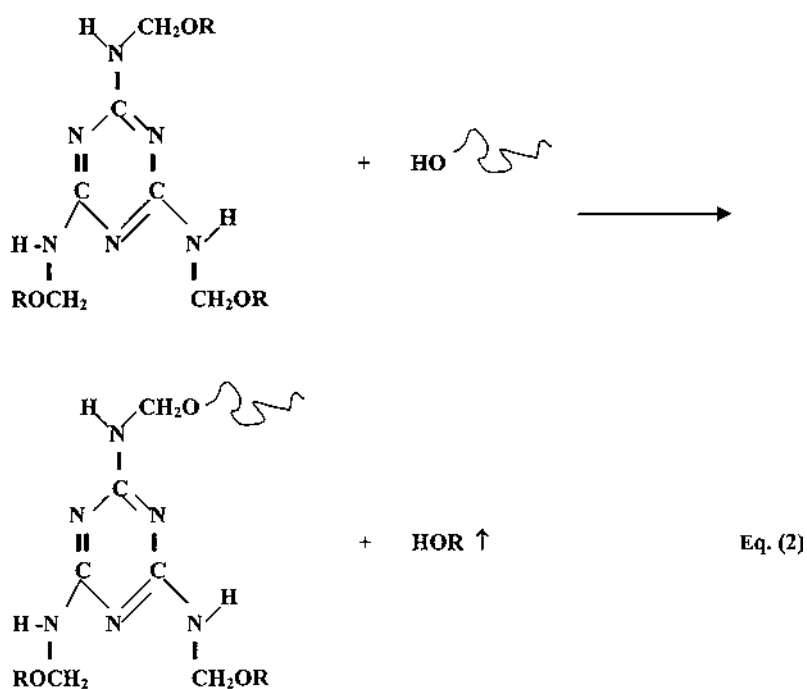

FIG. 3 Paint curing chemistry.

hydrogen bonding of the ethers groups to hydrogen donating groups in the paint, such as hydroxyls) needed to provide paint adhesion. Well-defined compositions with a emphasis on a favorable balance of the level and ratio of the MAgPP and ATPEO were explored. Their work (15,16) is a foundation for continued extension and improvements. The literature (18,19) also shows the use of hydroxyl functionality on PP to improve adhesion to paint. In addition, polyesters

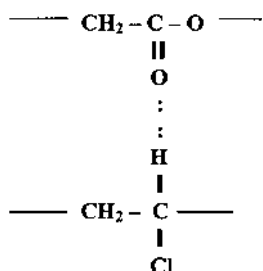

FIG. 4 Hydrogen bonding with halogen substitution and a carbonyl group.

have been added (20) to improve the paint adhesion. A combination of MAgPP and an epoxy resin has also been used (21,22). Other work has been published on improved coatability of TPOs (23,24). By and large, adhesion is addressed with various paints and curing conditions, and various tapes are used to do the testing. In most cases, multiple pulls were not addressed, and the durability was usually not tested or exemplified. This may be due to the fact that both adhesion and durability are difficult to balance. It is difficult to get a good balance of adhesion and durability in a normal TPO with an adhesion promoter (25). The problem is magnified in DPTPO by the necessity of purposely having to add a polar material to the TPO. With the formulations described in the tables and the following text, we will be addressing both adhesion and durability, using a very aggressive adhesion test that involves multiple pulls with a very good adhesive tape that sticks well to the paint (this is critical to a good test) (D. Frazier, formerly of Montell Polyolefins, private communication). The effects of shear on the adhesion results are also evaluated by employing a specific test (uncovered during this work) that is simple yet surprisingly very effective. A conceptual model has been developed to address both these problems and has been utilized to formulate the essential requirements for a commercially acceptable DPTPO.

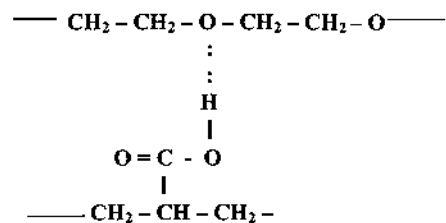

FIG. 5 Hydrogen bonding with an ether group and a hydrogen of a carboxyl group.

From an surface energetics viewpoint, referring back to the section on the theory of adhesion and Eq. (4), the aim is to match the surface energy of the DPTPO with the surface energy of the paint. Table 1 shows the surface energetics of three materials; polyolefin, polyvinylchloride (PVC), and a RIM polyurethane (PU); and two coating materials: adhesion promoter (containing chlorinated polypropylene) and a melamine paint, which represents quite nicely about the average surface energy of paints used for TPO with only about a few points difference from paint to paint. It is easy to see why PVC paints well, because it matches the surface energetics of paint with bonding forces being of the weaker type, which probably involve hydrogen bonding of hydroxyl groups with chlorine. The RIM, most probably, involves some chemical reaction of isocyanate groups in the paint with the hydrogen on the nitrogen group of the RIM urethane; also hydroxyl groups in the paint would form hydrogen bonds with the carbonyl of the RIM urethane. An adhesion promoter would “bridge the gap” in terms of surface energetics between the paint and the TPO, acting as a tie-layer. The target surface energetics for a DPTPO would be to equal, as nearly as possible, the paint surface energetics. One must realize that this energetics match would not guarantee strong, durable bonding of the paint to the TPO, and that the near-surface and deeper-surface effects based on “compatibility” of additives are also critical.

By utilizing several polar ingredients of various degrees of polarity, we have been able not only to effect a better balance of paint adhesion and durability, but also to minimize the of bulk property effects due to the incompatibility of the polar additives. For example, a multicomponent polarity balanced distribution (MCPBD) that utilizes (1) a highly modified propylene polymer, (2) a moderately modified propylene polymer, (3) a polar additive capable of reactivity, and (4) an interfacial modifier of moderately low polarity was developed and has shown good success, not only in the lab, but also when scaled up to commercial size trials. The first grade of DPTPO developed was a low modulus (650 MPa) using this MCPBD model approach. In the development of such materials, it is necessary also to consider the influence of shear forces during molding, on the surface and near surface properties; this will be dealt with later on in this section.

**TABLE 1** Surface Energy Matches

| Surface energy<br>(ERG/cm <sup>2</sup> ) | PO   | PVC  | RIM  | Adhesion<br>promoter | Paint |
|--|------|------|------|----------------------|-------|
| Total                                    | 29.8 | 38   | 21.7 | 44.2                 | 42    |
| Dispersion                               | 27.6 | 31.6 | 13.7 | 38.4                 | 31.5  |
| Polar                                    | 2.2  | 6.4  | 8    | 5.8                  | 10.5  |

## 5.2 Compression Molded Level

As stated previously, notwithstanding this challenge, significant progress has been made by Richard Clark (of Luzenac, formerly of Texaco, private communication) and Rose Ryntz toward the development of a directly paintable TPO, which has contributed significantly to the understanding of such systems and directly paintable TPO in general. We have taken a somewhat similar fundamental approach using reactive functional ingredients, but not just two. By incorporating several other ingredients into the mix, the result was a more advantageous balance of material properties and paint performance with favorable cost considerations.

Table 2 shows the compositions made by compression molding along with the paint adhesion and surface energetics results. In this case, the MAgPP-1 (maleic anhydride grafted PP) used was made by grafting onto the surface of the solid phase. Although the MAgPP-1 shows some polarity (T 2-1) compared to PP (T 2-8), or a PP-EPR blend (T 2-7), it shows no adhesion. This is probably

**TABLE 2** Effect of Functionalized Polyolefins<sup>a</sup>

| Composition                 | T 2-1 | T 2-2 | T 2-3        | T 2-4 | T 2-5 | T 2-6 | T 2-7 | T 2-8 |
|-----------------------------|-------|-------|--------------|-------|-------|-------|-------|-------|
| MAgPP-1                     | 100   | 14    | 14           | —     | 14    | —     | —     | —     |
| PP                          | —     | 56    | 56           | 70    | 56    | 70    | 70    | 100   |
| MAgEPR-1                    | —     | —     | —            | 15    | 15    | —     | —     | —     |
| EPR-1                       | —     | 30    | 30           | 15    | 15    | 30    | 30    | —     |
| ATPEO-1                     | —     | —     | 6            | —     | —     | 6     | —     | —     |
| <i>Paint adhesion</i>       |       |       |              |       |       |       |       |       |
| <i>(% adhesion)</i>         |       |       |              |       |       |       |       |       |
| 1st pull                    | 0     | 100   | 100          | 10    | 100   | 0     | 0     | 0     |
| 2nd pull                    | —     | 100   | 100          | 0     | 100   | —     | —     | —     |
| 3rd pull                    | —     | 100   | 100          | —     | 100   | —     | —     | —     |
| <i>Surface energy</i>       |       |       |              |       |       |       |       |       |
| <i>(Erg/cm<sup>2</sup>)</i> |       |       |              |       |       |       |       |       |
|                             |       |       | <i>WORK</i>  |       |       |       |       |       |
|                             |       |       | <i>model</i> |       |       |       |       |       |
| Total                       | 29.7  | 37.7  | 49.6         | 23.4  | 36.4  | 30    | 28.9  | 28.6  |
| Dispersion                  | 20.7  | 35.7  | 23.3         | 18.5  | 29    | 24.8  | 26.6  | 26.5  |
| Polar                       | 9     | 2     | 26.3         | 4.8   | 7.4   | 5.2   | 2.3   | 2.1   |
| <i>Surface energy</i>       |       |       |              |       |       |       |       |       |
| <i>(Erg/cm<sup>2</sup>)</i> |       |       |              |       |       |       |       |       |
|                             |       |       | <i>Wu</i>    |       |       |       |       |       |
|                             |       |       | <i>model</i> |       |       |       |       |       |
| Total                       | —     | 38    | 52.3         | 28    | 39.6  | 33.3  | 31.3  | 30.7  |
| Dispersion                  | —     | 31.3  | 20           | 19.1  | 27.4  | 23.3  | 24.6  | 24.9  |
| Polar                       | —     | 6.6   | 32.3         | 8.9   | 12.2  | 10    | 6.5   | 5.8   |

<sup>a</sup>Compression molded samples, HAP-9440 paint.

due to the inability to obtain significant diffusion into the molded part (poor diffusion across the crystalline phase). With about 30% rubber, PP, and MAgPP-1, good adhesion is realized with (T 2-3) or without (T 2-2) the amine terminated polyethylene oxide (ATPEO); the former does have very high surface polarity with the latter having very high dispersion energetics. Compare T 2-2 and T 2-3. If a maleic anhydride EPR is used, MAgEPR-1 (T 2-4), somewhat higher polarity is achieved, but the dispersion component is low and the adhesion is poor. Using both the MAgPP-1 and the MAgEPR-1, both polarity and dispersion components are high, and adhesion is good (T 2-5). Based upon adhesion only, it is not necessary to combine the two (MAgPP and MAgEPR), but we will see later that this will become important as we delve into durability, effects of shear, and physical properties. It turns out that the surface energetics of T 2-5 just about match the surface energetics of a typical paint HAP-9940, which is about 30 erg/cm<sup>2</sup> for dispersion, 10 erg/cm<sup>2</sup> for polar, and, obviously, 40 erg/cm<sup>2</sup> total. It will also be noted that just by adding the ATPEO-1 (T 2-6) polarity is increased, but there is not adhesion. Probably because the ATPEO comes to the surface, but has no tie-in. A similar result would also be expected with the addition of various slip additives or surfactants. Both the WORK (Wendt, Owens, Rabel, and Keabele) model and the Wu model were used to determine surface energetics, with the latter giving higher polarity for a simple polyolefin than what is generally accepted in the literature. Therefore, the former or WORK model is to be preferred, in the context of this work.

Table 3 shows results with good adhesion and surface energy when using another type of MAgPP-2 made in a molten process (T 3-1). This MAgPP supplied by Eastman was deemed to be the preferred material for directly paintable TPO (R. Clark, private communication). Again, the ATPEO-1 is not necessary to obtain adhesion for the compression-molded plaques, but certainly does enhance the surface energetics (T 3-2). This becomes important as we move to a better understanding of what is necessary to achieve DPTPO. Formulation T 3-3 with MAgPP added to PP and no rubber phase, both adhesion and surface energetics are poor due to the difficulty of diffusion into what is solely a crystalline phase. The compression molding process is quite different than the injection molding process, as will be seen later, and as others have found. Reyes, et al. (26) have shown good results with compression molding, but virtually not adhesion with injection molded samples of the exact same composition. It is important to note that the availability of sufficient maleic anhydride functionality is all that is needed to obtain adhesion. This functionality reacts with the functional groups in the paint system (which in this case was melamine type). It is also important to note that the MAgPP has to be available on or near the surface, which it apparently is in the case of compression molded samples. For a reactor TPO (RTPO-1), the results (T 3-4 and T 3-5) are the same as for a compounded blend of PP and EPR.

**TABLE 3** Very High Surface Energies<sup>a</sup>

| Composition                 | T 3-1 | T 3-2 | T 3-3 | T 3-4 | T 3-5 |
|-----------------------------|-------|-------|-------|-------|-------|
| PP                          | 70    | 70    | 80    | —     | —     |
| EPR-1                       | 30    | 30    | —     | —     | —     |
| RTPO-1                      | —     | —     | —     | 80    | 80    |
| MAGPP-2                     | 20    | 20    | 20    | 20    | 20    |
| ATPEO-1                     | —     | 6     | —     | —     | 6     |
| <i>Paint adhesion</i>       |       |       |       |       |       |
| <i>(% adhesion)</i>         |       |       |       |       |       |
| 1st pull                    | 100   | 100   | 0     | 100   | 100   |
| 2nd pull                    | 100   | 100   | —     | 100   | 100   |
| 3rd pull                    | 100   | 100   | —     | 100   | 100   |
| 4th pull                    | 100   | 100   | —     | 100   | 100   |
| <i>Surface energy</i>       |       |       |       |       |       |
| <i>(Erg/cm<sup>2</sup>)</i> |       |       |       |       |       |
| Total                       | 31.5  | 57.5  | 27.5  | 34    | 68.4  |
| Dispersion                  | 28.8  | 26.3  | 24.8  | 31.9  | 24    |
| Polar                       | 2.8   | 31.3  | 2.8   | 2.1   | 44.4  |

<sup>a</sup>Compression molded samples, HAP-9440 paint, WORK surface-energy model.

We must keep in mind that the compression molding level is low shear, allows for diffusion to the surface to take place, and is rarely used on a commercial level for the TPOs considered here.

### 5.3 Injection Molded Level

Well, what a difference a process makes. Table 4 show that when scaling up to the injection molding level, what appears to be a good DPTPO formulation for compression molding is poor for injection molding, whether a RTPO (T 4-3CM versus T 4-3IM) or a mechanical blend (T 4-2CM and T 4-2IM). From the surface energetics and ESCS (XPS) measurements the functionality is exposed to the surface for the compression-molded plaques, but not for the injection-molded plaques. For the sake of those who are by nature very suspicious, the *exact* same compound was used to make the compression- and injection-molded plaques (see Table 4). Behind every good experiment there is a good experimenter. Table 5 shows that using the combination of ATPEO and MAGPP is effective for injection molding (T 5-4) and good adhesion and surface energetics are obtained. The adhesion results are consistent with previous work (15–17). The model (comparing the compression-molded results with the injection-molded

**TABLE 4** Injection vs. Compression<sup>a</sup>

| Composition                 | T 4-1IM          | T 4-2CM            | T 4-2IM          | T 4-3CM            | T 4-3IM          |
|-----------------------------|------------------|--------------------|------------------|--------------------|------------------|
|                             | <i>Injection</i> | <i>Compression</i> | <i>Injection</i> | <i>Compression</i> | <i>Injection</i> |
| PP                          | —                | 70                 | 70               | —                  | —                |
| EPR-1                       | —                | 30                 | 30               | —                  | —                |
| RTPO-1                      | 100              | —                  | —                | 80                 | 80               |
| MAGPP-2                     | —                | 20                 | 20               | 20                 | 20               |
| <i>Paint adhesion</i>       |                  |                    |                  |                    |                  |
| <i>(% adhesion)</i>         |                  |                    |                  |                    |                  |
| 1st pull                    | 0                | 100                | 5                | 100                | 0                |
| 2nd pull                    | —                | 100                | 0                | 100                | —                |
| 3rd pull                    | —                | 100                | —                | 100                | —                |
| 4th pull                    | —                | 100                | —                | 100                | —                |
| <i>Surface energy</i>       |                  |                    |                  |                    |                  |
| <i>(Erg/cm<sup>2</sup>)</i> |                  |                    |                  |                    |                  |
| Total                       | 25.6             | —                  | —                | 34                 | 26               |
| Dispersion                  | 22.6             | —                  | —                | 31.9               | 22.3             |
| Polar                       | 3                | —                  | —                | 2.1                | 3.8              |
| <i>ESCA (XPS)</i>           |                  |                    |                  |                    |                  |
| C1s                         | 0.872            | —                  | —                | 0.818              | 0.872            |
| O1s                         | 0.011            | —                  | —                | 0.058              | 0.012            |
| O/C, %                      | 1.4              | —                  | —                | 7.1                | 1.4              |

<sup>a</sup>Injection molded 4 × 6 plaque, HAP-9440 paint.

results) would suggest that the ATPEO, or some such similar more polar, low molecular weight material is needed to help drive or pull the functionality to the surface for injection-molding plaques. As one might expect, too much ATPEO is too incompatible and leads to problems, and not enough ATPEO is not sufficient to “pull” the MAGPP to the region of availability on or near the surface in the injection-molding process.

#### 5.4 Adhesion—Durability Balance

As achieving a durability-adhesion balance was difficult in normal TPO with adhesion promoter (25), so it is in DPTPO; and some may say even more so. From the results in Table 5, two things are evident: (1) Richard Clark’s communication was proven valid because the MAGPP-2 is a better choice (T 5-3 versus T 5-6) and (2) the ATPEO is necessary along with the MAGPP to realize adhesion for injection-molded parts. As the amount of MAGPP and ATPEO increase, better adhesion is achieved (T 5-2 to T 5-4) along with good surface energetics;



**TABLE 5** Adhesion Durability Imbalance<sup>a</sup>

| Composition                            | T 5-1 | T 5-2 | T 5-3 | T 5-4 | T 5-5 | T 5-6 | T 5-7 |
|--|-------|-------|-------|-------|-------|-------|-------|
| RTPO-1                                 | 100   | 100   | 100   | 100   | 100   | 100   | 100   |
| MAGPP-2                                | —     | 12.5  | 20    | 20    | —     | —     | 20    |
| MAGPP-1                                | —     | —     | —     | —     | 12.5  | 20    | —     |
| MAGEPR-1                               | —     | —     | —     | —     | —     | —     | 20    |
| ATPEO-2                                | —     | 2     | 4     | 6     | 2     | 4     | 4     |
| <i>Paint adhesion</i>                  |       |       |       |       |       |       |       |
| <i>(% adhesion)</i>                    |       |       |       |       |       |       |       |
| 1st pull                               | 0     | 75    | 90    | 100   | 0     | 0     | 100   |
| 2nd pull                               | —     | 45    | 90    | 100   | —     | —     | 100   |
| 3rd pull                               | —     | —     | 80    | 100   | —     | —     | 100   |
| 4th pull                               | —     | —     | 45    | 100   | —     | —     | 100   |
| <i>Durability</i>                      |       |       |       |       |       |       |       |
| <i>(% failure)</i>                     |       |       |       |       |       |       |       |
| 50 cycles                              | 0     | 5     | 33    | 55    | 45    | 25    | 0     |
| 100 cycles                             | 0     | 20    | 45    | 90    | 90    | 33    | 0     |
| <i>Surface energy</i>                  |       |       |       |       |       |       |       |
| <i>(E<sub>gr</sub>/cm<sup>2</sup>)</i> |       |       |       |       |       |       |       |
| Total                                  | 25.6  | 33.5  | 36.8  | 39.6  | 28    | 28.5  | 37.9  |
| Dispersion                             | 22.6  | 28.3  | 28    | 27    | 25.4  | 26.4  | 23.3  |
| Polar                                  | 3     | 5.2   | 8.8   | 12.6  | 2.5   | 2.1   | 14.6  |

<sup>a</sup>Injection molded 4 × 6 plaques, HAP-9440 paint, Hot Taber Durability.

but as adhesion improves, durability gets worse. (Figure 6 gives both adhesion and durability as percent failure to more clearly demonstrate the imbalance.) However, by using a combination of MAGPP and MAGEPR, good adhesion, good surface energetics, and good durability are realized (T 5-7). These results are explained by the MCPBD model, which states that creation of a stronger interface between the rubber (in this case MAGEPR) and the PP (in this case MAGPP) is important (comparing T 5-3, T 5-4, and T 5-7). It is also interesting to note that less ATPEO is needed.

For comparison purposes, Table 6 shows how several types of polar additives can be used in combination with MAGPP to achieve good paint adhesion. The one exception appears to be hydroxy-terminated PP (OHPP), which actually seems to interfere a little with adhesion (T 6-1). This may be explained in part by the di-functionality of the OHPP (20), but this is not clear. The other polar additives involved contain either ethylene (T 6-2, T 6-3, T 6-4) or ethylene oxide sequences (T 6-5). Durability is not good for any of these compositions.

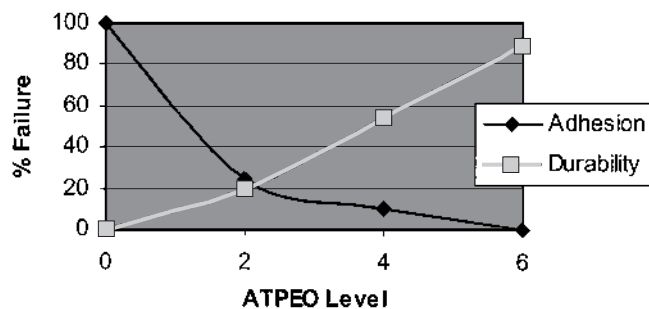

Fig. 6 Adhesion durability imbalance.

The effect of tape type on adhesion is shown in Table 7, where two different systems were used (DPTPO-1 and DPTPO-2 that contain different levels of additives). The masking tape and “Scotch” type tape are not as aggressive as the 3M 898, which is used in all of the formulation work shown in this section with the exception of Table 7, of course. As stated previously, a great deal of the literature seems to use the less aggressive tapes, which do not stick to the paint very well (22,24, and private communications with D. Frazier and R. Clark). This would give better apparent paint adhesion because the force to

TABLE 6 Other Polar Additives<sup>a</sup>

| Composition           | T 6-1 | T 6-2 | T 6-3 | T 6-4 | T 6-5 |
|-----------------------|-------|-------|-------|-------|-------|
| RTPO-1                | 100   | 100   | 100   | 100   | 100   |
| MAGPP-1               | 20    | 20    | 20    | 20    | 20    |
| MAGEPR-1              | —     | —     | —     | —     | —     |
| OHPP                  | 6     | —     | —     | —     | —     |
| OHPE                  | —     | 6     | —     | —     | —     |
| OHPEEO                | —     | —     | 6     | —     | —     |
| OHPEB                 | —     | —     | —     | 6     | —     |
| ATPEO-2               | —     | —     | —     | —     | 6     |
| <i>Paint adhesion</i> |       |       |       |       |       |
| <i>(% adhesion)</i>   |       |       |       |       |       |
| 1st pull              | 65    | 100   | 100   | 100   | 100   |
| 2nd pull              | 25    | 100   | 100   | 100   | 100   |
| 3rd pull              | 10    | 100   | 100   | 100   | 100   |
| 4th pull              | 0     | 100   | 100   | 100   | 100   |

<sup>a</sup>Injection molded 4 × 6 plaque, HAP-9440 paint. Durability is poor for all these compositions.

**TABLE 7** Effect of Tape Used on Adhesion Results<sup>a</sup>

|                       | DPTPO-1 (T 5-4) |               |               | DPTPO-2 (T 5-2) |               |               |
|-----------------------|-----------------|---------------|---------------|-----------------|---------------|---------------|
|                       |                 |               |               |                 |               |               |
| RTPO-1                | 100             | 100           | 100           | 100             | 100           | 100           |
| MAGPP-2               | 20              | 20            | 20            | 12.5            | 12.5          | 12.5          |
| ATPEO-2               | 6               | 6             | 6             | 2               | 2             | 2             |
| <i>Paint adhesion</i> |                 |               |               |                 |               |               |
| <i>(% adhesion)</i>   |                 |               |               |                 |               |               |
| <i>Type of tape</i>   | <i>Masking</i>  | <i>Scotch</i> | <i>3M 898</i> | <i>Masking</i>  | <i>Scotch</i> | <i>3M 898</i> |
| 1st pull              | 100             | 100           | 100           | 100             | 100           | 75            |
| 2nd pull              | 100             | 100           | 100           | 100             | 100           | 45            |
| 3rd pull              | 100             | 100           | 100           | 100             | 98            | —             |
| 4th pull              | 100             | 100           | 100           | 100             | 85            | —             |
| 5th pull              | 100             | 100           | 100           | 100             | 80            | —             |

<sup>a</sup>Injection molded 4 × 6 plaque, HAP-9440.

remove the tape is easily reached before the adhesion strength of the paint to the substrate can come into play.

It was found that by utilizing a simple four-inch diameter disc mold with a pin gate, and testing both near and away from the gate, a very aggressive test could be developed that differentiates good systems from extremely good systems (which are far less sensitive to failure due to the different shear forces involved in injection molding). It is not surprising that there are differences between near and away from the gate, but what is surprising is the power of this type of mold system to differentiate adhesion within only a few short inches difference. Figure 7 shows the difference between near gate (gate) and opposite gate (opp) results with the failure mode being delamination when a high ration of ATPEO to MAGPP is used. It is interesting to note that nonstoichiometric amounts of ATPEO ( $\sim 2 \times 10^{-3}$  equ. amine) to MAGPP ( $\sim 6 \times 10^{-3}$  equ. MA) seems to be best for an adhesion-durability balance. This is consistent with the position that having excess MAGPP is important to adhesion involving the paint chemistry; the more polar ATPEO assists in pulling the MAGPP to the surface. The latter would have the potential to create strong chemical bonds, such as esters, while the former would have the capability of weaker hydrogen bonds with the ether of the ATPEO and hydroxyl groups of the paint system. Figure 8 shows how a better balance system, as far as ATPEO and MAGPP ratio is concerned, gives no delamination and gives good adhesion in both the gate and opposite the gate areas (with the gate area being the weaker). This near gate-opposite gate differentiation will become evident throughout this work with the near gate losing out every time. Some attempts at analysis of the surface by analytical techniques were made, but not a detailed enough picture was formed

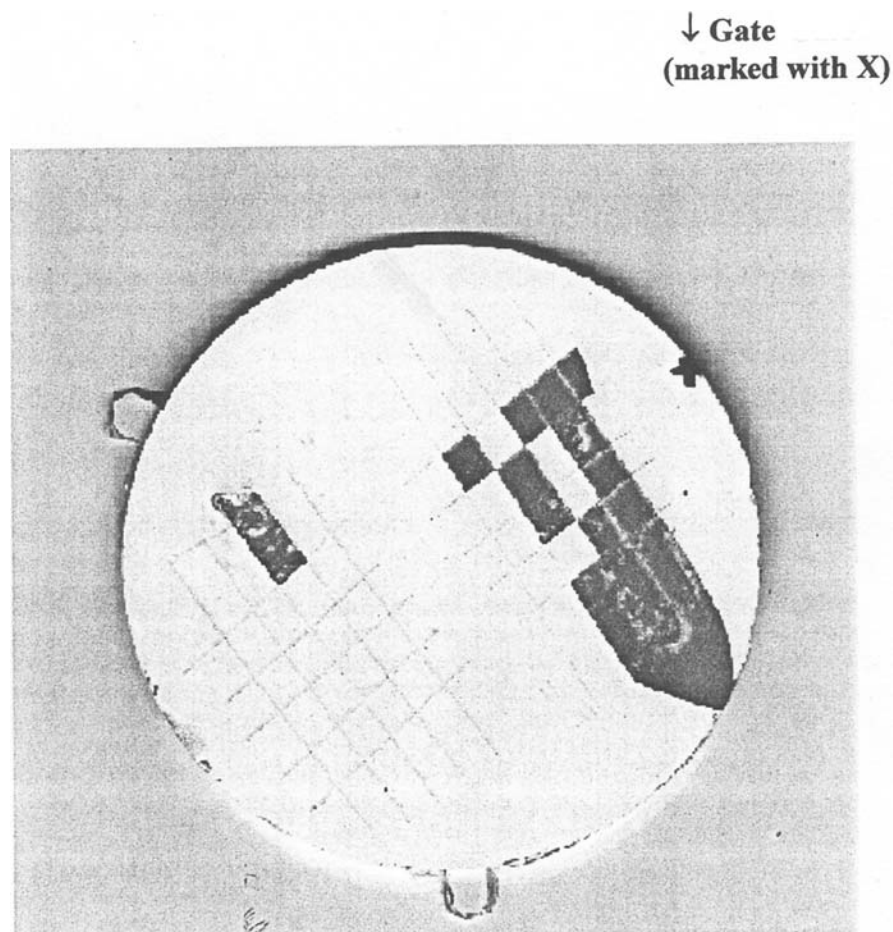

Fig. 7 Delamination of high polar/low MAgPP additive system.

to mention the results in this work. It would be very interesting for work to continue on the analytical side to develop a deeper understanding of the situation.

Table 8 attempts to further build on the MCPBD model by introducing a third polymer ingredient that was believed to potentially provide further strengthening of the rubber-plastic interface. The results achieved give an even better balance of adhesion and durability in addition to improving or minimizing (apparently) the effects of shear to realize both good near and opposite gate adhesion with even better durability. Based on this final model (27,28), compositions were selected for scale-up to commercial levels of production of DPTPO

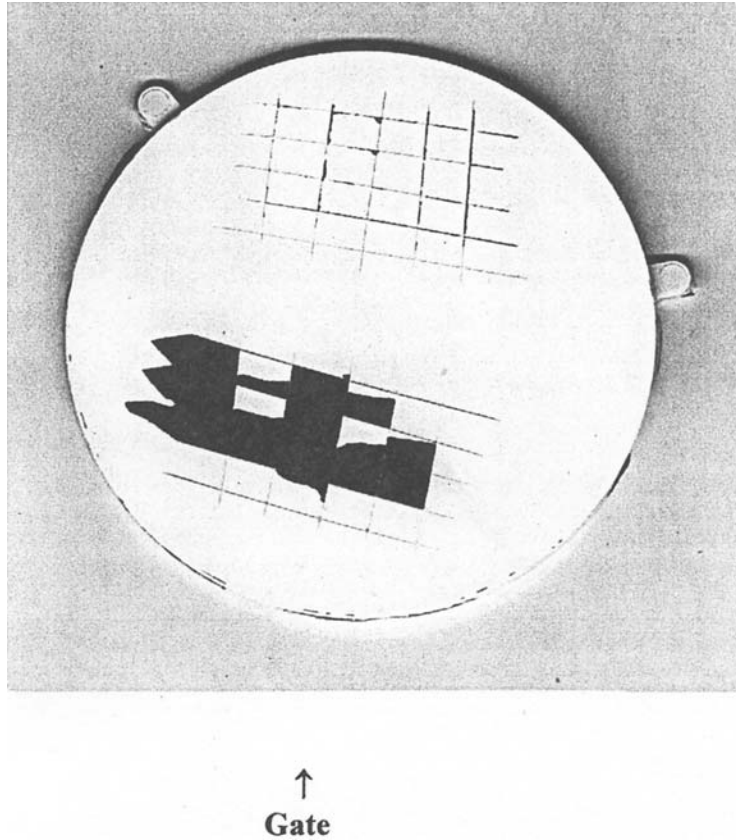

FIG. 8 Better additive system balance—no delamination.

material and parts were molded on commercial-size injection-molding equipment. The first grade of DPTPO developed was a low modulus (650 MPa) using this MCPBD model approach. Typical automotive parts were made and tested for paint adhesion and durability with acceptable results (R.A. Ryntz, private communication).

### 5.5 Paint Type and Curing

Paint systems differ in their cure chemistry and ingredient content, such as melamine, polyester, acrylic, urethane, etc. Some work has been done on determining the results with different paint systems (urethane versus melamine) or similar paint systems from different suppliers, but certainly not as extensive as the work that has been done with adhesion promoter and paint systems on TPOs. In gen-

TABLE 8 Achieving Adhesion Durability Balance<sup>a</sup>

| Composition           | T 8-1    | T 8-2    | T 8-3    | T 8-4    | T 8-5    | T 8-6    | T 8-7    | T 8-8    |
|-----------------------|----------|----------|----------|----------|----------|----------|----------|----------|
| PP                    | —        | —        | —        | —        | —        | —        | 70       | 70       |
| EPR-1                 | —        | —        | —        | —        | —        | —        | 30       | 30       |
| RTPO-1                | 100      | 100      | —        | —        | —        | —        | —        | —        |
| RTPO-2                | —        | —        | 100      | 100      | 100      | 100      | —        | —        |
| MAGPP-2               | 10       | 10       | 10       | 10       | 10       | 10       | 20       | 20       |
| MAGPP-1               | 10       | —        | —        | —        | 10       | —        | —        | —        |
| MAGPP-2               | —        | 10       | 10       | 10       | —        | 10       | —        | —        |
| Epoxy resin           | —        | —        | —        | —        | —        | —        | 3        | 3        |
| PE-1                  | —        | —        | —        | 10       | 10       | 10       | —        | 10       |
| ATPEO-2               | 3        | 4        | 3        | 3        | 3        | —        | —        | —        |
| OHPEEO                | —        | —        | —        | —        | —        | 3        | —        | —        |
| <i>Paint adhesion</i> |          |          |          |          |          |          |          |          |
| (% adhesion)          | Gate/opp | Gate/opp | Gate/opp | Gate/opp | Gate/opp | Gate/opp | Gate/opp | Gate/opp |
| 1st pull              | 70/100   | 80/100   | 100/100  | 100/100  | 100/100  | 100/100  | 37/100   | 85/100   |
| 2nd pull              | 50/100   | 70/100   | 90/100   | 100/100  | 100/100  | 100/100  | 25/100   | 66/100   |
| 3rd pull              | 40/98    | 60/100   | 70/100   | 100/100  | 100/100  | 100/100  | 20/100   | 32/100   |
| 4th pull              | 20/90    | 50/100   | 60/90    | 100/100  | 100/100  | 100/100  | 10/100   | 15/100   |
| <i>Durability</i>     |          |          |          |          |          |          |          |          |
| (% failure)           |          |          |          |          |          |          |          |          |
| 50 cycles             | 10       | 35       | 25       | 0        | 0        | 0        | 45       | 0        |
| 100 cycles            | 15       | 50       | 35       | 0        | 0        | 0        | 70       | 0        |

<sup>a</sup>Injection molded discs, DuPont 872 paint, Hot Taber Durability.

eral, urethanes are lower cure temperatures and melamines are higher cure temperatures. Higher temperatures are preferred to allow for more swelling across the interface to mobilize the reactive species within the TPO system, especially the rubber. Results on large-scale industrial parts with the lower stiffness DPTPO (650 MPa), have shown that both the urethane and the melamine paints yield good paint adhesion and durability. It should be noted that the adhesion test is not as severe, in these cases, because a top clearcoat is used that in general does not give as good adhesion to the tape resulting in a less aggressive test (D. Frazier, private communication), and effects of shear on paint adhesion would also not be as severe as the near gate test using the disc with pin gate (DPGT) because fan gates are used for TPOs in production systems. So, a formulation that might give less than 100% adhesion in the near gate DPGT could very well pass the commercial systems tests. Although, a stronger correlation should be developed to determine the minimum requirements by the DPGT test system that gives acceptable results for production scale parts. The other factor concerning the use of a clear coat is that the durability results are much better with than without it (D. Frazier, private communication). Table 9 shows results with several different paints (all melamine cure), diluted and undiluted. With the DPTPO-3 (650 MPa Basell system) paint adhesion and durability are basically good with some differences seen wherein the undiluted paint shows slightly better adhesion, but better durability than the diluted paints. The HAP-9440 is also slightly better for adhesion, but slightly less durable than the DuPont 872 and 692. These differences are to be expected based on experience with TPO painting using adhesion promoter. Also, without the clear coat, the durability is more severely tested. What is also important is that the DPTPO-4 (epoxy-MAgPP system) without the PE component shows poor durability and poor near-gate adhesion under any circumstances (see Table 9 DPTPO-4 and Table 8 T 8-7 versus T 8-8).

Cure temperature and cure duration (time) are also important parameters relative to paint adhesion. For conservation reasons, lower temperatures and shorted times are most desirable. In Table 10 are listed the results of adhesion testing on DPTPO-3 that show that both under cure and over cure can be undesirable, and that under cure is perhaps the less desirable from the standpoint of obtaining acceptable paint adhesion. This is not inconsistent with the results seen using TPO and adhesion promoter.

## 5.6 Higher Stiffness

Obtaining good paint properties with higher stiffness TPO is known to be a real problem because the amount of rubber is reduced that impedes the development of good diffusion and penetration into the TPO by the paint system. The basic attempt to develop higher stiffness DPTPO centered on using stiffening addi-

**TABLE 9** Effect of Paint Type and Dilution

## A. DPTPO-3 BASELL 650 MPA DPTPO

|                             | Paint                     |                         |                           |                         |
|-----------------------------|---------------------------|-------------------------|---------------------------|-------------------------|
|                             | DuPont 872<br>(undiluted) | DuPont 872<br>(diluted) | DuPont 692<br>(undiluted) | HAP-9440<br>(undiluted) |
| <i>Paint adhesion</i>       |                           |                         |                           |                         |
| <i>(% adhesion)</i>         | <i>Gate/opp</i>           | <i>Gate/opp</i>         | <i>Gate/opp</i>           | <i>Gate/opp</i>         |
| 1st pull                    | 100/100                   | 100/100                 | 100/100                   | 100/100                 |
| 3rd pull                    | 90/100                    | 100/100                 | 87/100                    | 100/100                 |
| <i>Hot Taber Durability</i> |                           |                         |                           |                         |
| <i>(% failure)</i>          |                           |                         |                           |                         |
| 50 cycles                   | 0                         | 18                      | 0                         | 38                      |
| 100 cycles                  | 0                         | 36                      | 0                         | 48                      |

## B. DPTPO-4 EPOXY/MAGPP (T 8-7)

|                             | Paint                     |                         |                           |                         |
|-----------------------------|---------------------------|-------------------------|---------------------------|-------------------------|
|                             | DuPont 872<br>(undiluted) | DuPont 872<br>(diluted) | DuPont 692<br>(undiluted) | HAP-9440<br>(undiluted) |
| <i>Paint adhesion</i>       |                           |                         |                           |                         |
| <i>(% adhesion)</i>         | <i>Gate/opp</i>           | <i>Gate/opp</i>         | <i>Gate/opp</i>           | <i>Gate/opp</i>         |
| 1st pull                    | 37/100                    | 64/100                  | 28/100                    | 35/100                  |
| 3rd pull                    | 20/100                    | 0/95                    | 0/100                     | 20/100                  |
| <i>Hot Taber Durability</i> |                           |                         |                           |                         |
| <i>(% failure)</i>          |                           |                         |                           |                         |
| 50 cycles                   | 45                        | 95                      | 94                        | 100                     |
| 100 cycles                  | 70                        | 95                      | 99                        | 100                     |

tives like talc. This approach has met with some success as shown in Table 11. Good adhesion and durability can be achieved along with acceptable physical properties. Adding talc of course doesn't have a positive effect on the impact. At certain levels of talc, the use of the functionalized component, such as ATPEO becomes unnecessary as can be seen in the results of Table 11. This is somewhat surprising and interesting. Three stiffness grades of DPTPO have been developed that pass the requirements of adhesion and durability exposed to various environmental conditions using standard type tests accepted by automotive (3). This shows viability but not necessarily a commercial success for any specific application, which is not the thrust of this chapter. Once again it should be



**TABLE 10** Effect of Cure Conditions<sup>a</sup>

|                       | Cure time, (min.) |                 |                 |                 |
|-----------------------|-------------------|-----------------|-----------------|-----------------|
|                       | 20                | 30              | 40              | 50              |
| <i>Paint adhesion</i> |                   |                 |                 |                 |
| <i>(% adhesion)</i>   | <i>Gate/opp</i>   | <i>Gate/opp</i> | <i>Gate/opp</i> | <i>Gate/opp</i> |
| 1st pull              | 80/85             | 100/100         | 100/100         | 95/100          |
| 2nd pull              | 70/65             | 92/100          | 100/100         | 90/100          |
| 3rd pull              | 55/40             | 90/100          | 100/100         | 88/100          |
| 4th pull              | 40/30             | 70/98           | 100/100         | 85/100          |
| 5th pull              | 28/25             | 60/88           | 100/100         | 80/100          |

<sup>a</sup>DPTPO-3, DuPont 872, 121° C.

emphasized that the tests used in Table 11 for adhesion and durability are most aggressive (with no top coat) and are not meant to be used as evaluation as standard automotive tests, but are meant to compare formulations for performance relative to each other or to controls.

### 5.7 UV Resistance

Resistance to property deterioration under a variety of conditions is always a concern for any material and UV exposure is certainly a consideration (2). By proper formulation, for example using typical UV stabilizers, adjustments can be made to give acceptable results; but one has to be careful of surface property deterioration because UV stabilizers come to the surface and can interfere and be detrimental to adhesive strength. It appears that the less risky way to achieve UV resistance is to simply add a minimum amount of carbon black. Table 12 shows results of adhesion testing of specific formulations with carbon black that lead to good adhesive strength of the paint and TPO bond when exposed to high levels of UV radiation. Although this shows that UV resistance is certainly achievable by formulation, there are other factors, such as paint type, coating thickness, etc., that need to be studied or finalized to assure acceptable performance.

### 5.8 Conductive DPTPO

The use of electrostatic painting is being employed by many in the industrial applications to achieve better paint efficiencies. The effect of the conductivity of the TPO on paint transfer efficiency (PTE) has been studied (29). Using conductive carbon black in a TPO in surprisingly low amounts can work (30). Using conductive carbon black in DPTPO can also yield conductivity that are expected to give good PTE. An additional advantage with DPTPO would be its improved volume conductivity due to the polar additives.

**TABLE 11** Higher Stiffness DPTPO<sup>a</sup>

| Composition           | T 11-1          | T 11-2          | T 11-3          | T 11-4          | T 11-5          | T 11-6          |
|-----------------------|-----------------|-----------------|-----------------|-----------------|-----------------|-----------------|
| RTPO-2                | 100             | 100             | 100             | 100             | 100             | —               |
| RTPO-3                | —               | —               | —               | —               |                 | 100             |
| MAGPP-2               | 10              | 10              | 10              | 12              | 12              | 10              |
| MAGEPR-2              | 5               | 5               | 5               | 5               | 10              | 10              |
| EPR-2                 | —               | 5               | 5               | 5               | 5               | —               |
| PE-1                  | 10              | 10              | 10              | 12              | 12              | 10              |
| Talc                  | 10              | 15              | 20              | 30              | 50              | —               |
| ATPEO-2               | 3               | —               | —               | —               | —               | —               |
| OHPEEO                | —               | 3               | 2               | —               | —               | 3               |
| <i>Paint adhesion</i> |                 |                 |                 |                 |                 |                 |
| <i>(% adhesion)</i>   | <i>Gate/opp</i> | <i>Gate/opp</i> | <i>Gate/opp</i> | <i>Gate/opp</i> | <i>Gate/opp</i> | <i>Gate/opp</i> |
| 1st pull              | 98/100          | 100/100         | 100/100         | 100/100         | 100/100         | 40/65           |
| 2nd pull              | 76/100          | 100/100         | 100/100         | 96/100          | 96/100          | 30/50           |
| 3rd pull              | 68/100          | 100/100         | 98/100          | 74/100          | 80/100          | —               |
| 4th pull              | 56/00           | 100/100         | 94/100          | 50/100          | 50/100          | —               |
| <i>Durability</i>     |                 |                 |                 |                 |                 |                 |
| <i>(% failure)</i>    |                 |                 |                 |                 |                 |                 |
| 50 cycles             | 0               | 0               | 2               | 3               | 6               | 85              |
| 100 cycles            | 0               | 0               | 8               | 12              | 14              | 95              |
| <i>Flexural</i>       |                 |                 |                 |                 |                 |                 |
| 1% tan (MPa)          | 650             | 725             | 865             | 1050            | 1450            | 1800            |
| <i>Izod impact</i>    |                 |                 |                 |                 |                 |                 |
| -20 C (ft-lbs)        | 11.3            | 2.7             | 1.2             | 0.9             | 0.85            | —               |
| <i>Ceast impact</i>   |                 |                 |                 |                 |                 |                 |
| -30 C (J)             | 42              | 36              | 34              | 22              | 29              | —               |

<sup>a</sup>Injection molded discs, DuPont 872 paint, Hot Taber Durability.

This property has been shown to be effective in improving PTE in non DPTPO systems with certain conductive additives (29), although in those TPO systems high additive amounts are needed. It has also been shown by Helms, et al. (30), that low levels of conductive carbon black can lead to conductivity good enough to improve the PTE significantly, although no system is currently in commercial use at this time, to this authors' knowledge. Table 13 shows how the use of conductive carbon black in the DPTPO systems can give good paint properties and improved conductivity. Although extensive PTE evaluations have not been conducted on DPTPO systems to date, the testing could be done to

**TABLE 12** UV Resistant DPTPO<sup>a</sup>

| Composition           | T 12-1 | T 12-2 | T 12-3             | T 12-4 | T 12-5 |
|-----------------------|--------|--------|--------------------|--------|--------|
| RTPO-2                | 100    | 100    | 100                | 100    | 100    |
| MAgPP-2               | 10     | 10     | 10                 | 10     | 10     |
| MAgEPR-2              | 5      | 10     | 10                 | 10     | 5      |
| EPR-2                 | 7      | —      | —                  | —      | 7      |
| PE-1                  | 10     | 10     | 10                 | 10     | 10     |
| Talc                  | 10     | 10     | 10                 | 10     | 15     |
| OHPEEO                | 3      | 3      | 3                  | 3      | 3      |
| Carbon Black Conc.-1  | —      | 0.11   | —                  | —      | —      |
| Carbon Black Conc.-2  | —      | —      | —                  | 1      | 2      |
| UV absorber           | —      | —      | 0.14               | —      | —      |
| <i>UV resistance</i>  |        |        | <i>0 hours</i>     |        |        |
| <i>Paint adhesion</i> |        |        |                    |        |        |
| <i>(% adhesion)</i>   |        |        |                    |        |        |
| 1st pull              | 100    | 100    | 100                | 100    | 100    |
| 2nd pull              | 100    | 100    | 100                | 100    | 100    |
| 3rd pull              | 100    | 100    | 100                | 100    | 100    |
| <i>UV resistance</i>  |        |        | <i>200 hours</i>   |        |        |
| <i>Paint adhesion</i> |        |        |                    |        |        |
| <i>(% adhesion)</i>   |        |        |                    |        |        |
| 1st pull              | 50     | 70     | 100                | 100    | 100    |
| 2nd pull              | 20     | 50     | 100                | 95     | 100    |
| 3rd pull              | —      | —      | 100                | 80     | 100    |
| 4th pull              | —      | —      | 100                | 75     | 100    |
| <i>UV resistance</i>  |        |        | <i>500 hours</i>   |        |        |
| <i>Paint adhesion</i> |        |        |                    |        |        |
| <i>(% adhesion)</i>   |        |        |                    |        |        |
| 1st pull              | NA     | NA     | 100                | 93     | 100    |
| 2nd pull              |        |        | 100                | 82     | 100    |
| 3rd pull              |        |        | 100                | 60     | 100    |
| 4th pull              |        |        | 100                | 22     | 100    |
| <i>UV resistance</i>  |        |        | <i>1,400 hours</i> |        |        |
| <i>Paint adhesion</i> |        |        |                    |        |        |
| <i>(% adhesion)</i>   |        |        |                    |        |        |
| 1st pull              | NA     | NA     | 95                 | 53     | 100    |
| 2nd pull              |        |        | 88                 | 23     | 100    |
| 3rd pull              |        |        | 73                 | —      | 100    |
| 4th pull              |        |        | 64                 | —      | 100    |

<sup>a</sup>Xenon arc, center of disc tested.

**TABLE 13** Conductive DPTPO<sup>a</sup>

| Composition                 | T 13-1          | T 13-2          | T 13-3          | T 13-4          | T 13-5          |
|-----------------------------|-----------------|-----------------|-----------------|-----------------|-----------------|
| RTPO-2                      | 100             | 100             | 100             | 100             | 100             |
| MAGPP-2                     | 10              | 10              | 10              | 10              | 10              |
| MAGEPR-2                    | 5               | 5               | 5               | 5               | 5               |
| EPR-2                       | 5               | 5               | 5               | 5               | 5               |
| PE-1                        | 10              | 10              | 10              | 10              | 10              |
| Talc                        | 10              | 10              | 10              | 10              | 10              |
| ATPEO-2                     | 3               | 3               | 3               | 3               | 3               |
| Conductive CB-1             | —               | 2               | 4               | —               | —               |
| Conductive CB-2             | —               | —               | —               | 2               | 4               |
| <i>Paint adhesion</i>       |                 |                 |                 |                 |                 |
| <i>(% adhesion)</i>         | <i>Gate/opp</i> | <i>Gate/opp</i> | <i>Gate/opp</i> | <i>Gate/opp</i> | <i>Gate/opp</i> |
| 1st pull                    | 100/100         | 100/100         | 100/100         | 100/100         | 100/100         |
| 2nd pull                    | 100/100         | 100/100         | 100/100         | 100/100         | 100/100         |
| 3rd pull                    | 100/100         | 100/100         | 96/100          | 98/100          | 93/98           |
| 4th pull                    | 100/100         | 100/100         | 88/94           | 92/100          | 85/96           |
| <i>Conductivity</i>         |                 |                 |                 |                 |                 |
| Charge decay                | poor            | fast            | very fast       | fast            | very fast       |
| Resistance                  | high            | low             | very low        | low             | very low        |
| <i>Hot Taber Durability</i> |                 |                 |                 |                 |                 |
| <i>(% failure)</i>          |                 |                 |                 |                 |                 |
| 50 cycles                   | 0               | 0               | 2               | 0               | 6               |
| 100 cycles                  | 0               | 2               | 7               | 5               | 14              |

<sup>a</sup>Injection molded discs, DuPont 872 paint, Hot Taber Durability.

resolve this issue and determine to what extent reformulation work would be necessary.

### 5.9 Selective Elimination Model

When dealing with multiple ingredients added to formulations, or adjustment of polymers (or materials in general) for balance property benefits, one method that has been employed by this author may be termed “selective elimination.” For example, with DPTPO formulations described in this section that contain five ingredients, the function and effect of each is difficult to determine without some extensive formulation and testing or some standard statistical design method or system. Selective elimination method simply selectively eliminates each ingredient from the formulation to develop a matrix of only six experiments. In this case, one experiment or formulation for each of the five ingredients that is selec-

tively eliminated from the formulation, and one formulation that contains all five of the ingredients. Table 14 shows an example of the method of selective elimination. A great deal can be learned with a few experiments. Major effects (main effects in a statistical sense) and interactions can be identified for ingredients and properties of interest. For example, good adhesion is realized with inclusion of all ingredients (T 14-1), but eliminate the MAgPP (T 14-3) and adhesion is lost. Eliminate the PE-1 (T 14-4) and adhesion is reduced a little; eliminate the talc (T 14-5) and adhesion is still good; eliminate the MAgEPR (T 14-2) and adhesion reduced by a small amount; eliminate the ATPEO (T 14-6)

**TABLE 14** Selective Elimination Method<sup>a</sup>

| Composition               | T 14-1          | T 14-2          | T 14-3          | T 14-4          | T 14-5          | T 14-6          |
|---------------------------|-----------------|-----------------|-----------------|-----------------|-----------------|-----------------|
| RTPO-2                    | 100             | 100             | 100             | 100             | 100             | 100             |
| MAgEPR-2                  | 5               | —               | 5               | 5               | 5               | 5               |
| MAgPP-2                   | 10              | 10              | —               | 10              | 10              | 10              |
| PE-1                      | 10              | 10              | 10              | —               | 10              | 10              |
| Talc                      | 10              | 10              | 10              | 10              | —               | 10              |
| ATPEO-2                   | 3               | 3               | 3               | 3               | 3               | —               |
| <i>Pain adhesion</i>      |                 |                 |                 |                 |                 |                 |
| <i>(% adhesion)</i>       | <i>Gate/opp</i> | <i>Gate/opp</i> | <i>Gate/opp</i> | <i>Gate/opp</i> | <i>Gate/opp</i> | <i>Gate/opp</i> |
| 1st pull                  | 72/100          | 60/100          | 0/10            | 78/100          | 94/100          | 98/100          |
| 2nd pull                  | 68/100          | 52/95           | 0/0             | 75/98           | 75/100          | 74/100          |
| 3rd pull                  | 52/100          | 42/68           | —               | 50/80           | 70/100          | 50/98           |
| 4th pull                  | 42/98           | 36/56           | —               | 40/72           | 44/76           | 46/74           |
| <i>Durability</i>         |                 |                 |                 |                 |                 |                 |
| <i>(% failure)</i>        |                 |                 |                 |                 |                 |                 |
| 50 cycles                 | 0               | 0               | 80              | 90              | 0               | 0               |
| 100 cycles                | 8               | 0               | 90              | 85              | 0               | 0               |
| <i>Dynamic impact (J)</i> |                 |                 |                 |                 |                 |                 |
| –30 C                     | 32              | 10              | 35              | 36              | 24              | 38              |
| –40 C                     | 16              | 2               | 28              | 26              | 5               | 27              |
| <i>Izod impact</i>        |                 |                 |                 |                 |                 |                 |
| –20 C                     |                 |                 |                 |                 |                 |                 |
| (ft-lbs/in)               | 2.7             | 1.3             | 2.6             | 2.3             | 1.7             | 2.6             |
| <i>Flexural modulus</i>   |                 |                 |                 |                 |                 |                 |
| (MPa)                     | 550             | 625             | 495             | 605             | 595             | 444             |

<sup>a</sup>Injection molded discs, DuPont 872 paint, Hot Taber Durability.

and the adhesion is still good (this is a surprise that one would probably not predict or may not even find because you probably wouldn't look for it). This demonstrates some of the power of selective elimination. Analysis of the durability results shows that the key ingredient for this property is the PE-1; without it durability suffers significantly. Formulation T 14-3 without the MAgPP does have a little adhesion. Apparently the adhesion is not good enough to allow for the positive interaction effect of the PE-1 on durability to come into play. This same kind of analysis can be done on all the properties. There may be some way to describe this method of selective elimination in a mathematical relationship of the properties to the ingredients, but it is beyond the scope of this chapter. Interested statisticians are invited to use or abuse this method, but personally, I like it.

### 5.10 Modified Paint and Polymer System

There has been an alternate approach to painting TPOs that essentially involves making the paint less polar, to match more nearly the surface energetics of the TPO. The additives are basically hydroxy-terminated hydrogenated polybutadiene that is also termed *hydroxy terminated ethylene butene copolymer* (OHPEB). This involves a very drastic change in the paint formulation, with significant amounts of the additive (31). The paint properties are effected by this change, and it is very difficult to match the properties of the standard, more polar paints. Formulating the paints for painting onto TPO adds cost to the paint system; the overall cost savings by eliminating the adhesion promoter and using the modified paint has not been completely defined. The cost of this specially developed TPO paint would be very formulation dependent and volume-usage dependant. Those who have developed this technology appear to show an overall cost advantage, although it is not clear if PTE has been considered. What is believed by this author (and others) (32) is that by employing a paint formulation-TPO formulation marriage of technologies, the best balance can be achieved by minimizing the reformulation effect for DPTPO (less additives should be needed) and by minimizing the reformulation effect for the paint (also less additives should be needed). Although it has not been explicitly stated that the intent of minimizing the additives was the objective, some results of using paint modification and TPO modifications have been put forth (33). Not knowing which proceeded which (ties may even be possible), the technology marriage has also been attempted and exemplified herein. Table 15 shows that the TPO doesn't give adhesion by itself with normal paint (T 15-1) or with a small amount of olefin type additive in the paint (T 15-4). As would be expected, lower amounts of DPTPO additives (T 15-2) don't give as good adhesion as higher amounts (T 15-3). However, when combined with slightly modified paint, the TPO needs only to be slightly modified to show good results (T 15-5). Although, the details of the property effects on the minor paint modification and

**TABLE 15** Modified Paint and Polymers System for Direct Paintability<sup>a</sup>

| Composition                 | T 15-1          | T 15-2          | T 15-3          | T 15-4          | T 15-5          | T 15-6          |
|-----------------------------|-----------------|-----------------|-----------------|-----------------|-----------------|-----------------|
| RTPO-2                      | 100             | 100             | 100             | 100             | 100             | 100             |
| MAG-EPR-2                   | —               | 2.5             | 5               | —               | 2.5             | 5               |
| MAG-PP-2                    | —               | 5               | 10              | —               | 5               | 10              |
| EPR-2                       | —               | 5               | 5               | —               | 5               | 5               |
| PE-1                        | —               | 5               | 10              | —               | 5               | 10              |
| ATPEO-2                     | —               | 1.5             | 3               | —               | 1.5             | 3               |
| Paint modifier,<br>% by wt. | 0               | 0               | 0               | 5               | 5               | 5               |
| <i>Paint adhesion</i>       |                 |                 |                 |                 |                 |                 |
| (% adhesion)                | <i>Gate/opp</i> | <i>Gate/opp</i> | <i>Gate/opp</i> | <i>Gate/opp</i> | <i>Gate/opp</i> | <i>Gate/opp</i> |
| 1st pull                    | 0/0             | 85/100          | 95/100          | 0/0             | 100/100         | 100/100         |
| 2nd pull                    | —               | 0/30            | 60/100          | —               | 100/100         | 100/100         |
| 3rd pull                    | —               | —               | 55/100          | —               | 100/100         | 100/100         |
| 4th pull                    | —               | —               | 45/100          | —               | 100/100         | 100/100         |
| <i>Durability</i>           |                 |                 |                 |                 |                 |                 |
| (% failure)                 |                 |                 |                 |                 |                 |                 |
| 50 cycles                   | 100             | 0               | 0               | 100             | 5               | 0               |
| 100 cycles                  | 100             | 12              | 0               | 100             | 10              | 10              |

<sup>a</sup>Injection molded discs, DuPont 872 paint, Hot Taber Durability, paint modified OHPEB.

the minor TPO modification have not been fully explored herein, there is little doubt that such a marriage would give better flexibility and commercial benefits. This could be the next major step in the development of directly paintable TPO and painting, printing, or dyeing polyolefins.

## 6 EXPERIMENTAL PREPARATIONS AND TESTING

Both compression molding and injection molding were used to prepare the samples for testing. It is very useful and efficient to work at the compression-molding level to formulate and prepare samples for testing. The process works well if one has at their disposal an internal mixer, such as a Haake or Brabender with a one-half-pound mixing head and Banbury type blades, and a compression molder adjacent to the mixer. From previous experience with other reactive systems, this half-pound level scales up quite nicely to large Banbury mixers and twin screw extruders. For the initial and bulk of the formulation development work, this type of equipment was used. There is also an additional advantage of working at the compression-molding level. The complex interactions of shear are not involved, as in the case of injection molding. This allows one to

develop a more-or-less working model of the polymer ingredients both as individual components and as interacting components with other ingredients. However, as is shown in other sections of this chapter, a direct correlation between compression-molding results and injection-molding results is nonexistent. This however does not mute the conceptual development of a mechanistic working model involving the individual ingredients and their function in achieving the ultimate goal. For example, the development of the multicomponent polarity balanced distribution model (MCPBD) was based on results of work at the compression-molded level. We found it convenient to use a Mylar film interfaced between the material to be compression molded and the metal platens of the compression molder. A thin metal sheet such as aluminum can also be used, and in many cases other experimenters have done this, as a brief examination of the literature can show. It should be noted at this point that the surface composition can be affected by the material that is molded against. This fact has been known for quite some time, but it may be instructive to point this out at this time. It is not the objective here to study the effect of the material being molded against; and it is also quite probable that the results with Mylar and aluminum would be very similar.

For material preparations for injection molding, either a twin screw with corotating intermeshing screws (25 mm or 40 mm WP or Berstorff) or a lab scale Banbury (2.5 lb) was used. Melt temperatures during the mixing process were between about 212°C and 250°C. For injection molding, a 4 in × 6 in × 125 mm with a fan-gate type plaque was used initially, then a pin-gate type four-inch diameter disc was used. With the former, the adhesion and durability was done on the center area. With the later, the adhesion was tested both near the gate and opposite the gate. It was found, surprisingly, that the four-inch diameter disc with the pin-gate design was very useful in evaluating and distinguishing formulations for the sensitivity to mold flow and shear rate. It is obvious that the shear rate and the material flow is very different as it exits from the gate and continues on its path to fill the mold away from the gate, but the short distance of only four inches has dramatic effects on the surface and near-surface properties. Once this was discovered, this type of mold was used for the remainder of the work. Moderate injection speeds were used with a melt temperature of about 200°C and a cycle time of about 40 seconds.

For compression molding, the charge from the Haake mixes was transferred directly to a 4½ in × 4½ in × 80 mm picture-frame mold with the platens of the compression molder set at a temperature of 212°C. The mold was held under pressure of about 15 tons for about three minutes, then transferred to a compression molder with the platens set at room temperature and allowed to cool for about five minutes. The plaques were removed and held for testing.

For painting, a typical lab spray gun was used to coat the plaques or discs to about a 1.5 to 2 mm paint thickness. In general, curing was done at 121°C



for cure times of about 30 to 40 minutes. Painted parts were allowed to stand overnight and before testing. The painted samples were scored with a razor blade giving a lattice design of 16 squares. The 3M 898 type tape was used with multiple pulls to access paint adhesion or removal. None of the plaques or parts were treated or washed in any way before painting. Although, in general, care was taken not to handle the surface of the unpainted plaques excessively before painting. In fact, after the basic DPTPO was developed, the surface of molded parts was purposely touched to contaminate it, then the parts were painted with no evidence of a reduction in adhesion in the areas touched. This experiment demonstrated the robustness of the DPTPO system developed.

For durability, a Taber abrader with a type C scuff head was used to press against the painted surface using a one pound weight of force, and the amount of paint removed (recorded as percent failure) was estimated, after a specific number of cycles with the maximum being 100 cycles. Before testing for durability the painted parts were placed in an oven at about 70°C for one hour to test the Hot Taber Durability. It should be noted that this thin coat with no top clear coat is a more severe test than if a top clear coat were applied for two reasons: (1) a clear coat ordinarily has some slip additive that makes it more difficult to transfer the force to the material below (D. Frazier, private communication), and (2) a thicker coating or in this case two coats would give better results because the stress is transferred to some short distance just below the surface (34).

Physical property testing and melt flow was done with standard tests widely accepted for polyolefins and TPOs.

#### LIST OF MATERIALS

| Material | Description   |
|----------|---|
| PP       | homopolymer polypropylene, melt flow 5 dg/min                     |
| MAgPP-1  | maleic anhydride functionalized PP, surface grafting              |
| MAgPP-2  | maleic anhydride functionalized PP, liquid grafting               |
| EPR-1    | low Mooney C <sub>2</sub> C <sub>3</sub> rubber                   |
| EPR-2    | ethylene-butene plastomer   |
| MAgEPR-1 | maleic anhydride functionalized EPR, intermediate level           |
| MAgEPR-2 | maleic anhydride functionalized EPR, higher level                 |
| RTPO-1   | reactor TPO, melt flow 9 dg/min, 22% C <sub>2</sub>               |
| RTPO-2   | reactor TPO, melt flow 7 dg/min, 27% C <sub>2</sub>               |
| RTPO-3   | high-stiffness TPO  |
| ATPEO-1  | amine-terminated ethylene oxide-propylene oxide copolymer, liquid |

## LIST OF MATERIALS continued

| Material             | Description  |
|----------------------|--|
| ATPEO-2              | amine-terminated ethylene oxide-propylene oxide copolymer, solid |
| OHPP                 | hydroxy-terminated polypropylene                                 |
| OHPE                 | hydroxy-terminated polyethylene                                  |
| OHPEEO               | hydroxy-terminated ethylene-ethylene oxide copolymer             |
| OHPEB                | hydroxy-terminated ethylene-butene copolymer                     |
| Epoxy Resin          | bisphenol A type ether   |
| PE-1                 | low molecular weight polyethylene                                |
| Talc                 | 2 to 4 microns talc  |
| Carbon Black Conc.-1 | low-structure carbon black in LDPE                               |
| Carbon Black Conc.-2 | high-structure carbon black in LDPE                              |
| UV absorber          | hindered amine type  |
| Conductive CB-1      | conductive carbon black, high surface area                       |
| Conductive CB-2      | conductive carbon black, very high surface area                  |

## REFERENCES

1. B Fanslow, P Sarnache. Global TPO/PP bumper fascia consumption, costs, trends. TPOs in Automotive '95, Second International Conference, October 1995.
2. RA Ryntz. Adhesion to Plastics—Molding and Paintability. Global Press, 1998.
3. DA Berta, M Dziatczak. Directly paintable TPO. SPE Automotive TPO Global Conference 2000, Novi, MI, October 2000.
4. R Pierce, M Niehaus. A review of 2K paint performance on exterior grade TPOs utilizing various pre-treatments. TPOs in Automotive '95, Second International Conference, October 1995.
5. RA Ryntz. Painting of plastics. Fed Soc Coat Tech, 1994.
6. M Perutz. Protein Structure. New York: W.H. Freeman and Company, 1992.
7. O Olabisi, et al. Polymer-Polymer Miscibility. New York: Academic Press, 1979.
8. S Wu. Polymer Interface and Adhesion. New York: Marcel Dekker, Inc., 1982.
9. F Garbassi, et al. Polymer Surfaces from Physics to Technology. New York: Wiley, 1994.
10. SW Hawking. A Brief History of Time. New York: Bantam Books, 1988.
11. MM Coleman, et al. Specific Interactions and the Miscibility of Polymer Blends. Lancaster, PA: Technomic Publishing Company, 1991.
12. L Pauling. The Nature of the Chemical Bond. New York: Cornell University Press, 1960.
13. ZW Wicks, Jr, et al. Organic Coatings: Science and Technology. Vols. I and II. New York: Wiley, 1992.
14. MW Urban. Laboratory Handbook of Organic Coatings. Global Press, 1997.

15. R Clark. Polyether amine modification of polypropylene: paintability enhancement. TPOs in Automotive, First International Conference, October 1994.
16. R Clark, RA Ryntz. Toward achieving a directly paintable TPO: initial paintability results. TPOs in Automotive '95, Second International Conference, October 1995.
17. RK Evans, et al. U.S. Patent 6,093,773, 2000.
18. H Shinonaga, S Sogabe. U.S. Patent 5,573,856, 1996.
19. H Harada, et al. U.S. Patent 5,556,910, 1996.
20. J Fock, et al. U.S. Patent 5,565,520, 1996.
21. B-U Nam, et al. U.S. Patent 6,133,374, 2000.
22. S Agro, JD Reyes. International Patent Application WO 99/07787.
23. M Terada, et al. U.S. Patent 5,247,018, 1993.
24. T Mitsuno, et al. U.S. Patent 4,946,896, 1990.
25. DR Blank. A new generation of thermoplastic resins for bumper facias. TPOs in Automotive, Novi, MI, October 1994.
26. JD Reyes, et al. Modified TPO and PP for enhanced paintability and dyeability. TPOs in Automotive '99, Novi, MI, October 1999.
27. DA Berta. U.S. Patent 5,959,030, 1999.
28. DA Berta. U.S. Patent 5,962,573, 1999.
29. S Babinec, et al. Conductively modified TPO for enhanced electrostatic painting. SPE Automotive TPO Global Conference 2000, Novi, MI, October 2000.
30. JH Helms, et al. U.S. Patent 5,959,015, 1999.
31. DJ St. Clair. Polyolefin diol in coatings for thermoplastic olefins. Shell Company, 980707.
32. R Ryntz, JF Chu. European Patent Application EP 0982353 A1.
33. A Wong. Mechanical modeling of durability tests of painted TPO bumper facias. TPOs in Automotive '95, Second International Conference, October 1995.



# 4

## Polymers for Coatings for Plastics

**J. David Nordstrom**

Eastern Michigan University, Ypsilanti, Michigan, U.S.A.

The polymers used for coatings on plastics are no different than polymers used in any other coating. Because plastic substrates have a great variety of physical properties, the coating and the polymers used must fit the application. In this chapter, the synthesis and use of polymers for many coating types will be discussed. Where applicable, specific features that have been built in for specific plastic coatings applications will be discussed.

The component of a coating that provides many, if not all, of the physical property characteristics is the binder. The binder—along with pigments and additives—is the functional part of a coating. In the case of liquid coatings, solvents or water are present to assist in the application of the coating. The binder, or binder system, is usually made up of polymeric materials. In some cases, reactive monomers may be the carrier liquid and they will become part of the binder.

### 1 POLYMER DEFINITION

A polymer is a higher molecular weight molecule created by combining small building block molecules (M) called monomers in a process called polymerization where the monomeric units are joined by chemical bonds.



*Higher molecular weight* has different meanings to users of polymeric materials. For structural materials, polymers have molecular weights of tens to hundreds of thousands. Materials used in plastics have molecular weights of

50,000 to several hundred thousand. On the other hand, polymers used in coatings are more likely to be in the range of several thousand to upward of twenty-thousand molecular weight units. Because of this lower molecular weight, the term *resin* is often used for polymers in coatings.

Typically, there are two types of building block monomers used in polymerization processes. In one case, the monomers contain carbon-carbon double bonds (C=C). When these unsaturated monomers are used for synthesizing polymers, the process is called *chain growth polymerization*. This name describes the way the monomers are formed into polymers—by a chain reaction, that is, one where the polymers are formed in very fast reactions to their final product. Examples of chain growth polymers typically used in coatings are acrylics and vinyls.

In the second type of polymerization process, the polymers are built by a *step growth polymerization*. The monomers typically contain two functional groups that react with complementary functional groups on other monomer molecules. The complementary functional groups react by slower reactions than those in chain growth processes and the polymer chains are built step by step over a much longer period of time. Step growth polymers often take many hours to form, while chain growth polymers are built in seconds. Examples of step growth polymers used in coatings are polyesters, urethanes, and epoxies.

Chain growth polymerization is illustrated by the polymerization of a vinyl monomer with a free radical initiator (Fig. 1). Step growth polymerization is illustrated by the polymerization of a polyester from adipic acid and ethylene glycol in an esterification reaction of the hydroxyl groups and the carboxylic acid groups (Fig. 2).

## 2 CONCEPTS IN POLYMER CHEMISTRY

### 2.1 Molecular Weight

Polymer molecular weights are defined by the length of the polymer chains that are formed by the chain or step growth process. The molecular weight of the

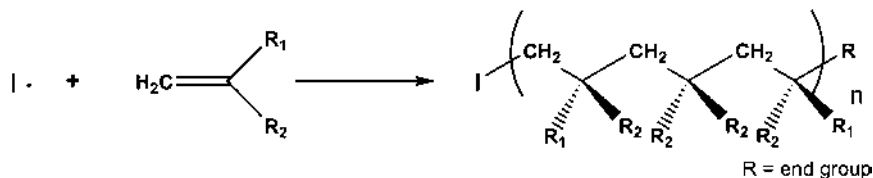

Fig. 1 Chain growth polymerization of C=C.

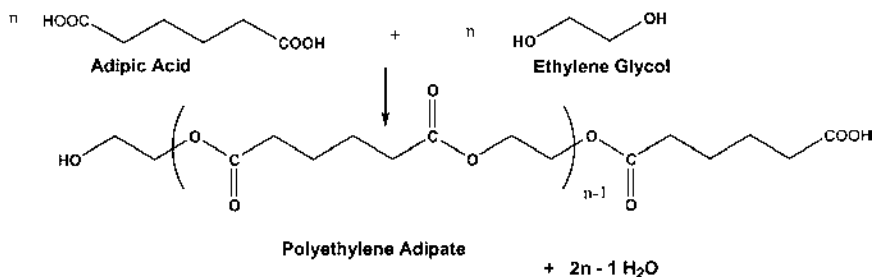

FIG. 2 Step growth polymerization.

polymer is the molecular weight of the monomeric building blocks times the *degree of polymerization*. The degree of polymerization is the number of monomeric units in the polymer chain. As an example, a polymer of methyl methacrylate monomer (molecular weight of 100) that has a degree of polymerization of 100 is 10,000.

$$\text{molecular weight} = \text{DP} \times \text{MW}_{(\text{monomer})} = 100 \times 100 = 10,000$$

The nature of polymerization processes is that they do not make all polymer chains of the same molecular weight. There is a distribution of chain lengths formed. As a result, the molecular weights that describe polymers are averages of the weights of the chains that are formed. Molecular weight averages can be calculated based on the number of polymeric molecules that are present or by the weight of the polymers that are formed. The former method is called Number Average molecular weight ( $M_n$ ) and the latter is called Weight Average molecular weight ( $M_w$ ).

Number Average molecular weight:

$$M_n = \frac{\sum N_x M_x}{\sum N_x}$$

Weight Average molecular weight:

$$M_w = \frac{\sum W_x M_x}{\sum W_x} \quad \text{because } W_x = N_x M_x, \quad M_w = \frac{\sum N_x M_x^2}{\sum N_x M_x}$$

where  $N_x$  is the number of molecules of polymer with any particular molecular weight,  $M_x$  is the molecular weight of that polymer, and  $W_x$  is the weight of molecules of polymer with any particular molecular weight.

Because  $M_w$  is a square function of the molecular weight of the various polymeric species, it must always be larger than  $M_n$  (unless all of the molecules

are exactly the same molecular weight—in which case, the polymer is called *monodisperse*). The ratio of  $M_w/M_n$  is called the *polydispersity*, which is a term that describes the spread of molecular weights. Polydispersity may be an important function in the properties of the polymer. The high molecular weight polymer molecules have a disproportionately higher effect on viscosity of polymer solutions or melts and on the mechanical properties of the material that contain them. The lower molecular weight molecules contribute to higher solids capability and better flow, but may be deleterious to coating performance. It is often said that the more monodisperse that a polymer is, the better properties the polymer will impart to a coating (1). This concept has been a difficult one to demonstrate, however.

## 2.2 Copolymers

When more than one building block (monomer) is used in polymerization, a copolymer is the product. Copolymerization allows the polymer to be designed for specific physical or application properties. This is like blending ingredients in a formulation and fine tuning the product for optimum performance. As an example, methyl methacrylate is a monomer used in acrylic polymers and provides high hardness. Butyl acrylate is monomer that can be copolymerized with methyl methacrylate. Poly butyl acrylate gives a very soft and flexible polymer. By copolymerizing varying proportions of methyl methacrylate and butyl acrylate, the desired degree of hardness and flexibility can be dialed into the copolymer. This is more effective than blending a polymer of methyl methacrylate and one of butyl acrylate, because the two polymers may not be compatible with each other and may not provide a homogeneous film. In an alkyd resin, a “hard” component is phthalic anhydride. A soft, flexible component is one of the fatty acids used in making the alkyd resin. The amounts of phthalic anhydride and fatty acids can be varied to tune in the desired hardness properties of the coating. The same concept can be used for other properties of the coating, by controlling the amounts and type of the comonomers used in the polymerization. Obviously, the comonomers must react with each other in whatever process is being utilized. Figure 3 shows the chemical structure of the four building blocks previously mentioned. The methyl methacrylate and phthalic units are compact structures leading to hardness and less polymer chain mobility, while the butyl acrylate and fatty acid have longer linear segments that will facilitate more segmental movement in a copolymer and, therefore, provide softer, more flexible behavior.

Aside from the composition of the copolymers, properties can also depend on the polymer architecture associated with the polymer. *Linear polymers* are those that contain monomers joined as shown in Figure 4. Novel properties for polymers and copolymers can be obtained by other architectures, such as graft



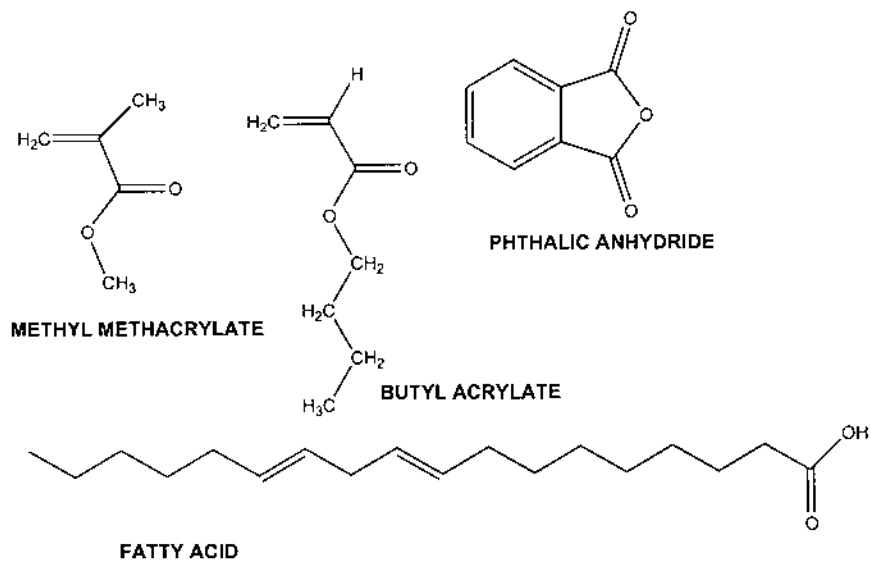

FIG. 3 Structures of methyl methacrylate, phthalic anhydride, butyl acrylate, and fatty acid.

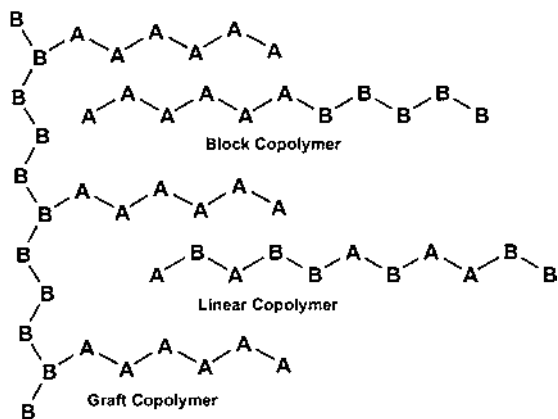

FIG. 4 Polymer architectures.

polymers and block polymers. With these types of structures, the copolymers may take on the properties of the individual segments, rather than a blend of properties that would be observed in random copolymers. An example of the use of this type of architecture in coatings is as dispersants for pigments. One segment of the block or graft copolymer associates with the pigment surface while the other segment associates well with the solvent or other surrounding media (2).

### 2.3 Physical States of Polymeric Materials

The utility of a binder system for coatings is dependent on that binder having the desired properties in the environment in which it functions. This is normally ambient conditions, but it may be important to have specific properties at high or low temperatures. A polymeric material can be characterized by two types of thermal transitions. The temperature range at which it is transformed from a rubbery-type material to a glassy-type material is called the *glass transition temperature* ( $T_g$ ). This is somewhat analogous to the melting point in individual molecules. The glass transition temperature is the temperature range where there is a significant change in the mobility of the segments in a polymeric chain. Above the transition temperature range, segmental mobility is possible and the material acts rubbery. Below that temperature range, the mobility of the chain segments is not possible and the material acts glassy. Because polymers are not monodisperse and there are a variety of inter- and intra-chain interactions, this transition occurs over a range of temperatures rather than at a specific temperature as in a melting/freezing point of small molecules.

Higher molecular weight polymers, like those used in plastic substrates, may also have a thermal transition associated with crystalline regions in the polymer. This transition is called *melting point* ( $T_m$ ) and it is the temperature where the molecular movements of the polymer bonds are reduced enough to allow crystallization to occur. Crystallization requires certain symmetry requirements on the polymer chains and relatively high molecular weight.  $T_m$  occurs at a higher temperature than  $T_g$  and is a much sharper transition. Crystallization is rarely a phenomenon associated with coatings but may often be associated with a plastic substrate. One coating type that is affected by crystallization is chlorinated polyolefins (CPO) that are used as adhesion promoters for thermoplastic polyolefin (TPO) substrates. CPOs are based on polypropylene that has been modified chemically with chlorine and other polar groups. A high degree of chemical modification disrupts the crystallinity of the polypropylene that in turn affects (positively) the compatibility of the CPO with other components, but affects (negatively) its adhesion promoting ability (3). The effect of crystallinity on the properties of the plastic substrate is discussed in more detail in Chapter 3. Figure 5 illustrates  $T_g$  and  $T_m$  transitions and demonstrates the change in volume of a polymer versus temperature.

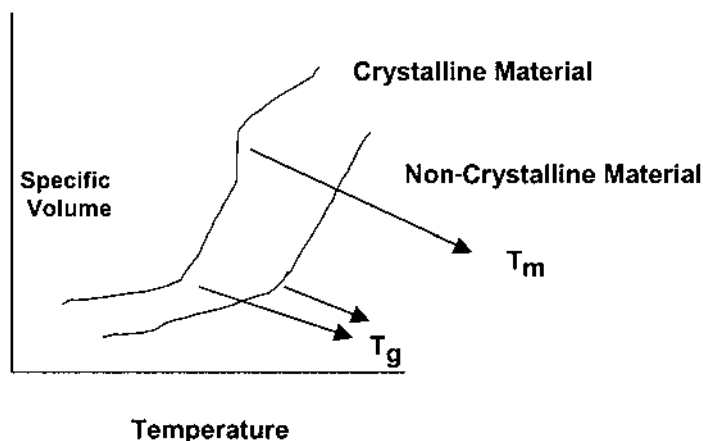

FIG. 5  $T_g$  and  $T_m$  transitions.

#### 2.4 Thermoplastic and Thermosetting Binder Systems

There are two classifications of binder systems, thermoplastic and thermoset. Thermoplastic polymeric materials are those that do not undergo any chemical change during film formation. The film is formed by the evaporation of the solvent (or water). The properties of the film must reside in the properties of the polymer used in the formulation. The only change that occurs over time is a continued loss of volatile material, which will cause the film to continue to harden and become more resistant to damage. Examples of thermoplastic coatings are acrylic lacquers or vinyls. The adhesion promoter for TPO substrates, chlorinated polyolefin, is an example of a thermoplastic polymer.

Thermoset materials, on the other hand, undergo chemical reactions during the film formation (and "curing"). Those chemical reactions may be initiated by heat, radiation sources (UV or other light), or oxidation; or may occur because of the reactivity of materials that are admixed at the time of coating. In the latter case, a catalyst may be added or two (or more) components may be mixed. The coating system then has a limited "pot life." There are many types of thermosetting systems, which will be described later. Air dry alkyd resins are examples of materials that are thermoset by the reaction of the polymeric binder with atmospheric oxygen. An epoxy binder is an example of a two-component and/or catalyzed thermoset.

For polymers to achieve the properties needed for performance coatings, they must achieve a very high molecular weight (4). Figure 6 illustrates the development of physical properties as a function of molecular weight. Typically, the molecular weights must reach 50–100,000 to achieve good performance.

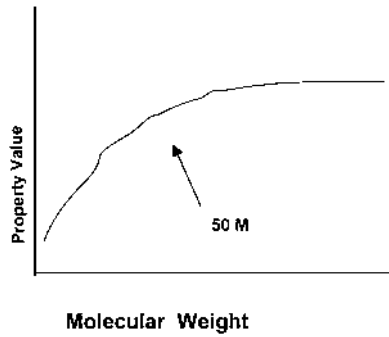

Fig. 6 Development of physical properties as a function of molecular weight.

In a thermoplastic system, the polymer molecular weight must exist as the coating is applied. Because high molecular weight polymers have very high viscosities, only low concentrations are possible for most application techniques. Figure 7 illustrates the behavior of viscosity versus molecular weight. When viewing both Figures 6 and 7, it is apparent that there is a limited working window where application requirements and performance properties can be satisfied. There are several solutions to this problem. The polymers can be prepared or processed in a dispersed form. (An emulsion is a dispersion of polymeric particles in water.) When dispersed, there is less interpolymeric interaction and higher concentrations of polymer can be handled at lower viscosities. When polymers are applied in a dispersed form, however, it is necessary to formulate

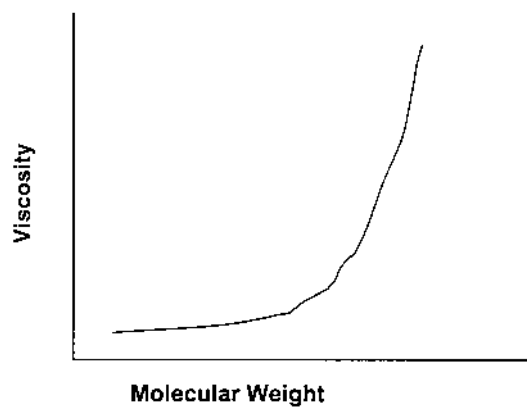
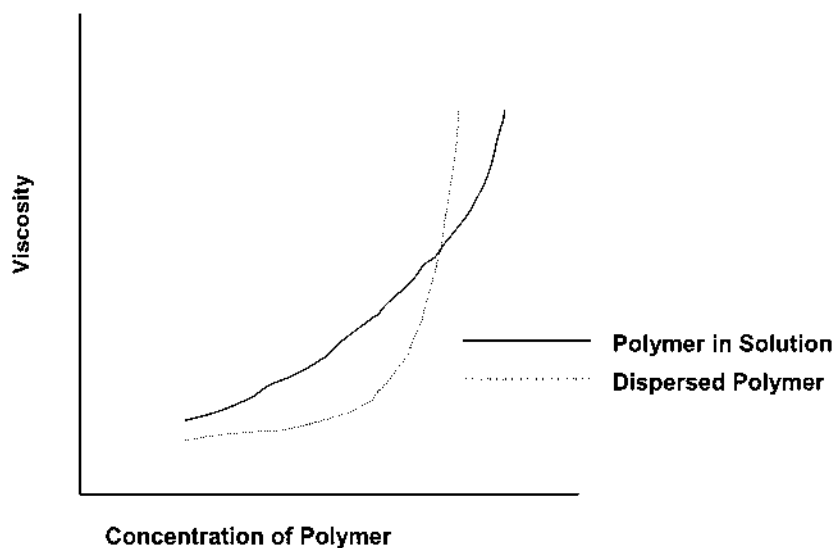

Fig. 7 Behavior of viscosity versus molecular weight.

them in a manner that allows them to coalesce into a coherent film after liquid is applied. Figure 8 demonstrates, schematically, the difference in viscosity between solutions and dispersions as a function of concentration.

**2.5 Polymer Architecture**

Polymer architecture is a term applied to describe forms of the polymer molecules. It describes a spatial form of the polymer molecules. Examples of polymer architecture already discussed are dispersed polymers versus solution polymers and block and graft copolymers. Polymer architecture also encompasses the form of segments built into the polymer backbone, such as rigid segments or flexibilizing segments. Branching, either as a random phenomena or as a particularly ordered structure, is a type of architecture that can be built into polymer molecules. Branching can lead to a lowering of polymer/polymer interactions and it can lead as a precursor to more network formation in a thermosetting system. When structural features of the polymer molecule are something more than a random joining of the segments (monomer units) making up the polymer, a form of architecture is developed. Star polymers (where a number of polymer chains radiate from a center point) and dendrimers (where a highly branched, but well-ordered structure is developed) are examples of polymer architecture that will lead to higher molecular weight at lower solution viscosity.



**FIG. 8** Difference in viscosity between solutions and dispersions as a function of concentration.

If stars or dendrimers contain functional groups on the terminals of the arms, they react much faster than linear polymers to form thermoset coatings. Figure 9 shows schematic drawings of linear, branched, star, and hyperbranched (or dendritic) polymers. (Dendritic polymers are special hyperbranched materials with very ordered structures.)

## 2.6 Solvency

An important consideration for formulating polymeric materials into coatings is their solvency or compatability. The physical forces that are important in solvency include dispersion (van der Waals) forces, polar components, and hydrogen bonding. A simplified, but often applicable notion is that "like likes like." Polymers that have high concentrations of polar moieties (amino, imino, hydroxyl, carbonyl, and carboxyl groups) usually require solvents that are also highly polar (alcohols, ketones, esters, etc.). Polymers that have high concentrations of hydrocarbon segments will be soluble in aliphatic and aromatic solvents (such as xylene, toluene, mineral spirits, and napthas). Very nonpolar polymers may be difficult to solubilize in alcohols or ketone solvents. The same notion applies to other components of a formulated coating.

The molecular weight of the polymers will also affect the solvency. The higher the molecular weight, the less compatible a polymer will be in a variety of solvents and the less compatible it will be with other polymers. This is a

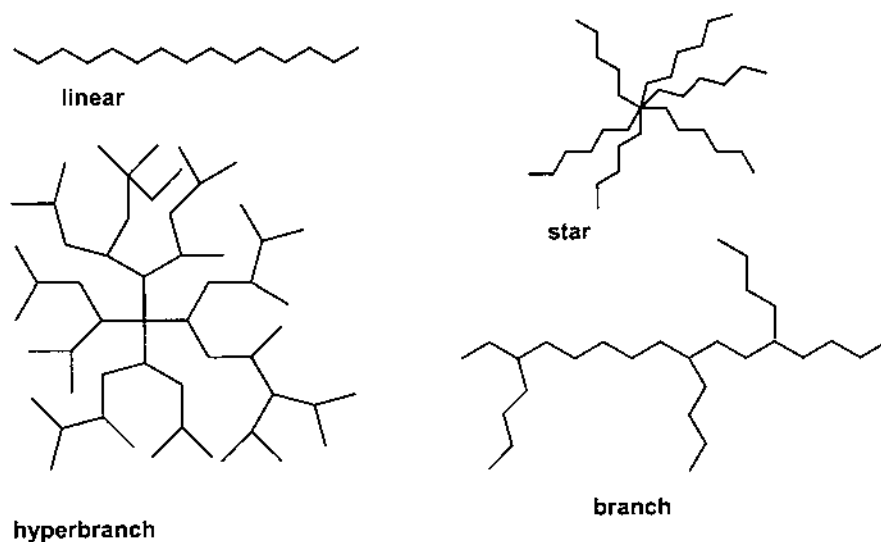

FIG. 9 Polymer architecture.

result of the inability of the large molecules to move into positions where mutually attractive forces from solvent or other binder polymers can displace the forces within the large polymer molecules. In coatings, it is frequently necessary to compromise the optimum properties available from higher molecular weights in order to achieve compatibility. Lack of compatibility will degrade appearance and mechanical properties. Often, smaller molecules—plasticizers or reactive diluents—can compatibilize a binder system. In these cases, the boundary between a solvent and a reactive diluent or plasticizer is blurred. The retention of those molecules may depend on time after the coating application or the temperature of cure.

**2.7 Functionality**

Functional groups in coatings binders are chemical moieties that are present and can participate in chemical reactions during the coating process. In thermosetting systems, they are the reactive handles that will provide the sites for cross-linking (curing) reactions to occur. In both thermoplastic and thermosetting systems, functional groups may be present to allow some other chemical or physical transformation to occur (neutralization of acid groups for putting resins into water, polar groups for adhesion purposes, groups that will help disperse pigments, etc.). Examples of functional groups are hydroxyl groups, amino groups, carboxyl groups, epoxy groups, and isocyanate groups. Polymers and resins are often characterized by some quantitative description of this functionality. Table 1 gives examples of common functional groups in coatings and the property often used to describe the concentration of these groups in the polymer (acid number, hydroxyl number, percent isocyanate, percent hydroxyl). It is most helpful for the formulator when these characterizations are described as weight of polymer per functional group (equivalent weight). Unfortunately, this is not always the case and a formulator must make an arithmetic conversion to convert the descriptor to one that can be used in formulation.

**TABLE 1** Functional Groups

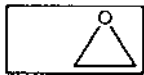
| Structure  | Functional group  | Term describing functionality            |
|------------|---|--|
| Carboxyl   | —COOH   | Acid number                              |
| Hydroxyl   | —OH   | Hydroxyl number                          |
| Amine      | —NH <sub>2</sub>  | Amine number<br>Amine equivalent weight  |
| Epoxy      |  | % Epoxy<br>Epoxy equivalent weight (EEW) |
| Isocyanate | —N=C=O  | % Isocyanate                             |

### 3 Polymer Types

In the following subsections, the descriptions of polymers will be divided into two types—primary binders and crosslinkers. This division applies only to thermosetting systems. Thermoplastic systems consist only of a primary binder, because no crosslinking reaction is designed to occur upon film formation. The distinction between these two types may not always be obvious, but conventionally, the higher molecular weight component of a thermosetting system would be the primary binder and the lower molecular weight component—often with higher concentration of functional groups—will be considered the crosslinker.

#### 3.1 Acrylic Resins

The term *acrylic* applies to a family of copolymers of monomers that are polymerized by a chain growth mechanism. Most often, the mechanism of polymerization is by free radical initiation. Other mechanisms of polymerization, such as ionic and group transfer polymerization, are possible but will not be discussed in this publication. For a description of other polymerization mechanisms, polymer textbooks are available (5,6). Technically, acrylic monomers are derivatives of acrylic or methacrylic acid. These derivatives are nonfunctional esters (methyl methacrylate, butyl acrylate, etc.), amides (acrylamide), nitrile (acrylonitrile), and esters that contain functional groups (hydroxyethyl acrylate, glycidyl methacrylate, dimethylaminoethyl acrylate). Other monomers that are not acrylic derivatives are often included as components of acrylic resins because they are readily copolymerized with the acrylic derivatives. Styrene is often used in significant quantities in acrylic copolymers.

Acrylic resins are most often used in coatings designed to have excellent photooxidative durability. The ease of copolymerization of a large number of functional and nonfunctional monomers allows for the design of many physical properties. Hardness and softness, refractive index, chemical and humidity resistance, degree of durability, degree of crosslinking, and crosslink type are easily designed into an acrylic copolymer. Inherently, however, acrylic copolymers are not very flexible. It has been difficult to formulate acrylic resins into coatings that require a high degree of flexibility and impact resistance and still have other properties that are acceptable for fitness of use.

The lack of flexibility in acrylic resins is due to the restricted degree of movement of the segments of the polymer chain. The nature of acrylic monomers is that copolymers have bulky groups attached to the polymer backbone on alternate carbon atoms. Methacrylate copolymer units place two bulky side groups on the polymer backbone, further restricting the motion that the polymer molecules can undergo. Table 2 shows common units on an acrylic copolymer backbone. The degree to which an acrylic copolymer is hard, soft, flexible, or rigid is an additive function of the comonomers that constitute the polymer



**TABLE 2** Monomers for Acrylic Copolymers

| Monomer                    | Structure                | $T_g$ (°C) | Feature                                   |
|----------------------------|--------------------------|------------|---|
| Methyl methacrylate        | $R_1$<br>CH <sub>3</sub> | 105        | Hardness, durability, hydrophilicity      |
| Butyl methacrylate         | CH <sub>3</sub>          | 20         | Control feature (starting point)          |
| Ethylhexyl methacrylate    | CH <sub>3</sub>          | -10        | Increased solubility, hydrophobicity      |
| Butyl acrylate             | H                        | -54        | Flexibility, low $T_g$                    |
| Ethylhexyl acrylate        | H                        | -50        | Flexibility, low $T_g$ , hydrophobicity   |
| Styrene                    | H                        | 100        | Gloss, hardness, low cost                 |
| Acrylamide                 | H                        | 165        | Adhesion, pigment wetting                 |
| Acrylonitrile              | H                        | 125        | Solvent resistance, insolubility          |
| Acrylic Acid               | H                        | 106        | Adhesion, catalysis, water solubility     |
| Hydroxyethyl acrylate      | H                        | -15        | Reactivity for crosslinking               |
| Hydroxypropyl methacrylate | CH <sub>3</sub>          | 76         | Reactivity for crosslinking, higher $T_g$ |
| Glycidyl methacrylate      | CH <sub>3</sub>          | 46         | Reactivity for crosslinking               |

backbone. These properties are governed to a large degree by two basic properties—the  $T_g$  and the crosslink density (in a thermosetting system). The  $T_g$  is governed by the bulkiness of the pendant groups on the copolymer chain, by plasticizing effects of the pendant groups, and by polar and hydrogen bonding interactions that may arise from the polar nature of the pendant groups. The  $T_g$  of an acrylic copolymer (and others) is an additive function of the comonomers. The  $T_g$  of the polymer can be predicted by the Fox Equation (7) (see following text). This equation utilizes the  $T_g$  of the homopolymer of each of the comonomers and sums a weighted average of the comonomers.

Fox Equation:

$$100/T_g = \text{wt.\% monomer A}/T_{g_A} + \text{wt.\% monomer B}/T_{g_B} + \dots \text{wt.\% monomer X}/T_{g_X}$$

$T_g$ s are expressed in degrees Kelvin. ( $T_{g_X}$  is the  $T_g$  of a homopolymer of the monomer X.)

Table 2 also illustrates the  $T_g$  contributions of common monomers and some of the properties that each monomer brings to an acrylic copolymer.

In acrylic copolymers, as in other polymers, the size of the polymer (molecular weight) has an effect on the properties of that material. This is also true of the  $T_g$ . In the consideration of  $T_g$  in the design of the copolymer, this must be considered. The  $T_g$  rises until a molecular weight is large enough that further interchain interactions do not increasingly effect the ability of the chain segmental motion to occur. This is sometimes called the chain entanglement molecular weight (8). Figure 10 demonstrates the effect of molecular weight on the  $T_g$  of a copolymer. The  $T_g$  predicted by the Fox Equation is that which is at or above this entanglement point.

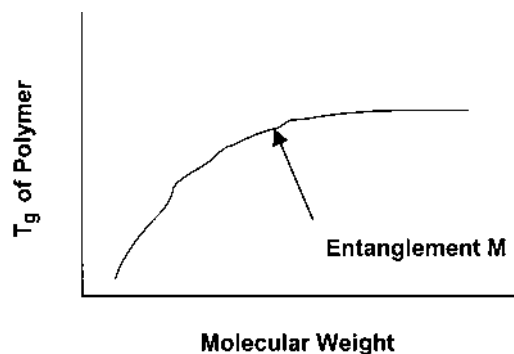

FIG. 10 Effect of molecular weight on the  $T_g$  of a copolymer.

Acrylic lacquers are high molecular weight acrylic copolymers. Their film formation is accomplished by the evaporation of the solvent(s) in the formulation. Emulsions (water based) of acrylic copolymers are also easily prepared and can provide lacquer-like properties. The properties of lacquers are governed by their molecular weight, their  $T_g$  (similar to film formation temperatures), and any chemical moieties that may affect the interaction of the polymer with the surfaces it will coat or the pigments that are present (e.g., adhesion and dispersion characteristics). There is no dependence on chemical reactions occurring to further enhance the coating properties. Often plasticizers are used with acrylic lacquers to facilitate the application of the coating and perhaps to influence the hardness or flexibility of the final coating.

Thermosetting acrylic binder systems utilize copolymers of functional and nonfunctional acrylic (or similar) monomers. The functional monomers are incorporated for reactivity with crosslinkers. The most common functional monomer for reactions is the hydroxyl group. The hydroxyl groups on the acrylic copolymers react with melamine and urea resins (amino resins) and with polyisocyanates. These reactions are shown in Figure 11. The reaction of hydroxy functional polymers with amino resins require acid catalysis and heat. The reaction with polyisocyanates can occur at room temperature as well as at higher temperatures. A number of materials will catalyze the hydroxyl/isocyanate reaction (organotin compounds, acids, amines, metal salts, etc.)(9).

In both types of thermosetting systems, physical and economic properties are adjusted by the balance of the comonomers. Examples of cost/property compromises are shown below, although the cost of various building blocks will vary over time due to cost of petrochemicals and the scale at which each material is produced.

|                                     |        |
|-------------------------------------|--------|
| Styrene                             | 1x     |
| Nonfunctional acrylic monomers      | 2x     |
| Nonfunctional methacrylate monomers | 2.5–3x |
| Hydroxyl acrylate and methacrylates | 3x–4x  |
| Amino resins                        | 3x–4x  |
| Aliphatic polyisocyanates           | 8–10x  |

### Examples of Cost/Performance Compromises

#### 3.1.1 Photooxidative Durability

Styrene contributes hardness and high gloss (due to a high refractive index) to coating binders. Styrene, being an aromatic chemical, absorbs UV light that can activate some copolymer bonds to break. The aromatic moiety can also stabilize free radicals that are generated and lead to degradation reactions. This limits the amount of the low-cost styrene that can be incorporated into a coating that

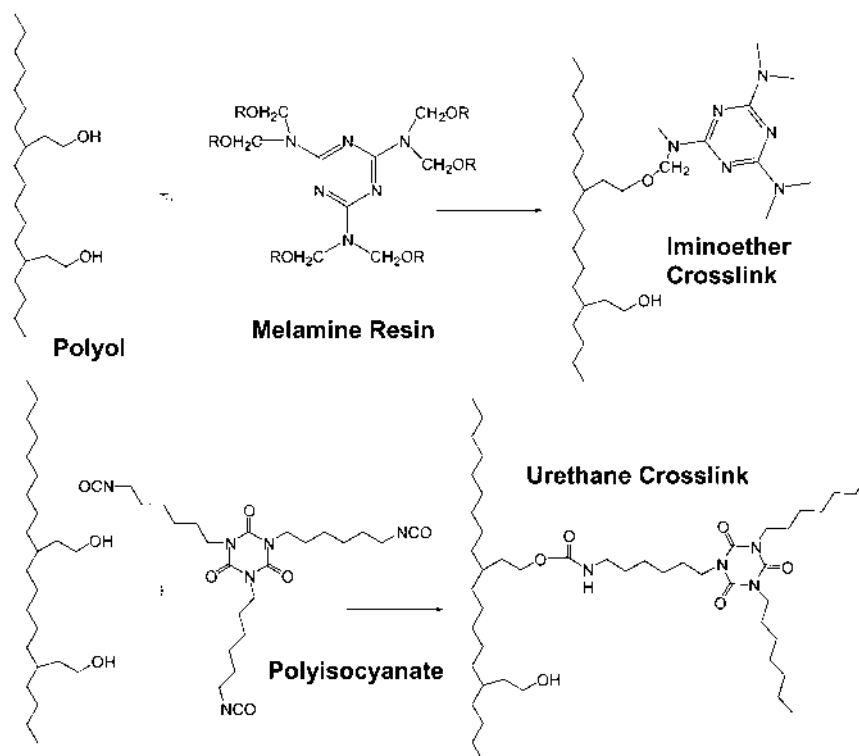

FIG. 11 Reactions of hydroxyl groups on acrylic copolymers with melamine and urea resins and with polyisocyanates.

is designed for exterior durability. Typically, the total level of styrene that is incorporated into a durable coating binder is about 15 weight percent of the combined binder system in a thermosetting system.

Hydroxyl functional acrylics that are crosslinked with amino resins are less durable than those crosslinked with the much more expensive aliphatic polyisocyanates (other formulating factors being equal). The crosslink formed is liable to hydrolytic assisted photooxidation (10).

### 3.1.2 Mar-and-Scratch Resistance

One of the most important characteristics of a thermosetting coating to achieve good mar-and-scratch resistance is the crosslink density of the coating (11,12). Crosslink density is a function of the amount of functionality and the degree of reaction of that functionality. The preceding cost chart shows that the functional

monomers cost more than the nonfunctional monomers and the crosslinkers are also more expensive. In this case, performance can be achieved at increased material cost.

### 3.1.3 Environmental Etch Resistance

The crosslink formed by amino resins with hydroxyl functional acrylic copolymers is sensitive to acid-catalyzed hydrolytic degradation (13,14). The urethane crosslink formed by the reaction of hydroxyl functional acrylics and polyisocyanates is much more stable to this condition (15). This means that aiming for improved environmental resistance requires the more expensive polyisocyanate crosslinkers. Other crosslinking mechanisms of functional acrylics and crosslinkers will provide a better compromise of cost and etch performance, but these are often accompanied by other compromises.

## Other Crosslinking Mechanisms for Thermosetting Acrylic Coatings

### 3.1.4 Carbamate/Melamine

In the second half of the 1990s, the reaction of amino resins with primary and secondary carbamate functionality was introduced into automotive coatings and coatings for plastics (16–18). This curing reaction reportedly brings the advantage of a cure with amino resins that gives a more hydrolytically stable bond than the hydroxyl/amino resin bonding (Fig. 12). This curing reaction requires somewhat more rigorous conditions than the hydroxyl/amino cure, but falls within the capabilities of many industrial coating processes. Because amino resins with their high concentration of functionality are used, a good balance of environmental etch resistance and mar resistance may be achievable.

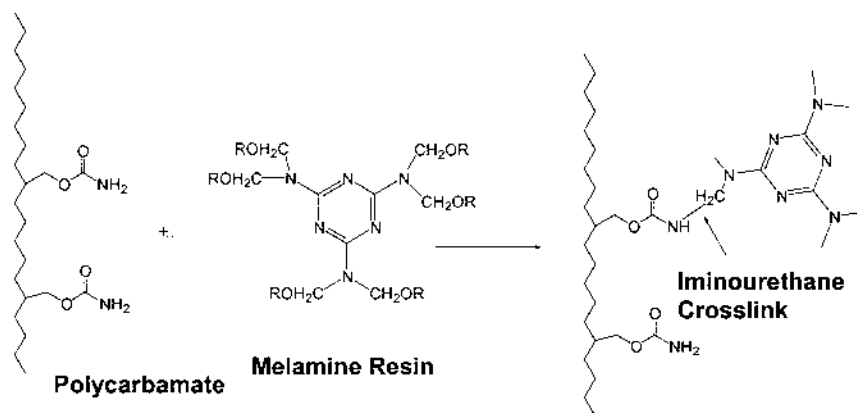
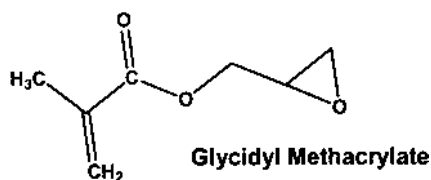

FIG. 12 Curing reaction.

## 3.1.5 Epoxy/Acid

The curing of epoxy functional acrylics with polycarboxylic acids has been exploited for powder coatings and automotive clearcoats (19,20). This type of chemistry is difficult to apply for many plastic substrates due to a combination of high curing temperature when uncatalyzed and of poor stability (of the packaged coating) when catalyzed. Yellowing has also been a problem in catalyzed epoxy/acid curing (21). The ester bonds formed by the cure reaction (Fig. 13) are very stable to environmental hydrolysis and provide good etch resistant coatings. It is difficult to achieve very high mar resistance with epoxy/acid curing as the nature of the polyacid curing agents yields lower crosslink density and the rigorous cure requirements often lead to some degree of undercuring. The most readily available acrylic monomer with epoxy functionality is glycidyl methacrylate



methacrylate, which has a high  $T_g$  component. This high  $T_g$  tendency restricts the concentration of functional groups in a coating aimed at a flexible substrate. Epoxy/acid curing is often accompanied by auxiliary crosslinking to bolster the properties. This is readily done, because the cure reaction between epoxy and acid yields a hydroxyl bond that can be cured with the crosslinking agents previously described (see Fig. 11).

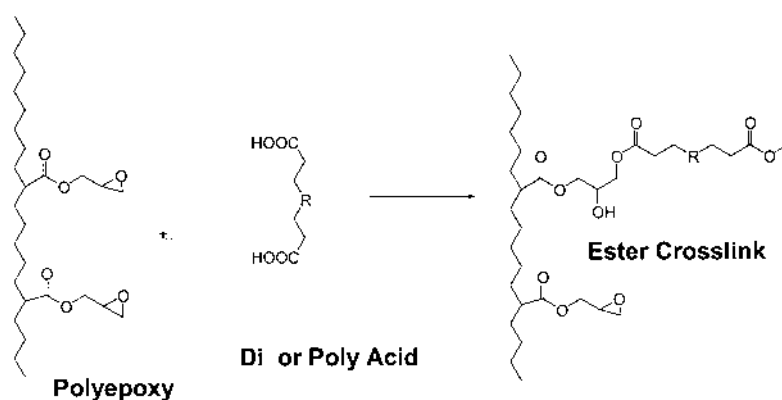
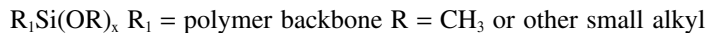

FIG. 13 Ester bonds formed by the cure reaction.

3.1.6 Silane

There are a number of ways to introduce organosilane functionality onto polymer backbones. Silane functionality for coatings exists in the form shown in the following text.



In acrylic resins, this is accomplished by copolymerizing an acrylate or methacrylate containing organosilane. The most readily available of these is  $\gamma$ -trimethoxysilylpropyl methacrylate (TMSPM). The advantages of silane func-

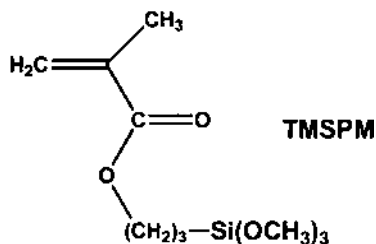

tionality is the high degree of flexibility and hydrolytic stability in the Si–O–C or Si–O–Si bonds that are formed in the curing reaction. The curing reaction can be initiated by moisture or by reactions with hydroxyl functional crosslinkers as shown in Figure 14 (22,23). In moisture cure reactions, the alkoxy silane

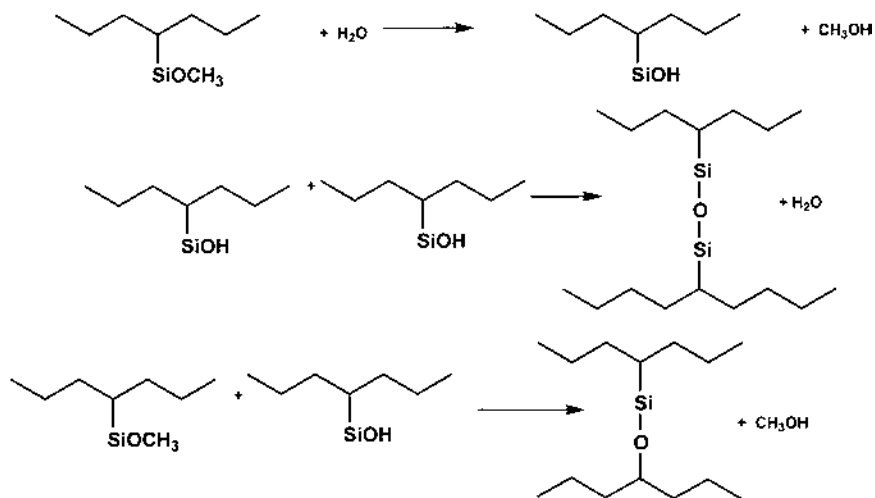

FIG. 14 Hydroxyl functional crosslinkers.

functional group reacts first with water to form a silanol (SiOH) group. This occurs both with acid and base catalysis. The silanol group then self-reacts to form a siloxane bond (Si–O–Si). The siloxane bond provides a great deal of flexibility to a crosslink structure and is very resistant to hydrolysis. Silane functionality also can provide a high crosslink density due to the multiple number of alkoxy groups attached, all of which can participate in crosslinking reactions if the conditions are rigorous enough (catalysis, availability of moisture, cure temperature). The disadvantages of organosilane functionality are high cost and softness (low  $T_g$ ) that is inherent when the very flexible siloxane bonds are present.

### 3.2 Polyester Binders

High-performance coatings for plastic substrates are often formulated with polyester resins that are then crosslinked with materials similar to those described for acrylic resins. Polyesters are prepared by a step growth polymerization mechanism from polycarboxylic acids (or their anhydrides) and polyols. Just as in acrylic binders, a wide variety of properties can be formulated by the choice of the polyacids and polyols. As a class, polyesters are often not thought of as a super-durable building block, but polyesters can be very durable. Polyesters also are more easily designed to have better flexibility and impact resistance than acrylic resins. In acrylic resins, the polymer backbone is always carbon-to-carbon bonding with some bulky substituent on that backbone. This configuration restricts the ability of that polymer molecule to rotate and yield more flexible materials. In polyesters, the polymer backbone that has a series of ester linkages can be designed to have a significant amount of rotational movement and provide materials with greater flexibility. The carbon-carbon backbone bonding of an acrylic resin is not as susceptible to chemical degradation reactions as a polyester backbone that consists of a string of ester linkages, which are capable of being degraded by chemical attack.

Figure 15 shows a number of commonly used polyols and polycarboxylic acids used in making polyesters for coating purposes. (In polyesterifications, anhydrides behave like difunctional acids.) Like the acrylic monomers, the economics of these building blocks are often associated with the production volume of the material. Often it is the noncoating uses of the monomeric materials that govern this cost. The aromatic acids (phthalic and isophthalic) provide rigid linkages with properties of hardness and stiffness. The aliphatic acids like adipic or azelaic, contribute sequences of methylene ( $\text{CH}_2$ ) linkages that provide flexibility. As with acrylic monomeric materials, the aromatic containing building blocks can absorb some of the wavelengths of sunlight (and even more of the wavelengths found in accelerated weathering testers) making the polyester more susceptible to photooxidative degradation reactions and therefore less durable. For this reason, aliphatic polyesters are more widely used by today's coatings for plastic formulators.



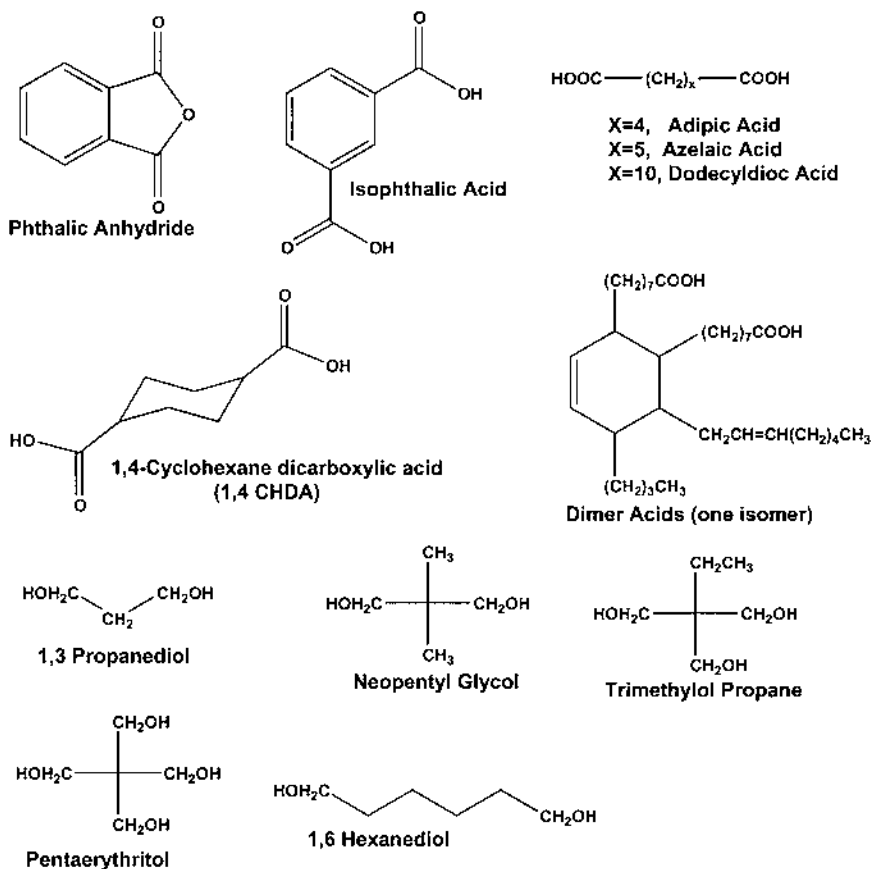

FIG. 15 Some commonly used polyols and polycarboxylic acids used in making polyesters for coating purposes.

The utilization of polyacids or polyols that place cycloaliphatic rings along the polyester backbone is thought to provide a better balance of hardness and flexibility or impact resistance than is attainable otherwise (24). Examples of this type of monomer is cyclohexanedimethanol (CHDM) and 1,4 cyclohexanedicarboxylic acid (CHDA). This property may be due to the ability of the cyclohexane ring to change conformations (chair to boat) as a mechanism for absorbing energy without causing bond breakage.

Branching of polyesters is accomplished by using polyols with functionality greater than two (e.g., trimethylol propane [TMP] or pentaerythritol [PE]). Branching of polymeric materials is another mechanism for introducing the po-

tential for flexibility and impact resistance. The branches can prevent some polymer chain/polymer chain interactions that may cause stiffening. Branching may provide higher crosslink density to thermosetting polyesters. This is an important property for mar and scratch resistance and for resistance to attack by chemical agents and moisture. The amount of monomeric building blocks that have functionality greater than two is limited in the step growth polymerization process for preparing polyesters. When the average functionality of the monomers is too high, the polyester will gel in preparation. Discussions of this phenomena is found in polymer textbooks (25).

### 3.3 Polyurethane Binders

Polyurethanes are prepared in step-growth polymerization processes similar to that used for preparing polyesters. In fact, many polyurethane materials are hybrids of ester linkages and urethane linkages. If a polyisocyanate is substituted for the polycarboxylic acid shown in Figure 2, the result is a polyurethane. The urethane linkage is obtained by the reaction of an alcohol with an isocyanate. (The urethane linkage is also known as a secondary carbamate.)

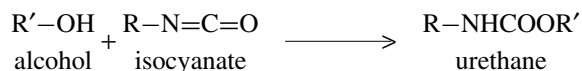

Figure 16 illustrates polyisocyanates that are commonly used to prepare polyurethanes. The aromatic polyisocyanates are significantly less expensive than the aliphatic types. Again, this is due to the larger production volumes of

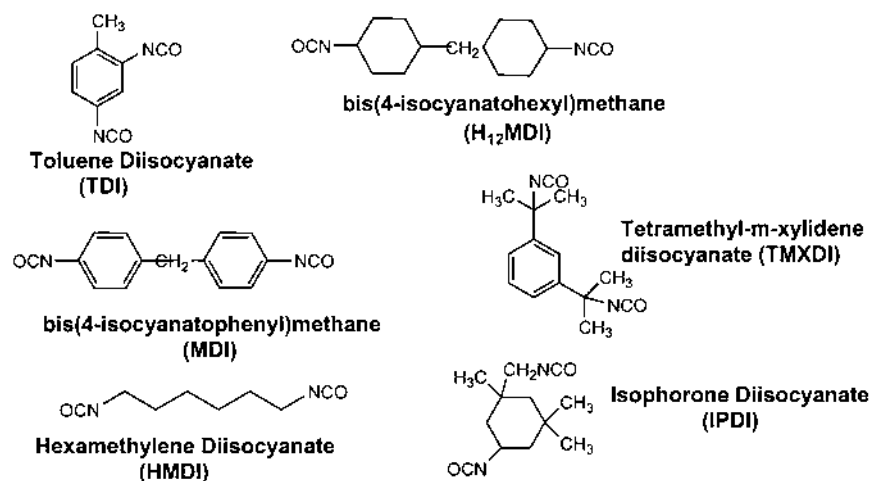

Fig. 16 Some polyisocyanates commonly used to prepare polyurethanes.

the aromatic materials that find use in foams and other structural applications. Aromatic urethanes not only suffer from poorer durability than the aliphatic types, similar to aromatic polyesters and styrene-containing acrylics, but they are known to yellow severely upon exposure to sunlight. In coatings, aromatic urethane binders are limited to use as primers and undercoats. Even in these applications, a user must be careful to protect these undercoats from exposure to UV light either with sufficient hiding pigmentation or with UV-absorbing additives.

Urethane linkages in coatings provide toughness and flexibility to the binders. As discussed in the Environmental Etch Resistance section (Sec. 3.1.3), they are also more resistant to hydrolytic events than ester linkages and can provide better chemical-resistance properties. The toughness property is explained by the formation of interpolymer hydrogen bonding in the coating. The hydrogen bond between the imino (NH) and the carbonyl (C = O) can be broken under the stress of impact, absorbing energy, and then reforming after the stress event (26). Figure 17 demonstrates this type of hydrogen bonding. The polar nature of the urethane bond also accounts for chemical resistance properties versus oily material exposure. Historically, alkyd coatings have been modified by reactions with polyisocyanates to give them better resistance to gasoline and oils.

An important class of polyurethanes are waterborne polyurethane dispersions (PUD) (27–29). The PUD has been a component of “soft touch” coatings and finds significant usage in other waterborne coatings as a component that adds toughness and cohesive strength to the coating. The difference between PUDs and other polyurethane resins described above is that ionizable groups (usually carboxyl) are incorporated on the polyurethane backbone. This allows the polymer to be dispersed in water after neutralization of those carboxyl groups by amines. As previously discussed, the properties of the PUD can be varied substantially depending on the structure of the polyol and diisocyanate materials used to prepare them. Further discussion of the ability to be handled

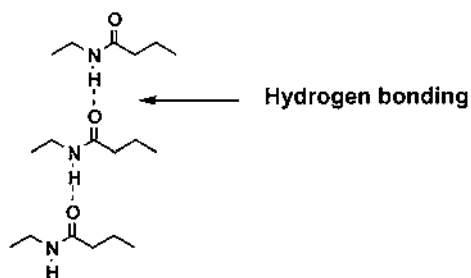

FIG. 17 Hydrogen bonding.

in water and the tradeoffs that result by making polymers useable in aqueous coatings will be described in the Polymers for Waterborne Coatings Section (Sec. 5.2).

### 3.4 Polyether Modifications of Polyesters and Polyurethanes

In order to accommodate the need for flexibility (or lower cost) in coatings for some plastic substrates, polyols with internal ether linkages can be utilized. In this case, a carbon-oxygen-carbon (COC) linkage replaces a CCC linkage. The COC bond is significantly more flexible than the CCC bond. Series of polyether polyols are easily prepared from ethylene oxide and propylene oxide (and other cyclic ethers), which makes them very economical and provides a large number of materials for dialing in a desired balance of hardness and flexibility. Again, the low cost of these materials is from their high production volumes due to their use in plastic materials. Figure 18 shows the synthesis of polyether polyols.

The disadvantage of polyethers is their poor photooxidative durability. A carbon-hydrogen bond adjacent to the ether linkage is attacked by free radical sources to yield peroxides that subsequently cause backbone scission and/or lead to moieties in the coating (like carbonyl groups) that can cause more degradation or color. As with the aromatic urethane linkages, polyether linkages are often only used in primers or other applications where photooxidative durability is not a primary property.

The polyethers of ethylene oxide (ethoxylates) can be used to provide hydrophilicity to a polymer backbone and consequently water solubility or dispersibility. This is a desirable property if waterborne coatings are required, but does lead to some degree of water or humidity sensitivity of the coating.

### 3.5 Crosslinking Binders

In this section, materials with a high concentration of functionality, which are used to yield thermosetting coatings, are discussed. Most commonly, materials

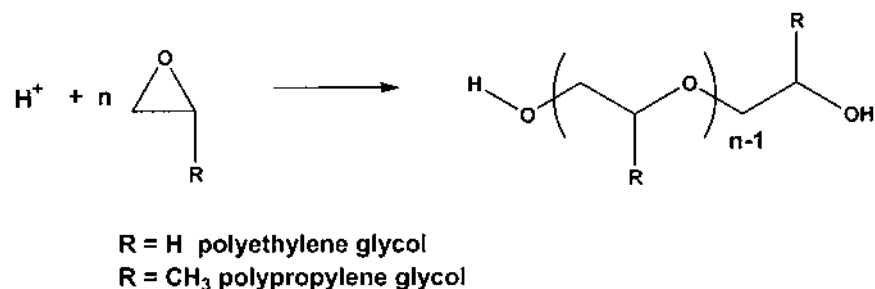

FIG. 18 Synthesis of polyether polyols.

with many functional groups and lower molecular weight are considered the crosslinkers (versus the primary binder). Here, we will discuss two materials of this type—polyisocyanates and amino resins. They are used to react with acrylic resins, polyester resins, and other polymeric backbones containing active hydrogens, and form useful coatings.

### 3.5.1 Polyisocyanates

Polyisocyanates are versatile crosslinkers for plastics coatings with favorable features of low-temperature cure, chemical resistant bonding, and flexibility. Polyisocyanates are more expensive than amino resin crosslinkers, often do not provide good mar-and-scratch resistance, and need very careful handling due to hygiene concerns. Aliphatic polyisocyanates yield very durable, non-yellowing coatings when formulated correctly. Coatings crosslinked with aromatic polyisocyanates, which are more available and less expensive, will have poor durability and yellowing if exposed to sunlight. Commonly used polyisocyanates are shown in Figure 19.

Polyisocyanates are reactive with binders that contain active hydrogens (hydroxyl and amino), are self-reactive, and will react with ambient moisture to give cured coatings. The most common reactions for curing coatings are shown in Figure 20.

Because of the reactive nature of isocyanate groups with the mentioned functional groups, polyisocyanates can be formulated to react under a wide variety of cure conditions. Many substances catalyze these reactions. Common catalysts are organotin compounds, other metallic salts, amines, and acids. This breadth of catalytic species can also introduce problems, because catalysts may be unknowingly introduced from other components of a formulation or even as contaminants of other formulating materials.

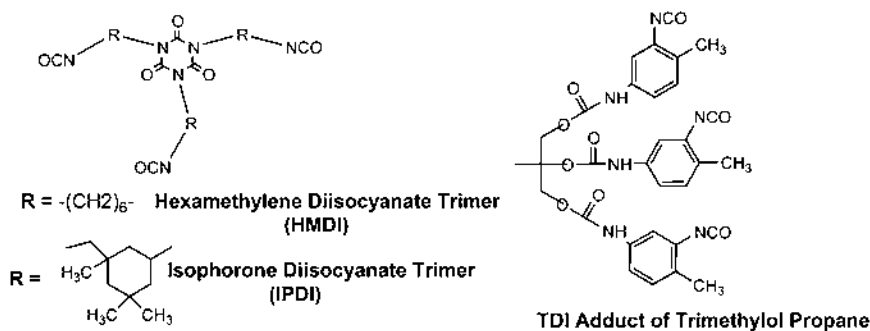

FIG. 19 Some commonly used polyisocyanates.

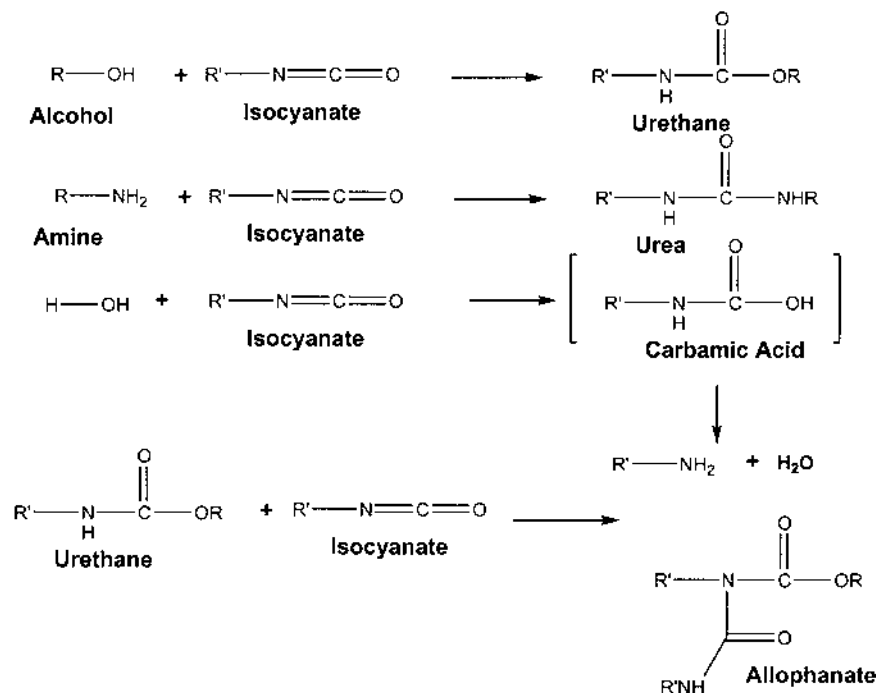

FIG. 20 Cure reactions with isocyanates.

The reactivity of polyisocyanates, described previously, often requires that the coating system be provided in multicomponents that are mixed just prior to use. It will also require protection of the isocyanate component from moisture during storage and handling. As a result, many coatings utilizing polyisocyanate crosslinkers are known as “2K” coatings. (The “K” comes from the German “komponent.”) Because the components, after mixing, will react under ambient conditions, there will be a limited time that the mixture is usable. The usable lifetime, which may vary depending on the definition of usability, is known as the “pot life.” After exceeding the pot life of the mixture, it may be too viscous for application and performance properties of the coating will not match up to fresh mixes—or both.

Along with the polyisocyanates that are commercially available, isocyanate containing prepolymers can be prepared to provide even wider formulating and handling latitude. These prepolymers are often based on monomeric or poly-

meric polyols that have been reacted with diisocyanates to provide terminal, reactive crosslinking sites (Fig. 21).

For durable polyurethane coatings, HDI trimer and IPDI trimer are most commonly used. The trimers are formed by controlled reaction of the diisocyanates. The trimerization process yields higher viscosity, but introduces functionality greater than two, that is necessary to form good crosslinked films. The trimerization also removes volatile isocyanates and yields a material which can be handled with practical protection schemes. (As with any chemical substance, a user must understand the personal protection necessary for handling.) This trimerization process will also generate higher molecular weight oligomers that can affect the performance properties and the application solids (and related solvent emissions). At some higher cost, the manufacturers of these materials can remove these higher molecular weight components. Under different conditions the diisocyanates can be dimerized (called uretdiones), producing coatings with a lower viscosity and a lower degree of crosslinking. Mixtures of dimers and trimers are available for higher solids coatings.

HDI trimer will provide a softer, more flexible coating than IPDI trimer. This is due to the structure that has a six carbon linear moiety separating the center of the trimer with the reactive isocyanate group. The IPDI structure introduces a more rigid cycloaliphatic ring that yields a harder coating with less ability to flex. The isocyanate associated with IPDI is somewhat slower reacting than that associated with HDI and may require higher curing temperatures or more catalyst. Because the IPDI structure introduces inherent hardness, it is necessary to check a coating that is thought to be cured for some other measure of cure than hardness or dry time.

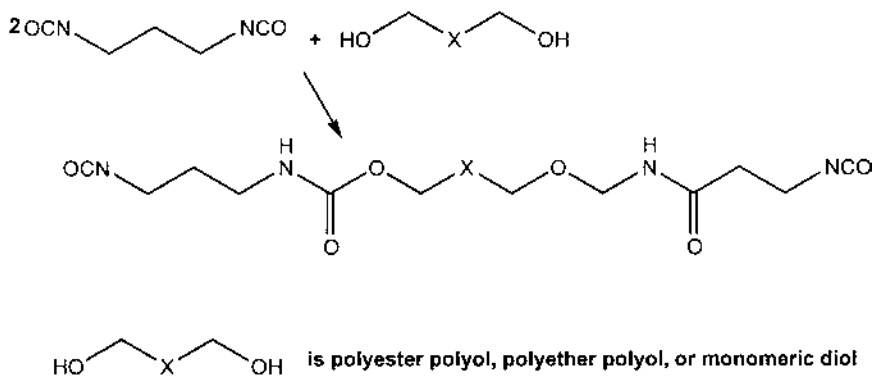

FIG. 21 Polyurethane prepolymer preparation.

### 3.5.2 Amino Resin Crosslinkers

Amino resins are formed from amino-containing (NH<sub>2</sub>) chemicals where the amino group is adjacent to an electron-withdrawing portion of a molecule. In this configuration, the amino groups are not nearly as basic as amines. These amino groups are reacted with formaldehyde to yield reactive methylol groups (Fig. 22). The most commonly used precursors for amino resin crosslinkers are urea (22a) and melamine (22b). When reacted with formaldehyde they produce polyfunctional reactants that have three to six (or more) reactive sites on a fairly small molecule. The methylol functional crosslinkers are further modified by the reaction with alcohols to generate alkoxymethyl derivatives (22c). This modification renders the amino resins more storage stable (both with themselves and in formulations) and more soluble and compatible with the polymeric materials that they will be formulated with in a coating. The primary reactions shown in this section are accompanied by side reactions involving the condensation of the amino crosslinkers with themselves and the degree to which any of the reactions take place can be controlled by the conditions of the reactions and the mole ratios of the reactants. This results in families of amino resin crosslinkers with ranges of reactivity, solubility, and stability.

The amino resins can react with several functionalities on the “main binder resins” such as hydroxyl, amide, carboxyl, and urethane (or carbamate). Most commonly, the binder resins are hydroxyl functional acrylics, polyesters, or modifications of these. Recently, there has been an increase in product offerings and literature references to urethane or carbamate functional resins being paired with amino resins (16–18). The curing reactions require acid catalysis and heat. There is a significant variety of reactivities (and therefore curing temperatures) possible with amino resins, but the lower temperature cure materials

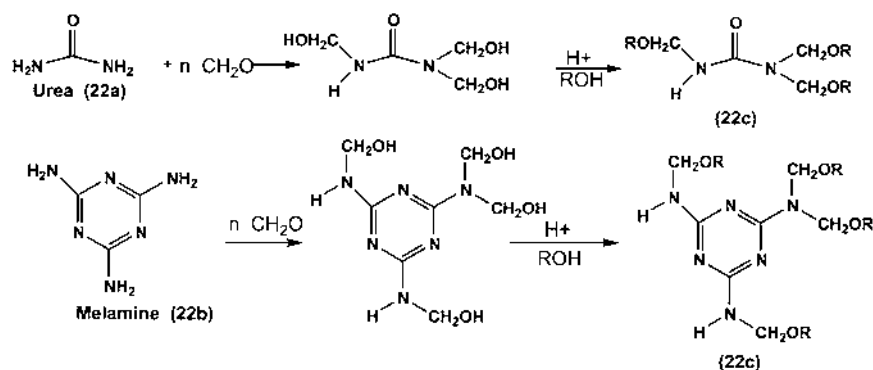

Fig. 22 Methylol groups.



are accompanied by poorer coating stability. The reactions can be forced with very high levels of acid catalyst, but then the coatings are likely to be very sensitive to moisture and have poor durability because the incorporated acid catalyst can accelerate degradation reactions. Typical cure conditions for amino resin-cured coatings are in the range of 90°C to 150°C (200°F to 300°F).

### 3.5.3 Other Crosslinking Strategies

Aside from the use of polyisocyanates and amino resins, other crosslinking chemistries are being used for coatings for plastics. Some of these (epoxy/acid, carbamate, and silane) were discussed in context of acrylic binders (Sec. 3.1), but these crosslinking mechanisms can also be utilized with polyester binders and polyurethane binders by incorporating appropriate functional groups on those materials. In this way, it is possible to gain the more flexible binder backbones and achieve the advantages of the properties of other crosslinking chemistries (16,30).

## 4 RADIATION CURED COATINGS

Radiation (ultraviolet light and electron beam) is a means of curing coatings and can be effectively used for heat-sensitive substrates because the curing can be carried out at ambient temperatures. This is accomplished by incorporating functional groups into the binder resins that are activated by the radiation. The two commonly used functional groups are acrylate(methacrylate) functionality and epoxy functionality. These functionalities are shown in Figure 23.

When the unsaturated acrylate functionality is utilized, curing is initiated by free radicals that are caused by the interaction of the radiation with the binder materials or activators that are incorporated into the formulations. This type of

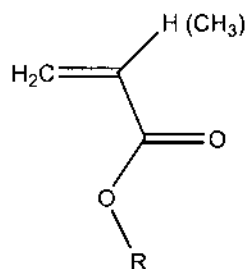

**Acrylate (Methacrylate)**

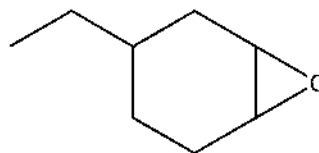

**Cycloaliphatic Epoxy**

FIG. 23 Functionality susceptible to UV radiation curing.

coating can be formulated to very high solids by utilizing reactive acrylate monomers or oligomers as diluents. The curing mechanism proceeds by the chain growth polymerization mechanism (see Fig. 1). As a result of utilizing highly functional monomers or oligomers in the curing process, coatings with high crosslink density can be generated. High crosslink density often yields coatings with very good mar and scratch resistance.

This strategy may cause problems due to the potential toxicity of the acrylate functional monomers or oligomers and curing is only effective in the line of sight of the radiation source. Free radical-initiated chain growth polymerization is also inhibited by oxygen, so inert atmospheres are necessary or formulas can be modified with materials that will react with oxygen. This limits the use of UV cure on complex parts. This concern is being addressed by incorporating dual cure mechanisms that initiate curing by the radiation and continue curing with some thermally activated curing chemistry (31). Because it is relatively easy to modify many types of materials with the acrylate functionality, developing a binder system with desirable properties to match the substrate and the product use is feasible.

Epoxy chemistry is activated by the incorporation of initiators that generate “superacids” when exposed to UV radiation. These acidic catalysts then start the ring opening polymerization of the epoxy groups. Epoxy groups that are sensitive to this type of curing are cycloaliphatic epoxies, as shown in Figure 23. The glycidyl-type epoxy groups that were described previously in the acrylic binder section are significantly less reactive toward this mechanism. The modification of binder systems to cure through radiation-initiated epoxy polymerization is not as versatile, so structure/property development may be more limited than with the acrylate functional schemes.

## **5 POLYMER REQUIREMENTS FOR HIGH SOLIDS, WATERBORNE, AND POWDER COATINGS**

In this section, the requirements to allow polymeric binders to function well in low-emission (high solids, waterborne, and powder) coatings are discussed. The requirements will apply to all of the binder types (including crosslinkers) that were discussed in the previous sections. Along with the features that allow the binders to perform in the low-emission coatings, the limitations that are imposed on the coatings are also discussed.

### **5.1 High Solids (Low Solvent)**

Solvents provide low viscosity to coatings that are needed for conventional application methods (spray, roller coating, etc.). They also control the flow and

leveling properties after application. The ability to adjust the viscosity and polarity of the coating during film formation by solvent evaporation after application has many advantages. When solvents are eliminated, the binder components must accomplish these application functions as well as the function of providing the physical properties of the coating. To make the binder components more like solvent, the usual strategy is to lower the molecular weight. It is also possible to lower viscosity by reducing the intermolecular interactions due to polarity or hydrogen bonding, but this strategy is more limiting and limited to a smaller class of materials. Lower molecular weight in the binder has several effects. Physical properties of polymeric materials is a function of molecular weight. To achieve the high molecular weight needed to have adequate physical properties it is necessary to use thermosetting systems, where molecular weight is achieved by the reaction of multifunctional lower molecular weight materials (oligomers or monomers). To do this effectively requires control of the structure of the molecules. Binder synthesis by chain growth polymerization (e.g., acrylics) is usually a random process. As molecular weights of the polymers are lowered, more of the polymers that are formed will have inadequate numbers of functional monomer units that allow them to participate effectively in the curing reactions. On the other hand, the curing processes will leave unreacted functional groups on those polymers that contain functionality on the high side of the distribution. Often the residual functional groups are sites for degradation or poor performance of the coating (e.g., humidity sensitivity, corrosion, UV degradation, etc.). Bauer has provided a good illustration of the narrowing of the robustness of high solids coatings (32). The cure window that generates acceptable properties (not undercured and not overcured) is significantly smaller for lower molecular weight, higher functional polymers than for higher molecular weight materials with lower functionality. Higher functionality is needed on lower molecular weight materials to achieve the same degree of effective crosslinking. This is shown, schematically, in Figure 24.

Aside from the narrower curing window for good physical properties allowed in high solids coatings, problems of appearance are aggravated. When solvent evaporates from solutions of higher molecular weight materials, viscosity rises quickly and flow is restricted. When nonvolatile, low molecular weight materials are used to achieve high solids coatings, there is no similar sharp increase in viscosity and coatings are more prone to sagging and drips that occur before the coating viscosity is increased by the curing reactions that occur. In effect, the application window for good appearance is significantly narrower than with low solids coatings.

The challenges for increasing the solids of solvent-based liquid coatings are finding more effective rheology control agents to control flow, effective polymer architecture giving better control of the placement of functional groups, and effective catalysis that controls the rate of curing.

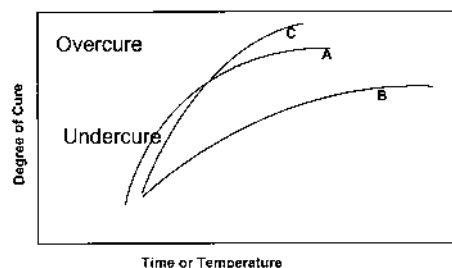

- A Control molecular weight, control functionality
- B Lower molecular weight, control functionality
- C Lower molecular weight, higher functionality

FIG. 24 Cure window behavior.

## 5.2 Polymers for Waterborne Coatings

There are two types of polymers used in waterborne coatings and varieties that fall between these types. The polymers can be “soluble” or dispersed. The soluble polymers are either truly in solution in water (or a combination of water and a cosolvent) or their particle size is small enough so that light is not scattered. The “solutions” are clear rather than milky. The dispersed polymers are particles that are stabilized by internal or external surfactants.

Soluble polymers may contain enough hydrophilicity that they require no other stabilization. The hydrophilicity is provided by neutralized acid (anionic stabilization) or base (cationic stabilization) groups that exist on the polymer backbone. They may contain runs of ethoxylate  $-(CH_2CH_2O)_n-$  that provide hydrophilicity due to polar and hydrogen bonding interactions.

Dispersed polymers can be prepared in an aqueous environment in the presence of surfactants or preformed polymers can be dispersed in water with surfactants and high shear forces. These are called latex or emulsion polymers.

The soluble polymers are lower molecular weight and behave in many ways like organically solubilized polymers, with viscosities being dependent on molecular weight and with the requirement to undergo thermosetting cure to achieve good physical properties. However, the behavior of these polymers in water are significantly more complex than solutions in organic media. There are many references to this behavior (27,33,34) and a significant discussion will not be done here. The soluble polymers form coherent films more easily than the dispersed polymers due to the ability of these lower molecular weight materials to interdiffuse. The presence of the polar or otherwise hydrophilic groups makes these films more sensitive to humidity and aqueous chemical spotting.

Emulsified polymers are higher in molecular weight, but because they

exist in a particulate form, the viscosity of the media is not sensitive to the molecular weight. Therefore, the physical properties are not as dependent on thermosetting curing reactions. On the other hand, these high molecular weight polymers, with their limited diffusion properties, which are in stabilized particles, do not coalesce with ease. Coalescence of these particles is often very incomplete in the film and may take a long time to come to equilibrium. Many references are available for understanding the intricacies of emulsion polymerization and film formation from emulsions (27,35,36).

### 5.3 Polymers for Powder Coating

Polymers and other binder components of powder coatings must be low molecular weight and must have  $T_g$ 's or  $T_m$ 's that are significantly above ambient conditions. The requirement for low molecular weight is to allow enough flow after melting and before curing to attain smooth films. There is no solvent to aid film formation. In order to store and handle powders, the  $T_g$  must be at least 20°C to 30°C above any handling that it encounters. In order to achieve melting and film homogeneity, the cure temperature must be 40°C to 50°C above the  $T_g$ . If the crosslinkers are crystalline or the polymers have some capability of forming crystalline forms, this situation is eased somewhat because the melting point is a much sharper transition than the glass transition.

Practically, the properties discussed previously have limited the use of powder coatings on substrates that cannot be subjected to temperatures above 130°C to 140°C and have precluded their use on many plastic substrates. The melting and flowout of powder materials above the  $T_g$ , but below the onset of cure is difficult with most known crosslinking chemistries. Efforts to develop radiation curable powder coatings (37,38) are ongoing. This concept will allow some narrowing of the powder handling to coating curing window by delaying the initiation of cure until after powder melting and flow is completed. In order to accomplish this task, the chemistry previously described for radiation curing must be incorporated into low molecular weight binders with sufficiently high  $T_g$ 's to withstand powder manufacture and handling requirements.

## 6 CONSIDERATIONS FOR DURABILITY

The overall subject of coating durability, as it relates to coating binders is too broad for consideration in this chapter. Durability can describe many attributes such as resistance to damage from mechanical damage (e.g., mar and scratch) or chemical damage (e.g., etching), but most often it refers to the ability to withstand exterior photooxidative damage. There are chemical moieties in polymers that are well known to be weak against exposure to sunlight. Aromatic urethane structures, ether linkages, carbonyl groups, and carbon-carbon unsaturation are moieties that have been identified as weak spots.

Stabilizers to protect against photooxidative degradation are well known (39). Ultraviolet light absorbers (UVAs) convert light energy into less harmful energy. Hindered amine light stabilizers (HALS) can prevent damage caused by free radical-initiated reactions that do happen on exposure. The stabilizers are often low molecular weight (compared to the polymeric binders) and have the ability to migrate from organic coatings to organic substrates (plastic materials). Consequently, they are often less effective in coatings for plastic substrates due to reduced concentration caused by migration.

To limit migration to the substrate, two strategies have been evaluated. The stabilizing chemical structures are attached to polymeric binder components. The effectiveness of this approach has not yet been established. The barriers are economic—the cost of attaching the stabilizing group to the polymer molecule—and to some degree conceptual. Can the bound stabilizers find their way to the sites of degradation after they are attached to a crosslinked matrix? The alternate approach is to use stabilizer molecules that have chemical groups that react into the binder during the curing stage. An example of this is the use of hydroxyl functional stabilizers in coatings cured with polyisocyanates. For effectiveness, the reaction must be faster than the competing migration phenomena.

## REFERENCES

1. ZW Wicks, FN Jones, SP Pappas. *Organic Coatings: Science and Technology*. 2<sup>nd</sup> ed. New York: Wiley-Interscience, 1999, p. 9.
2. HL Jakubauskas. *J. Coatings Technol*, 58(736);71–82, 1986.
3. RA Ryntz. *Advanced coating technology conference proceedings*. Engineering Society of Detroit, Detroit, MI, April 1997.
4. MP Stevens. *Polymer Chemistry: An Introduction*. 3<sup>rd</sup> ed. New York: Oxford University Press, 1999, p. 100.
5. G Odian. *Principles of Polymerization*. 3<sup>rd</sup> ed. New York: Wiley-Interscience, 1991, chs. 3–5.
6. FH Walker. *Introduction to polymers and resins*. 2<sup>nd</sup> ed. Federation of Societies for Coatings Technology, 1999, p. 32.
7. TG Fox. *Bull Am Phys Soc* 1:123, 1956.
8. ZW Wicks, FN Jones, SP Pappas. *Organic Coatings: Science and Technology*. 2<sup>nd</sup> ed. New York: Wiley-Interscience, 1999, p. 14.
9. L Thiele, R Becker. *Advances in Urethane Science and Technology*. KC Frisch, D Klempner, eds. Lancaster, PA: Technomic Publications, 1993, vol. 12, pp. 59–85.
10. DR Bauer. *Prog Org Coatings* 14:193, 1986.
11. J Lange, A Luise, A Hult. *J Coating Tech* 69(872);77, 1997.
12. G Wagner, M Osterhold. *Mat-wiss u Werkstofftech* 30:617–22, 1999.
13. BV Gregorovich, I Hazan. *Prog Org Coat* 245:131–146, 1994.
14. PJ Schmitz, JW Holubka, L Xu. *J Coatings Tech* 72(904):39–45, 2000.

15. JD Nordstrom, A Dervan. Proceedings 20th International Waterborne, High Solids, Powder Coatings Symposium, 1993, p. 2–14.
16. SV Barancyk, CA Verardi, WA Humphrey. U.S. Patent 5,798,145, August 25, 1998.
17. JW Rehfluss, DL, St. Aubin. U.S. Patent 5,356,669, 1994.
18. HP Higginbottom, GR Bowers, PE Ferrell, LW Hill. J Coatings Tech 71(894): 49–60, 1999.
19. SS Labana, TF Chang, AN Theodore. U.S. Patent 3,758,635, September 1973.
20. DA Simpson, DL Singer, R Dowbenko, WP Blackburn, CM Cania. U.S. Patent 4,650,718, March 1987.
21. WJ Blank. Proceedings 28th International Waterborne, High Solids, and Powder Coatings Symposium, 2001, pp. 297ff.
22. FD Osterholtz, ER Pohl. J Adhesion Sci Technol. 6(1):127–149, 1992.
23. JD Nordstrom. Proceedings 22<sup>nd</sup> Waterborne, High Solids, and Powder Coatings Symposium, 1995, p. 192.
24. Eastman Publications #N330C and N335. Eastman Chemical Company, Kingsport, TN, 1990.
25. G Odian. Principles of Polymerization. 3<sup>rd</sup> ed. New York: Wiley-Interscience, 1991, pp. 110–119.
26. ZW Wicks, FN Jones, SP Pappas. Organic Coatings: Science and Technology. 2<sup>nd</sup> ed. New York: Wiley-Interscience, 1999, p. 76–77.
27. JC Padget. J Coatings Tech 66(839):89–105, 1994.
28. C Kobush, et. al., Presentation at 3<sup>rd</sup> International Coatings for Plastics Symposium Troy, MI, June 2000.
29. JW Rosthauser, K Nachtkamp. Waterborne Polyurethanes, Advances in Urethane Science and Technology. KC Frisch, D Klempner, eds. Lancaster, PA: Technomic Publications 1987, vol. 10, 121–162.
30. PV Yaneff, K Adamsons, RA Ryntz, D Britz. Proceedings of the 28<sup>th</sup> International Waterborne, High Solids, Powder Coatings Symposium, 2001, p.109.
31. K Maag, W Lenhard, H Loffles. Prog Org Coatings, 40(1–4):93–97, 2000.
32. DR Bauer, RA Dickie. J Coatings Tech 54(685):101, 1982.
33. ZW Wicks, FN Jones, SP Pappas. Organic Coatings: Science and Technology. 2<sup>nd</sup> ed. New York: Wiley-Interscience, 1999, p. 468ff.
34. JE Glass. J Coatings Tech 73(913): 79–98 (2001)
35. G Odian. Principles of Polymerization. 3<sup>rd</sup> ed. New York: Wiley-Interscience, 1991, ch. 4.
36. ZW Wicks, FN Jones, SP Pappas. Organic Coatings: Science and Technology. 2<sup>nd</sup> ed. New York: Wiley-Interscience, 1999, p. 33–36.
37. KM Biller, BA MacFadden. U.S. Patent 5,789,039, January, 1996.
38. S Udding-Louwrier, RA Baijards, E Sjoerd de Jong. J Coatings Tech 72(904): 71–75, 2000.
39. A Valet. Light Stabilizers for Paints. Hannover: Curt R. Vincent Verlag, 1997.





# 5

## Performance and Durability Testing

**Philip V. Yaneff**

DuPont Performance Coatings, Ajax, Ontario, Canada

### 1 INTRODUCTION

There are many steps that must be taken to ensure a painted plastic part performs in the needed and expected manner for its particular application. The obstacles and challenges facing the producer of painted plastic parts are numerous and multiple steps must be undertaken and carefully considered before the painter will have the confidence that the needed “quality” will be inherent. The particular grade and type of plastic being used, its method of manufacturing, the cleanliness of the plastic, the paint component layering and selection, and the application method and cure can all affect painted part performance. A deviation in any one of these areas can alter or reduce the expected performance. All of these individual parts cannot be considered independently but must be considered as a total systems approach to ensure acceptable quality of the painted plastic part. The paint-layering system for a typical automotive plastic is shown in Figure 1.

To ensure a painted part meets its intended service need, work must be carried out in advance of commercialization to ensure the appearance, physical properties, durability, and performance of the painted part can meet desired expectations. In the developmental stage, usually molded plaques are painted, examined, and tested to the specification appropriate for the part service. This usually includes exposure under conditions that will likely be encountered during the service. Both accelerated and real-world exposure testing is undertaken at this time. In addition, often panels are tested to failure in conjunction to a known control. Failure mode analysis is important and can be a lengthy and tedious process because not only do we need to consider all the elements the

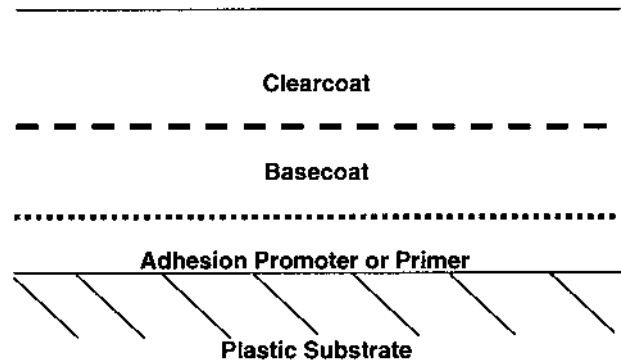

Fig. 1 Typical paint layering system for automotive plastics.

painted part will be subjected to, but we also need to figure out how to accelerate it and obtain the needed data in a timely fashion. The prediction and simulation of failure can be quite difficult to achieve and must correlate with any failure seen in service. Even with all this advanced testing, not all service failures can be predicted.

Once tested panel data is available, both are reviewed with the original equipment manufacturer (OEM) for approval to the required specification. Specifications consistent for the intended application (interior or exterior) are used and usually divided into automotive or nonautomotive categories. While there are some similarities between the automotive and nonautomotive categories, each has their own unique requirements that must be met.

For the purpose of this chapter, discussion and examples will concentrate on the substrates used for today's high-profile automotive bumper applications (predominantly thermoplastic olefin [TPO]) and the conventional adhesion promoters (solventborne, waterborne) and one-component melamine topcoats (1K/1K) and two-component isocyanate topcoat systems (2K/2K and 1K/2K).

## 2 PHYSICAL PROPERTIES

The ability of a painted plastic part to meet the needed physical properties basically means that it has all the necessary performance and expected appearance. Moreover, it retains these properties without physical changes or significant deterioration over the life of the painted part. Of all the physical requirements of a painted plastic part for exterior use, adhesion is usually the most difficult property to retain. Environmental elements and unusual occurrences can also cause deterioration. These factors must be anticipated, designed into the painted part system, and, most importantly, tested for. In the design stage, it is crucial

to test actual parts produced from the customer line to accurately determine what is likely to occur once the paint system is commercialized. Differences in the molding and cleaning of laboratory plaques versus line-produced parts can be quite substantial and relying only on plaque testing can easily lead to a false sense of security, especially when positive results are obtained. Sometimes painting and testing of plastic parts needs to be repeated with different production batches. This will ensure consistent batch-to-batch production and acceptable performance can be achieved on-line.

## 2.1 Appearance

For automotive plastics, it is crucial that the painted part appearance meets or exceeds the required appearance. The standard is usually the automobile body. This can be quite challenging because the plastic part is usually painted vertically and then fastened to the vehicle adjacent to a part that has been painted horizontally. In addition, the OEM assembly plant usually applies higher film builds of paint, especially clearcoat in basecoat/clearcoat systems giving a richer appearance and higher numerical ratings. Commonly accepted appearance attributes consist of color, gloss, distinctness of image (DOI), and smoothness or orange peel. Measuring DOI and orange peel can give rise to difficulties because some of the commercially available equipment can give differing results. Universally accepted equipment should be adopted to help standardize these readings and regularly be recalibrated. Many factors contribute to the overall appearance of a painted plastic part including substrate composition and smoothness, cleanliness, paint application method, part orientation, paint technology, and the amount of paint (1). Some of these factors are shown in Figure 2. However, the ultimate goal is to have a negligible difference in color and appearance between the automobile body and the painted plastic part even though there may be major differences in paint technology and application. Table 1 compares and illustrates some of these differences while Figure 2 demonstrates how processing differences can affect appearance as measured by DOI and orange peel.

Low molecular-weight polymers and additives (especially light stabilizers) can migrate from within the plastic, through the coating to influence the color and haze of the painted part. Surface migration can be most evident with white parts causing yellowing or on black parts showing the presence of a whitish haze or bloom (2). Evolution of entrained gas originating in the plastic can manifest itself as bubbles in the coating through a phenomenon known as out-gassing. This out-gassing, very common with thermoset plastics such as reaction injected molded (RIM) compound and sheet molded compound (SMC), is termed porosity. Porosity can appear as popping or micropopping. Adequate postcure of the plastic substrate as well as a step-down process resulting in a lower temperature with every subsequent bake, can significantly reduce or completely eliminate visual defects from substrate out-gassing.

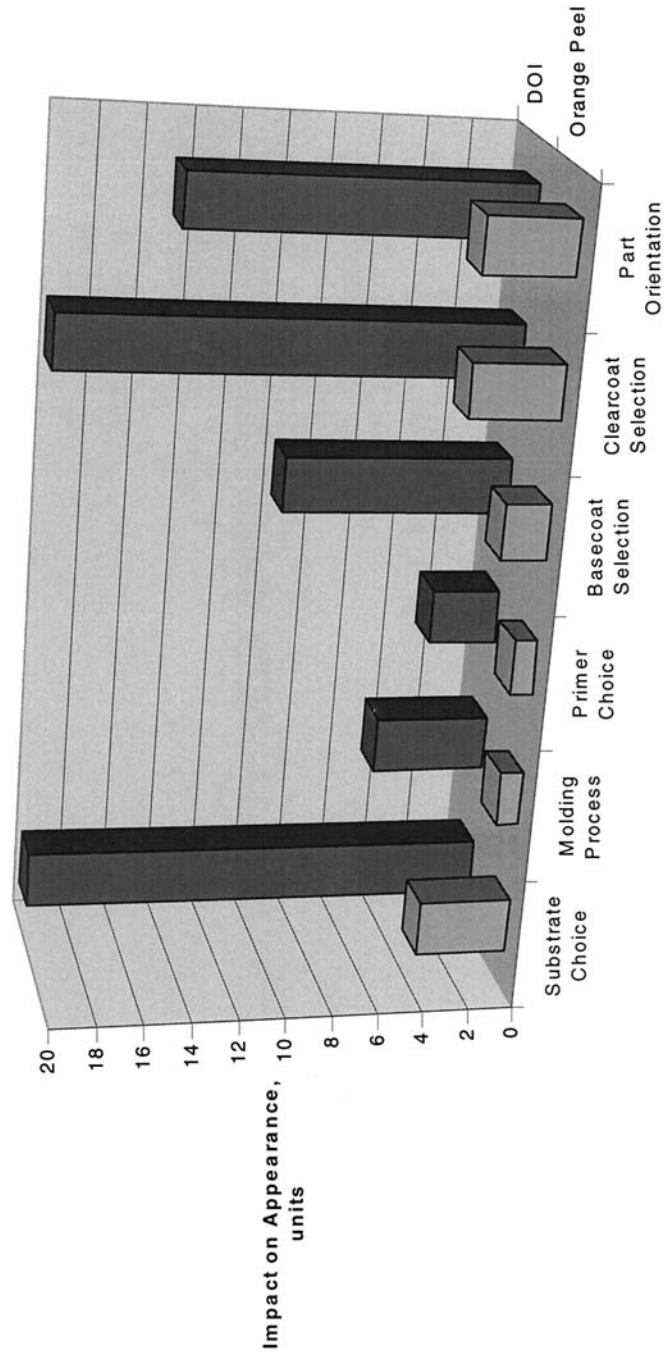

FIG. 2 Impact of substrate, processing, and paint technology on appearance.

Plastics such as SMC, when used as body panels can show defects known as bondline readout (BLRO) (3). BLRO is one form of telegraphing and results from surface tension-gradient flow on the SMC during convection heating/curing of the paint.

## 2.2 Adhesion

Next to a part's appearance, the ability of the paint to adhere to the plastic part is most crucial. Adhesion can be fairly complex and there are many factors that must be considered. In fact, Baghdachi (4) and Ryntz (5) have reviewed many of them. While most adhesion failures occur at the paint-to-plastic interface, topcoat-to-prime delamination (especially when the primer is fully cured) and even repair failures can also occur. In order to ensure adequate adhesion in multilayer coatings, it is necessary that the surface tension of the applied paint be less than the surface tension of the substrate to ensure complete wetting and acceptable adhesion. In multilayer coatings, the surface tension of the applied paint must also be less than the surface tension of the paint layer underneath to ensure strong intercoat adhesion. Two to five dynes surface tension differential is usually enough to ensure excellent results. Stronger adhesion will result if the lower surface tension of the applied coating is predominantly due to the main resin or crosslinker and not to additives or free solvents.

Measurement of contact angles can be very informative and help successfully guide development of multilayer coatings. In fact, matching of the polar component of the applied coating with the polar component of the substrate or the coating underneath is enough to dramatically improve adhesion (6).

Adhesion to plastic substrates can be very complex and challenging. Not only can low molecular-weight materials migrate from within the plastic substrate and impact appearance, but they can also reduce the adhesive strength of the coating and cause weak or premature failure. Of these materials, mold release agents can be the most problematic as they can cause wetting issues and create weak boundary layers. RIM tends to typically display mold-release migration issues in the form of reduced adhesion or even total loss of adhesion. Other defects such as porosity (usually seen in the form of solvent popping) can also result from the presence of mold release agents. Silicone or siloxane surfactants are occasionally used as additives in plastics such as TPO as a free additive or more often as a co-ingredient or surface coating on one of the pigment dispersants. Migration of these low surface-tension materials to the plastic surface can create paint adhesion problems immediately if the rate of migration is fast, or after prolonged exposure or weathering if the rate of migration is very slow. Heat aging can also promote migration of internal mold release (IMR) agents to the plastic-paint interface and weaken paint adhesion.

**TABLE 1** Comparison of the Factors Affecting the Appearance and Durability of Painted Metallic and Plastic Parts

| Property or issue                | Substrate metal                 | Substrate plastic      | Comments   | Impact  |
|----------------------------------|---------------------------------|------------------------|--|---|
| <i>Substrate</i><br>Smoothness   | Smooth                          | Rough<br>Smooth        | Filled RRIM<br>TPO from polished molds             | Poor painted appearance<br>Excellent painted appearance |
| Surface tension                  | High                            | Low                    | Harder to wet                                      | Coating adhesion to plastic?                            |
| Migrating materials              | None                            | IMR                    | Internal mold release                              | Materials migrate from plastic                          |
|                                  |                                 | EMR                    | Materials sprayed on mold to aid release           | Can reduce adhesion                                     |
| <i>Part painting</i><br>Facility |                                 | Formulation/type       | Low MW materials migrate from plastic into coating |   |
|                                  | Usually dedicated               | Multipart styles       | Usually paint many parts on same line              | Some compromises need to be made                        |
| Paint layering                   | E-coat<br>Primer (always baked) | None<br>May be present | Primer can reduce migration from substrate         | Can improve chip and adhesion                           |
| Topcoat technology               | Higher bake                     | Usually lower          | Plastic heat distortion limits bake temperature    | Lower crosslink density                                 |

|                             |                         |                             |  |   |
|-----------------------------|-------------------------|-----------------------------|--|---|
| <i>Appearance</i>           | Painted in car position | A' surface painted verticle | Lower orange peel on plastic due to gravity/flow | Poor fascia to body match                     |
| Amount of clearcoat applied | High (meet spec)        | Usually lower               | Parts industry raising clearcoat film builds     | Inferior appearance and durability            |
| <i>Paint Formulation</i>    | Usually higher $T_g$    | Usually lower $T_g$         | Plastic parts are more flexible                  | Coatings for plastics have better flexibility |
| Chip                        | Good                    | Very good                   |  | Reduced stone chips on plastic parts          |
| Etch                        |                         |                             | Rigid coatings generally have better etch        | More visible etch on dark-colored fascia      |
| Repair                      | Usually spot            | Usually repaint             | Plastic repair more costly                       | Plastic parts may contain more layers         |

Simple adhesion testing can be done by applying some sort of scribe into the painted part followed by applying a piece of tape, rubbing it to ensure good adhesion, and then rapidly lifting the tape in an upward motion. An example of this type of adhesion testing is ASTM D 3359. While many adhesion test variations exist (cut patterns, types of tape, pull rates), they all can quantify the amount of paint delamination numerically or relative to a standard. Low surface-tension agents in the coating can artificially reduce the adhesive strength of the tape to the coating and thus give false readings. Removing the surfactant from the surface through solvent wiping can ensure more meaningful and representative results. Multiple paints passing the tape adhesion test does not necessarily differentiate between adhesive strengths and more sophisticated testing can be useful. Peel strength testing can be performed on painted plastics using a tensile tester (7). This destructive test procedure can give the energy necessary for paint removal and allows the comparison of one paint to another. More recently, an in situ adhesion test, described as compressive shear delamination (CSD), has been reported to quantify the adhesive/cohesive strength of coatings to a variety of TPO substrates (8) that eliminates the artificial film between the paint and the adhesion promoter.

Not only is adhesive testing carried out under dry conditions but also under wet conditions. Exposing the painted part to a humidity chamber (typically 100% relative humidity at 38°C) for 96 to 240 hours can increase the likelihood of paint delamination as moisture can penetrate through the coating layer into the substrate. Increasing the temperature to 140 or 160°C as in the Cleveland Humidity Chamber can further test the adhesive properties of the painted part. With the formulator performing testing under conditions that are much more severe than specified by the OEM, it is likely to increase the chance of success at the customer, even under conditions that are usually less than ideal.

In an attempt to upgrade the adhesive strength to TPO, more demanding adhesion tests have been introduced. These include thermal shock, water jet, and the gasoline soak. The latter will be covered in Section 2.3. In the thermal shock test, a coated panel is stored at cold temperature for a minimum of four hours after being scribed with an X. High-pressure steam is then bombarded at the center of the X for 30 seconds. Any paint loss, whether it was adhesive or cohesive within the TPO, is recorded.

Coatings have been observed to fail in this test on TPO, usually through cohesive delamination within the TPO. The results improve significantly if the TPO has seen a bake temperature of at least 121°C. Explanations have been proposed suggesting that a morphological change within the TPO is necessary allowing the rubber to move closer to the surface for greater penetration. Data have shown that this 121°C thermal exposure dramatically improves thermal shock testing and is necessary for paint systems to consistently pass this test. The OEMs that use low-bake paint systems that do not reach this needed tem-



perature do not consistently pass this test, but still give acceptable field performance without any significant warranty issues. The water-jet test closer emulates what happens in a do-it-yourself car wash, especially in the winter. In this test, the cold painted part is scribed with a  $10 \times 10$  line grid and then bombarded with high-pressure water for 30 seconds. Unlike the thermal shock test, any paint removal is usually adhesive loss. While some OEMs allow up to 20% removal, in reality, any paint loss gives reason for concern. The use of stronger adhesion promoters and tougher topcoats are generally enough to give excellent water-jet performance on today's TPO plastics. Including an additional processing step such as flame treatment ensures successful thermal shock and water-jet performance for low-bake systems as compared to high-bake systems (Table 2).

### 2.3 Gasoline Resistance

Gasoline-resistance testing has been included in case any fuel is spilled on the plastic part. Early test methods were introduced to indicate acceptable cure. When the gasoline dip test was initially introduced, 25 to 50 solvent dip cycles were required in a hydrocarbon mixture blend of synthetic gasoline to pass. More recently, the test was upgraded to include a scribe (as done for the adhesion test) and then the panel soaked in the solvent blend for up to one hour. Many of the available chlorinated polyalpha olefins (CPOs) would not meet these upgraded requirements and new materials were needed. With the introduction of gasoline-alcohol blends (gasohol), some OEMs added 10 to 15% ethanol to the gasoline blend. This increased even further the need for CPOs with stronger gasohol resistance as the alcohol quickly weakened the plastic-to-adhesion-promoter interface. Strengthening the paint layering system above the adhesion promoter can also improve the results of this test. Performing some type of adhesion test after removing the panel from the test solution can provide an added level of comfort as this is much more severe than required by the OEM.

### 2.4 Gouging

Substrate gouging has been prevalent with automotive TPO bumpers and to the naked eye it looks like a simple paint delamination issue. However, this failure is localized within the substrate. This gouging or friction induced paint damage is commonly seen with TPO substrates and can be reduced through judicious selection of paint clearcoat chemistry, optimizing the paint formulation and through the use of silicone additives (9). The use of high levels of silicone can interfere with the next coating layer and migrate upward when recoated (10) affecting color and/or recoat adhesion. Therefore, silicone additives must be thoroughly studied prior to addition, especially if other paint suppliers are used on the same paint line.

In the gouging process, a painted plastic part is hit by or hits a foreign object (often another painted part). Failure occurs cohesively within the sub-

**TABLE 2** Thermal Shock and Water Jet Results for Low-Bake (82°C) and Comparison with High-Bake (121°C) Paint Systems

| Pretreatment | AP           | Technology | Color    | Bake        | Thermal shock | Water jet           |
|--------------|--------------|------------|----------|-------------|---------------|---------------------|
| None         | Waterborne   | 1K/1K      |          | 25 at 121°C | Pass          | Pass                |
| None         | Solventborne | 1K/1K      |          | 25 at 121°C | Pass          | Pass                |
| Flame        | None         | 1K/1K      | Black    | 25 at 121°C | Pass          | Pass                |
| Flame        | Waterborne   | 1K/1K      |          | 25 at 121°C | Pass          | Pass                |
| Flame        | Solventborne | 1K/1K      |          | 25 at 121°C | Pass          | Pass                |
| None         | Waterborne   | 1K/1K      |          | 25 at 121°C | Pass          | Pass                |
| None         | Solventborne | 1K/1K      |          | 25 at 121°C | Pass          | Pass                |
| Flame        | None         | 1K/1K      | White    | 25 at 121°C | Pass          | Pass                |
| Flame        | Waterborne   | 1K/1K      |          | 25 at 121°C | Pass          | Pass                |
| Flame        | Solventborne | 1K/1K      |          | 25 at 121°C | Pass          | Pass                |
| None         | Waterborne   | 1K/1K      |          | 25 at 121°C | Pass          | Pass                |
| None         | Solventborne | 1K/1K      |          | 25 at 121°C | Pass          | Pass                |
| Flame        | None         | 1K/1K      | Blue     | 25 at 121°C | Pass          | Pass                |
|              |              |            | metallic |             |               |                     |
| Flame        | Waterborne   | 1K/1K      |          | 25 at 121°C | Pass          | Pass                |
| Flame        | Solventborne | 1K/1K      |          | 25 at 121°C | Pass          | Pass                |
| None         | Waterborne   | 1K/2K      |          | 25 at 82°C  | 25.25 mm      | 405 mm <sup>2</sup> |
| None         | Solventborne | 1K/2K      |          | 25 at 82°C  | 18.43 mm      | Pass                |
| Flame        | None         | 1K/2K      | Black    | 25 at 82°C  | Pass          | Pass                |
| Flame        | Waterborne   | 1K/2K      |          | 25 at 82°C  | Pass          | Pass                |
| Flame        | Solventborne | 1K/2K      |          | 25 at 82°C  | Pass          | Pass                |
| None         | Waterborne   | 1K/2K      |          | 25 at 82°C  | 22.72 mm      | 252 mm <sup>2</sup> |
| None         | Solventborne | 1K/2K      |          | 25 at 82°C  | 6.05 mm       | 99 mm <sup>2</sup>  |
| Flame        | None         | 1K/2K      | White    | 25 at 82°C  | Pass          | Pass                |
| Flame        | Waterborne   | 1K/2K      |          | 25 at 82°C  | Pass          | Pass                |
| Flame        | Solventborne | 1K/2K      |          | 25 at 82°C  | Pass          | Pass                |
| None         | Waterborne   | 1K/2K      |          | 25 at 82°C  | 9.33 mm       | 603 mm <sup>2</sup> |
| None         | Solventborne | 1K/2K      |          | 25 at 82°C  | Pass          | 81 mm <sup>2</sup>  |
| Flame        | None         | 1K/2K      | Blue     | 25 at 82°C  | Pass          | Pass                |
|              |              |            | metallic |             |               |                     |
| Flame        | Waterborne   | 1K/2K      |          | 25 at 82°C  | Pass          | Pass                |
| Flame        | Solventborne | 1K/2K      |          | 25 at 82°C  | Pass          | Pass                |

strate and results in the removal of the paint and a thin layer of substrate and often appears like paint delamination. Because many automotive bumpers exhibit this type of damage, a new gouge test requirement using an apparatus called Slido has been developed and incorporated into some OEM specifications for TPO substrates. Figure 3 shows typical Slido measurement equipment.

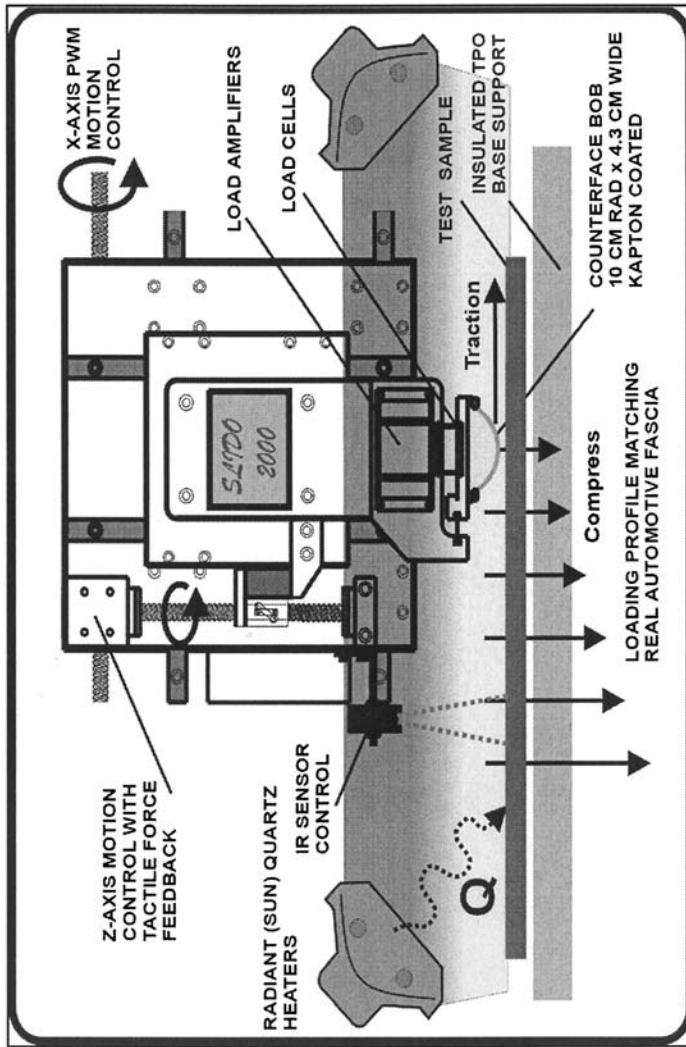

FIG. 3 Slido equipment for gouge measurement.

## 2.5 Chipping

The ability of a painted plastic part to withstand the impact of foreign objects such as small stones and gravel has been extensively reviewed by Ryntz et al. (11,12). Test methods range from the simple projectile of small stones at cold substrate (e.g., SAE J400) to the more precise impact tests described by Ryntz and others. In a fully painted plastic bumper, chip damage can occur:

1. Within the clearcoat
2. At the basecoat/clearcoat interface
3. Within the basecoat
4. Within the primer or adhesion promoter
5. At the paint-to-plastic interface
6. Within the plastic

The flexural properties of the substrate and the paint system used, the adhesive strength of the paint layers, and the cohesive integrity of the substrate and paint layers all can influence the location and severity of any chip damage seen.

In general, flexible substrates (i.e., flexural modulus less than 700 MPa) damage very little, if at all, upon impact. However, with the current industrial trend toward higher modulus materials of 1200 to 1600 MPa, more damage will result. In fact, with the same paint system, much poorer chip performance will result on these higher modulus substrates than on lower modulus substrates. Therefore higher flexibility coatings are being developed and commercialized that offer the desired level of chip resistance on these higher modulus, stiffer grades of TPO.

## 2.6 Flexibility and Impact

Plastic coatings need to have their flexibility appropriate for the substrate being tested and the intended application. A coating's flexibility predominantly stems from the glass transition temperature ( $T_g$ ) of the coating backbone resin, the coatings crosslink density (XLD), the structure of the segments between crosslinks, the amount of dangling polymer chains, and the extent of backbone cyclization, if any (13). Coatings formulated with low  $T_g$  resins and low crosslink density, generally exhibit the highest degree of flexibility, especially at cold temperatures.

Flexibility tests range from the relatively simple mandrel bend where a cut piece of painted substrate is bent around a specified size cylindrical mandrel. The size of the mandrel selected is directly related to the degree of strain desired and typically increases as the temperature decreases. Because the relevance of this type of bend test is questionable in real-world testing, impact testing, especially at cold temperatures, has become more important. In a typical multiaxial

test, a dart is dropped at a specified height, rate, and temperature into the panel. The mode of failure (ductile or brittle) and energy to break are both used as criteria to determine the suitability of the system. Because the mechanical properties of the cured coating are usually more brittle than that of the unpainted substrate, painted parts usually exhibit weaker impact performance, especially at cold temperatures.

As mentioned in Section 2.5, the trend to higher modulus substrates will also reduce the painted part impact performance. Coating systems showing ductile failure when tested with a 790 MPa TPO can exhibit brittle failure when tested with a 1500 MPa TPO (Table 3). The current trend is to increase the coating flexibility to compensate for the more brittle substrate and still maintain acceptable low-temperature impact performance. Of course, other painted part properties (e.g., environmental etch, out-of-oven finessability) will likely be compromised with this change.

## 2.7 Scratch and Mar

Minimal scratch-and-mar damage is considered a very important positive attribute when considering the overall durability of a coating on any substrate (14). Scientific knowledge is lacking to understand the exact mechanism of marring and techniques such as the scanning probe microscope with a custom-made probe (15) have proved helpful to measure coating mar resistance at micron and submicron scales and provide mechanistic information. Plastic coatings usually demonstrate excellent scratch-and-mar resistance, as they usually possess a lower  $T_g$  than do rigid coatings. In automotive, car washing is the single most detrimental contributor to this type of damage through what is known as wet marring. Coated plastic parts can also be damaged through other means such as hand polishing (dry mar damage). Many test procedures are used to reproduce the damage encountered from this type of marring, but not all correlate with the exact type of damage produced (16). There is no single quantity that expresses

**TABLE 3** Impact of Substrate Modulus on Low Temperature Ductility<sup>a</sup>

| TPO Modulus (MPa) | Coating A | Coating B |
|-------------------|-----------|-----------|
| 550               | Ductile   | Ductile   |
| 780               | Ductile   | Ductile   |
| 960               | Ductile   | Brittle   |
| 1240              | Ductile   | Brittle   |
| 1560              | Brittle   | Brittle   |

<sup>a</sup>Coating A is more flexible than coating B. All testing performed at  $-15^{\circ}\text{C}$ .

the mar resistance of a coating. In fact, mar resistance will always depend on the measurement conditions (17). A quantitative, reliable, and robust method for measuring the critical load for clearcoat fracture using cube corner indenters has recently been described by Jardet et al. (18) that can be used to measure scratch durability.

A crockmeter is the typical piece of equipment used (19). Immediately after curing, plastic parts may be handled and subjected to in-part marring while being removed from the paint line and even during shipment. Upon weathering, coatings tend to lose some of their elasticity and can become more susceptible to a greater degree of scratch-and-mar damage. However, some coatings (especially urethanes) can reflow, and thus minimize this type of damage, when exposed to the sun and heated up to temperatures as high as 90°C. This healing is due to the pseudoplastic nature of the coating and is irrespective of the scratch technique used (20).

Laboratory testing to predict the amount of damage a coating is likely to see during service has been quite varied and can utilize many techniques from the simple wet, dry, crockmeter (21), Taber testing, to the sophisticated slido (22) and the single indenter microscratch test (23). Even an assessment of the degree of scratch damage can involve either the naked eye, a gloss meter, or even the digital-based VIEEW image system (24).

## 2.8 Etch and Chemical Resistance

Environmental etch fallout is one of the main sources of damage on basecoat/clearcoat systems especially on dark colors such as black and dark blue. Sources of potential damaging ingredients include acid rain, acidic environmental fallout, and bird droppings. Standard testing involves exposing painted parts outdoors in an area that is prone to high levels of environmental fallout. Jacksonville, Florida is such a site and annually hosts the exposure of OEM coatings in the summer months. A 14-week period is commonly accepted as the normal exposure period to measure the amount of damage, relative to a control. A 0 to 12 rating system has been established to assess the part damage after this exposure period. Ratings less than four are desired to match that obtained on the car body with the OEM rigid coating. The belief is that customers will not complain at damage four or less, although many plastic surfaces are fairly small and do not readily exhibit etching. Because conditions can dramatically differ from one year to the next, it is recommended that multiple-year data be obtained with the same paint system in order to ensure a degree of confidence to the data obtained in a particular year.

In general, plastic coatings are baked at lower temperature (80 to 121°C) than coatings used on steel (130 to 150°C) and are formulated with a higher degree of flexibility. Both these contribute to giving weaker overall environmen-

tal etch performance. Because the expectation that the painted steel and plastic part exhibit the same amount of environmental damage, flexible coatings need to be more etch resistance to ensure the plastic part exhibits equivalent performance to the rigid body.

Laboratory tests have been developed to measure the relative damage of coatings to known contaminants, which are usually highly acidic. Test protocols using equipment such as gradient ovens and various solutions can help to determine the minimum “damage free” temperature of a specific coating relative to a known or commercial control. In general, lower pH conditions induce more severe damage and results have been observed to depend greatly on the type of coating film exposed (25). However, there is usually a poor correlation of the environmental fallout damage encountered in the Jacksonville summer testing with the laboratory gradient oven results. Schmitz et al. have developed laboratory test methodology evaluating the bulk acid hydrolysis resistance of clearcoats (26) by gravimetrically following material weight loss as a function of exposure time to sulfuric acid solution. These authors subsequently applied x-ray photoelectron spectroscopy as a tool to show that the exposure conditions used in this laboratory etch testing simulates field degradation pathways and gives credence to the acid hydrolysis mechanisms for etching that results from acid-rain exposure (27).

The choice of clearcoat technology strongly influences the amount of etch damage. Specifically, clearcoat crosslink density and the ease with which the clearcoat can be hydrolyzed all affect the amount of etch damage. Highly crosslinked clearcoats, formulated with the high  $T_g$  resins usually provide the highest level of protection to acid-related damage. Two-component clearcoats (isocyanate crosslinked) are considered state-of-the-art for exhibiting the least amount of etch damage and typically display Jacksonville ratings of 4–7. One-component clearcoats are much weaker with melamine crosslinks as they are more susceptible to acid hydrolysis of the ether linkage and typically exhibit readings in the 10–12 range. Recently, one-component melamine hybrid coatings crosslinked with carbamate (28) or silane (7) resins offer etch resistance very close to 2K coatings but with far superior scratch-and-mar performance. Table 4 shows some 14-week Jacksonville ratings for typical OEM flexible and rigid coatings.

### 3. MECHANICAL PROPERTIES

#### 3.1 Initial Properties

The mechanical properties of coated plastic parts are largely determined through a combination of the paint formulation and the plastic substrate. When we refer to mechanical properties, we are referring to properties such as hardness, flexibility, impact, solvent and abrasion resistance, and even adhesion. Schoff (29)

**TABLE 4** 14-Week Jacksonville Etch Ratings for Some OEM Basecoat/Clearcoat Systems

| Paint system    |                               | Flexibility | Rating |
|-----------------|-------------------------------|-------------|--------|
| <i>Basecoat</i> | <i>Clearcoat</i> <sup>a</sup> |             |        |
| 1K Melamine     | 1K Melamine                   | Rigid       | 10     |
| 1K Melamine     | 1K Melamine                   | Flex        | 12     |
| 1K Melamine     | 2K Isocyanate                 | Rigid       | 4–5    |
| 1K Melamine     | 2K Isocyanate                 | Flex        | 6–7    |
| 1K Melamine     | 1K Silane                     | Rigid       | 5      |
| 1K Melamine     | 1K Silane                     | Flex        | 7      |
| 2K Isocyanate   | 2K Isocyanate <sup>b</sup>    | Flex        | 3–5    |

<sup>a</sup>High-bake coatings baked at 121°C.

<sup>b</sup>Low-bake system, baked at 82°C.

has given a basic description of this testing methodology; discussed the advantages and disadvantages of each; and reviewed what information can be obtained and how it may be used. Mechanical properties are greatly influenced by the coating's formulation and are determined by the coating's  $T_g$ , the coating's backbone resin structure, the degree of crosslinking, and the viscoelastic properties of the coating. Hill (30,31) has reviewed and discussed these concepts in great detail and their impact on the properties previously mentioned. Microtoming or depth profiling of multilayer systems (discussed in Section 6.3.1 for light stabilizers) can also be used to determine the depth dependence of the coating mechanical properties (32). In general, the inherent mechanical properties of automotive plastics are much superior to the coating being used and as such, the coating is usually considered the weakest link in the system.

Stress can build up in a coated plastic part and can affect coating mechanical properties. Stress can accumulate during film formation and from variation in relative humidity and/or temperature (33). Even differences between thermal expansion coefficients of the substrate and the coating can induce stress. The dissipation of accumulated stresses is key to avoiding premature system failure.

Of the coating properties, the coating  $T_g$  is probably considered the most important design parameter of a coating for plastic paint. Because mechanical properties can change tremendously at  $T_g$ , it is advantageous to have the coating system  $T_g$  optimized for the substrate being used. The  $T_g$  of the coating is determined through the choice of backbone resin, type of crosslinker, and the use of any reactive diluents. In general, the lower the  $T_g$  of the coating, the stronger are the mechanical properties such as flexibility and impact resistance. Higher  $T_g$  coatings exhibit greater hardness and stronger solvent resistance. However,



in reality, compromises are usually necessary to ensure the coated plastic part meets the required end-use criteria.

### 3.2 Properties after Aging and Weathering

For optimum performance, the mechanical properties of the coated plastic part should not significantly change as the coating ages. This can be quite challenging because many changes can occur not only on the coating's surface, but also within the plastic. Destruction from film erosion, polymer degradation, and the loss of crosslinks all can contribute to harder, less flexible, higher  $T_g$  films. Measurement of physical properties through dynamic mechanical analysis (DMA) and other techniques (34,35) has led to an understanding of the stresses in automotive paint systems and how increased stress build-up can dissipate through clearcoat cracking, loss of cohesion, and/or paint delamination. The main sources of stresses developed during exposure have been identified from the thermal expansion coefficient mismatch, humidity expansion mismatch, and densification of the clearcoat (36). Evaluating both the degradation of the coated panels appearance and properties such as stress measurements (37) can be an important way of studying coating durability and even help to predict the eventual mode of failure, as the coating undergoes physical aging.

## 4 WEATHERING

How a coating will weather in its intended environment can be the most difficult parameter to accurately predict and has been addressed by many authors using various techniques (38,39). Sometimes, predicting durability can be very challenging due to shifts in weather patterns. To make matters worse, how can the weather even be the same year after year? Macro and micro changes in the climate can dramatically affect outdoor exposure results by way of UV radiation, temperature, humidity, dew formation, and overall climatic changes (40). Unfortunately, even exposing a coated plastic panel under the most severe expected conditions cannot always predict how long a coating will last or by which mode will it fail.

### 4.1 Natural Weathering

What is natural weathering? A coating will weather differently if exposed in the hot, wet climate of Florida or the hot dry climate of Arizona or Venezuela. Moreover, the same coating can age differently even when exposed from one year to the next because climates can vary significantly from one year to another. Typically coatings are exposed outdoors for annual periods of 1 to 10 years. A coating exposed for one year starting in January can weather differently from the same coating exposed in the July or August time frame. This difference

can be strongly influenced by seasonal variation in the ozone concentration (41). Although it is extra work for the paint formulator, it is always best to expose a new coating along with a commercial control. This will help to ensure that the coating is equal to or superior to the control. Also if the control is known to fail using a particular mechanism, one can learn if the newer coating will fail by the same mechanism or not, and if so in what time frame.

Failure modes can also differ depending on where in the world the coating is exposed. Some coatings can weather well in humid environments and then degrade rapidly when exposed to dry environments containing high amounts of UV intensity. It is always best to expose the coating in the environment to which the actual plastic part will be exposed. This however, while desirable in most instances, may not be practical. Many factors can influence the climate for exposure and can include solar radiation (UV wavelengths), heat (affects the material surface temperature), moisture (dew, rain, humidity), and atmospheric pollutants (acid rain, ozone, aerosols).

In automotive, 10-year durability is the ultimate goal. What does this really mean? For most consumers, they want the coating to look similar to when it was new and not show visible damage, especially when it is clean and polished. This is why considerable emphasis is placed on outdoor exposure. Accelerated exposure can help to show trends or provide early information, but actual exposure panels always take precedence over any accelerated exposure.

Exposing panels is not straightforward and can involve many permutations. In fact, panel exposure can be considered unsimilar to real-world service life but similar to accelerated outdoor testing (42). In automotive, the most common exposure specified by OEMs is in south Florida with the panels facing 5° from the perpendicular on a fence. Less severe exposure (and less degradation) can result from exposure at higher angles from the perpendicular (e.g., 45°). On the other hand, more severe exposure will result when the panel is exposed at a higher temperature. This can be accomplished through black box exposure. In this type of exposure, panels are mounted on a closed wooden box (ASTM D-4141) and the temperature increases considerably relative to the open-back fence (ASTM G-7). This results in higher exposure temperatures and faster degradation. The exposure conditions selected should represent what the part will see in field service.

Flexible coatings are much softer than rigid coatings and therefore can embed dirt that has been deposited on the panel. Periodic washing is crucial to remove these deposits and thus extend the appearance lifetime as shown in Table 5. Table 5 shows two sets of exposed panels with 1K and 2K clearcoats. The first set was washed every three months and the appearance data read, whereas the other set was only washed annually and the data read. The accumulation of dirt was believed responsible for the reduced appearance readings, especially on the softer 1K clears as opposed to the harder 2K clears.

**TABLE 5** Impact of Panel Washing Frequency on Florida Exposure Results

| Panel # | Substrate | Primer            | Basecoat color      | Clearcoat Chemistry | % Gloss retention after 36 months |          |
|---------|-----------|-------------------|---------------------|---------------------|-----------------------------------|----------|
|         |           |                   |                     |                     | Every 3 months                    | Annually |
| 1       | TPO       | Adhesion promoter | Black               | 1K Melamine         | 64                                | 37       |
| 2       | RRIM      | Flexible primer   | Black               | 1K Melamine         | 62                                | 33       |
| 3       | TPO       | Adhesion promoter | White               | 1K Melamine         | 84                                | 71       |
| 4       | RRIM      | Flexible primer   | White               | 1K Melamine         | 84                                | 68       |
| 5       | TPO       | Adhesion promoter | Silver              | 1K Melamine         | 87                                | 70       |
| 6       | RRIM      | Flexible primer   | Silver              | 1K Melamine         | 86                                | 63       |
| 7       | TPO       | Adhesion promoter | Light blue metallic | 1K Melamine         | 74                                | 54       |
| 8       | RRIM      | Flexible primer   | Light blue metallic | 1K Melamine         | 77                                | 47       |
| 9       | TPO       | Adhesion promoter | Medium garnet red   | 1K Melamine         | 76                                | 68       |
| 10      | RRIM      | Flexible primer   | Medium garnet red   | 1K Melamine         | 63                                | 60       |
| 11      | TPO       | Adhesion promoter | Black               | 2K Isocyanate       | 82                                | 76       |
| 12      | TPO       | Adhesion promoter | White               | 2K Isocyanate       | 93                                | 90       |
| 13      | TPO       | Adhesion promoter | Silver              | 2K Isocyanate       | 89                                | 84       |
| 14      | TPO       | Adhesion promoter | Light blue metallic | 2K Isocyanate       | 82                                | 79       |
| 15      | TPO       | Adhesion promoter | Medium garnet red   | 2K Isocyanate       | 85                                | 81       |

Panels exposed at 5°S in Miami, FL for 36 months.

## 4.2 Accelerated Testing

Many methods for obtaining information as to how a coating may weather in a shorter, accelerated time frame are currently available. Unfortunately, exposing coated panels in some or all of these test devices will not give the same result. This is due to the difference in the amount of radiation emitted by the accelerated device at various wavelengths and temperatures. The establishment of an equivalent light dose factor (ELD) has been useful for the reduction of gloss between Florida and accelerated weathering tests (43). Certain coatings will weather dramatically different depending on the exposure method used. In fact, some coatings can fail by a mechanism that will never be seen in actual service.

The most important criteria for selecting an accelerated exposure method are based on the previously established correlation between the accelerated method and the actual field service (44). In some instances, this can be a very difficult challenge because actual field service data can be very rare and hard to find. Even exposure of some coating systems have been found to correlate fairly close to Florida weathering data for some polyester resin types but not for all the polyesters studied (45). In some instances, unexpected results have been found, such as those by Sullivan and Cooper (46), for a series of polyester resins exposed in Florida and in various accelerated weathering methods. The results were explained using molecular orbital calculations and this work has led to a better understanding of degradative process fundamentals of polyester coatings.

In summary, the utilization of accelerated weathering devices can be useful for testing painted plastic parts when data exists relating accelerated exposure data to real long-term field data. Caution should always be exercised and accelerated data should be used in conjunction with other real-time test data.

## 4.3 Xenon Arc Weatherometer

The xenon arc weatherometer has become fairly popular and accepted as giving a stronger correlation with natural weathering. This is because the wavelength of light emitted closely matches that of natural sunlight, although higher irradiance is emitted in the 450–500 nm range and above 600 nm. The xenon also does emit some radiation below 295 nm and must be filtered out for the closest match to sunlight (Fig. 4). The ASTM J1960 test procedure (47) specifies using quartz/borosilicate filters (ASTM G-26). This combination does not completely out the 295 nm radiation and can result in coating failure that does not correlate with outdoor exposure. Bauer et al. (48) have compared various accelerated weathering devices for a polyesterurethane coating and concluded that none of the devices provided output correlating with that obtained with photoacoustic-FTIR spectroscopy. This was surprising because the Ford test procedure specifies inner and outer borosilicate filters that are supposed to filter out almost all

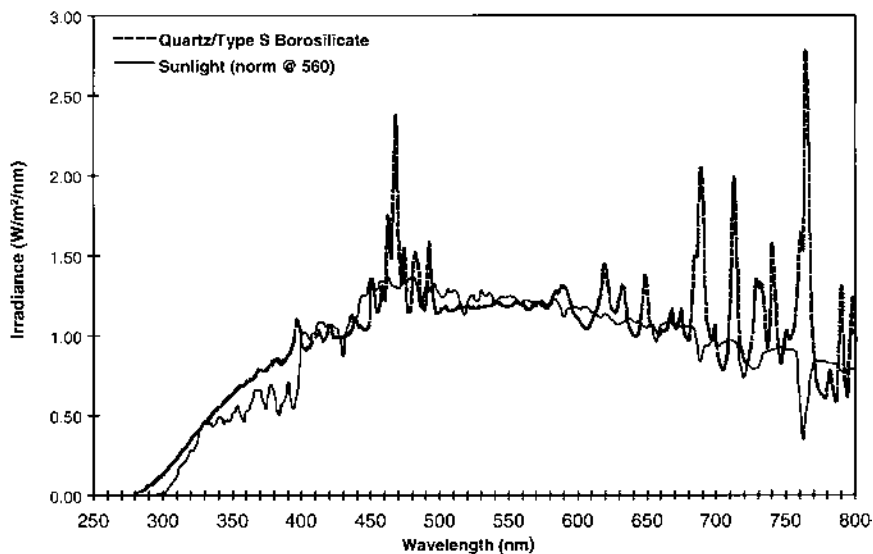

FIG. 4 Xenon arc (quartz/boro) vs. natural sunlight. (Data courtesy of Atlas Material Testing Solutions.)

of the radiation below 295 nm (Fig. 5). John Gerlock at Ford Research continues to evaluate different filtering systems that will allow a very, very close match to natural sunlight (J. Gerlock, personal communication, 1999).

Certain resins commonly used in formulating flexible coatings are based on isophthalic acid (IPA). The aromatic nature of this functional group is such it can be readily attacked by UV light and lead to failure through cracking after 2500 KJ in a xenon weatherometer. Panels of the same coating exposed in sunlight do not fail by cracking. Therefore, the light in the xenon weatherometer is inducing chemical changes within the coating that will not occur in reality. Using the xenon arc to accurately predict the durability of coatings based on IPA can lead to erroneous and in fact, wrong conclusions. However, altering the distribution of UV radiation by replacing the quartz/borosilicate filters with borosilicate/borosilicate filters can eliminate this cracking mechanism and produce excellent-looking panels after 2500 KJ of exposure (P. V. Yaneff, unpublished results). Unfortunately, many OEM manufacturers still require excellent xenon results of coating systems on plastic in addition to Florida weathering. Therefore, based on this criterion, coatings that can perform very well in natural weathering could never be approved for OEM use because they fail prematurely when exposed in a xenon weatherometer with quartz/borosilicate filters.

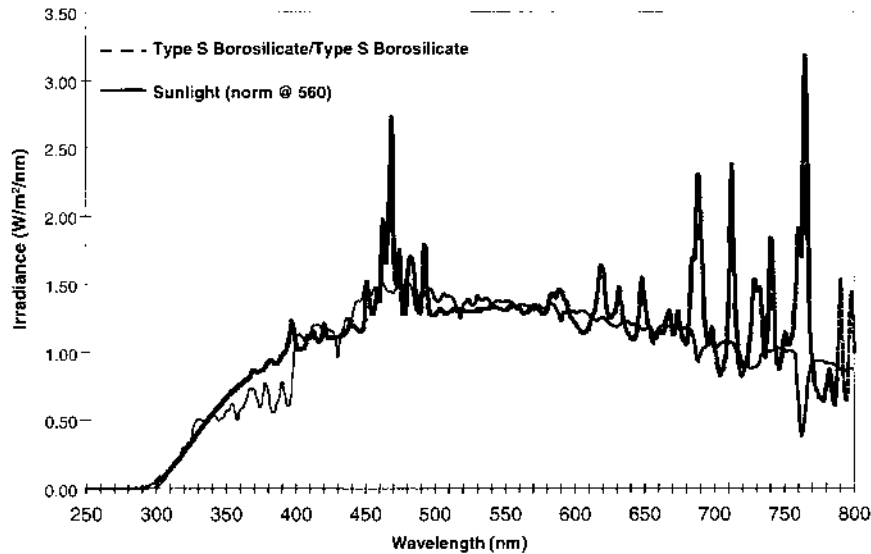

FIG. 5 Xenon arc (boro/boro) vs. natural sunlight. (Data courtesy of Atlas Material Testing Solutions.)

Many OEMs require coatings for plastics to pass a minimum of 2500 KJ of exposure in the xenon arc. This takes approximately three months to complete and appears to correlate with two years exposure in south Florida (49) and therefore, has an acceleration factor of eight. As the trend for better durability and appearance retention continues, longer exposure periods of 3500 to 5500 KJ are being specified. The latter requires almost one year of accelerated weathering to complete. Obviously, a xenon weatherometer capable of higher wattage output, which could achieve 5500 KJ in a relatively shortened time frame, would be extremely beneficial to the entire coatings industry.

#### 4.4 Quartz Ultraviolet (QUV) Weatherometer

Although UV radiation is usually largely responsible and contributes to a coating's photochemical degradation, the type and amount UV radiation emitted from today's QUV weatherometers (ASTM G-53) far exceeds that emitted from natural sunlight. The QUV-B emits UV radiation with a maximum peak at 313 nm (Fig. 6). It also emits some radiation below 295 nm, unlike sunlight, and can be very devastating to some polymer types. Many coatings used on plastics can be quickly destroyed and exhibit cracking and/or significant yellowing in this type of UV exposure. The QUV-A, on the other hand, emits UV light with

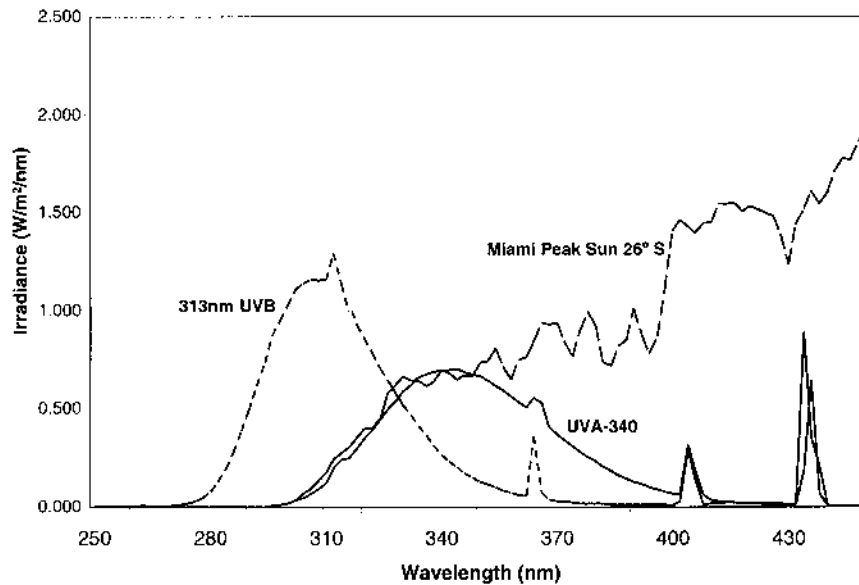

FIG. 6 Fluorescent UV vs. natural sunlight. (Data courtesy of Atlas Material Testing Solutions.)

a peak at 340 nm and has no output below 295 nm, and is also shown in Figure 6. Many coating systems show better correlation between outdoor exposure and QUV-A than with QUV-B.

#### 4.5 Carbon Arc Weatherometer

The carbon arc weatherometer is commonly used (ASTM G-23) and specified by the Japanese OEM companies. The differences between what is emitted from the carbon arc weatherometer and sunlight are very different (Fig. 7). The carbon arc emits higher irradiance in the dangerous 280–310 nm region. Again, chemistry can be induced through exposure in this type of weatherometer that will never occur in the real world. Therefore, the basis for using this type of accelerated weathering device should be based on established durability correlations, and not just on tradition.

#### 4.6 Equatorial Mount with Mirrors for Acceleration Plus Water

Equatorial Mount with Mirrors for Acceleration plus water (EMMAQUA) is a widely underutilized accelerated exposure test (ASTM G-90). An EMMAQUA

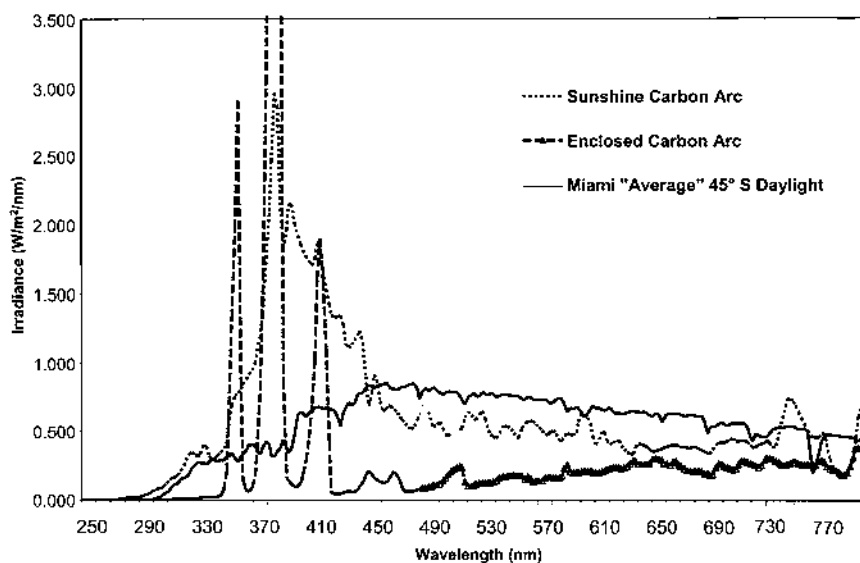

FIG. 7 Carbon arc vs. natural sunlight. (Data courtesy of Atlas Material Testing Solutions.)

exposure in Phoenix, Arizona can enhance the intensity of natural sunlight by a factor of eight, comparable to that with the xenon arc weatherometer. EMMAQUA also can give five times higher UV radiant energy than Southern Florida and its UV output exceeds the xenon weatherometer (Fig. 8). EMMAQUA exposes samples to the full spectrum of natural concentrated sunlight and is therefore, one of the most realistic accelerated weathering tests available and is vastly underutilized.

#### 4.7 Chemical Test Methodology

Researchers like Gerlock (50) and Bauer (51,52), have spent many years trying to understand chemically how coatings break down and what test methods can induce the same chemistry to decompose these automotive coatings. They have focused on the concept of photooxidation and the use of ultraviolet absorbers (UVA) and hindered amine light stabilizers (HALS) to reduce or inhibit the rate of photooxidation (53). They have also developed test methods to produce, observe, and characterize photooxidation degradation products (54). They have also integrated other available nonphotochemical techniques such as liquid chromatography and mass spectroscopy (55) to characterize various photoproducts and suggest reaction mechanisms. Examining Florida-exposed panels using photo-



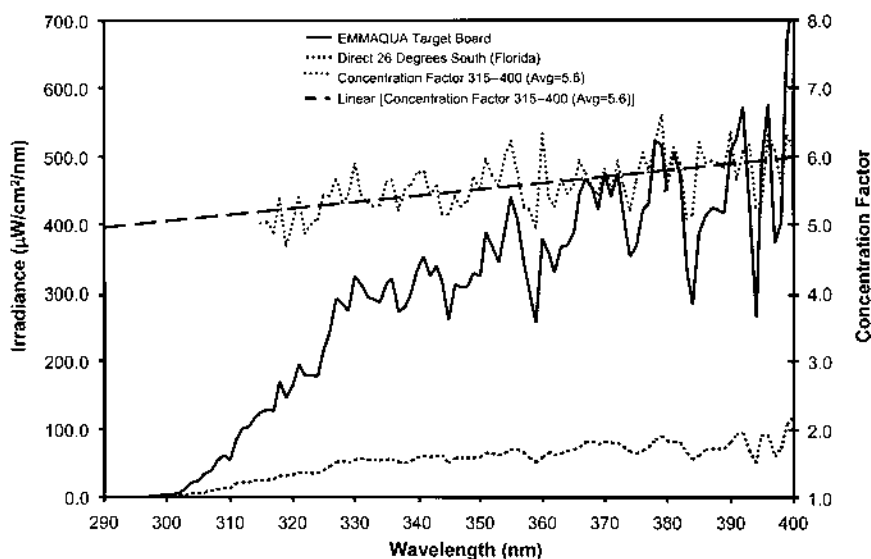

FIG. 8 Emmaqua vs. natural sunlight (UV). (Data courtesy of Atlas Material Testing Solutions.)

acoustic ultraviolet (PAS-UV) and photoacoustic Fourier transform infrared (PAS-FTIR) analysis (56) has proved useful and has provided information on the rates of photooxidation of various UV screeners in combination with HALS.

Researchers continue to develop and gather data from these scientific test methods and correlate these findings with that obtained from real-world exposure. The goal is to perform the exact type of chemistry on coated panels in the laboratory and induce the same type of chemical degradation that results from exposure, in a very short time. An excellent summary on the use of these nontraditional tests and their correlation with Florida exposure has recently been reported by Gerlock et al. (57). These authors propose adding these nontraditional tests to the repertoire of paint-weathering performance metrics. Adding these tests and having the concept accepted by the entire OEM community, would allow the screening and rapid introduction of new durable coatings with the needed and expected performance.

## 5 SUBSTRATE IMPACT

Many people do not realize that the choice of the plastic substrate can have a profound impact on many of the physical, chemical, and mechanical properties

of the painted plastic part. Table 6 shows a comparison of the main substrates for automotive fascia in terms of acceptance, cost, and processing. Because most plastics are nonconductive, some sort of conductive layer is needed to maximize the transfer of paint from a gun to the part. The higher transfer of paint to a conductive part will be evident in the final finish, which continues to improve when additional paint is applied to the part.

### 5.1 Appearance

The use of conductive paints and/or conductive plastics (58) has been shown to enhance paint transfer and can greatly improve painted-part appearance. The impact on appearance is easily seen when one examines porous plastics such as SMC (59) that can be cured at low or high temperatures or plastics containing high amounts of fillers such as milled glass. Rigid RIM (RRIM) containing 15 to 25% glass used to be a popular choice because it offered the desired mechanical properties when painted. However, the presence of the glass resulted in a very rough and porous surface in which glass fibers could protrude through the paint reducing the DOI and gloss. The move to smooth plastics such as TPO gave most of the desired mechanical properties but did not suffer from the loss of DOI when painted. Table 7 shows the impact of substrate type and clearcoat chemistry on painted-part appearance. Table 8 shows some data for these substrates after 24-months of Florida exposure. Yellowing of the coating can also result from the choice of plastic (60) and must be fully evaluated.

**TABLE 6** Comparison of the Main Substrates for Automotive Fascia

| Substrate                       | RIM    | RRIM      | TPO                |
|---------------------------------|--------|-----------|--------------------|
| Relative cost                   | \$\$   | \$\$\$    | \$                 |
| Smoothness                      | Smooth | Rough     | Smooth             |
| Contains IMR                    | Yes    | Yes       | No                 |
| Surface tension                 | High   | High      | Low                |
| Contains filler for stability   | None   | Yes       | Maybe              |
| Migrating materials             | Yes    | Yes       | Yes                |
| Paint adheres directly          | Yes    | Yes       | Not commercial yet |
| Offers class A appearance       | Yes    | Sometimes | Yes                |
| Can yellow topcoat              | Yes    | Yes       | Usually not        |
| Cure requires 250°F             | No     | No        | Yes                |
| Reduces orange peel and DOI     | Low    | High      | Very low           |
| Required primer (usually baked) | Yes    | Yes       | No                 |

**TABLE 7** Effect of Substrate Type and Clearcoat Chemistry on Painted Part Appearance

| Clearcoat technology | Initial gloss |          | Initial DOI |          |
|----------------------|---------------|----------|-------------|----------|
|                      | 1K Flex       | 2K Clear | 1K Flex     | 2K Clear |
| <i>Substrate</i>     |               |          |             |          |
| Metal                | 92            | 87       | 82          | 82       |
| Bexloy V 978         | 91            | 87       | 81          | 80       |
| Noryl GTX 910        | 92            | 86       | 81          | 80       |
| PUR RIM              | 66            | 86       | 72          | 78       |
| PUR RRIM             | 82            | 85       | 69          | 75       |
| PU RIM               | 84            | 85       | 80          | 78       |
| PU RRIM              | 81            | 83       | 71          | 74       |
| TPO                  | 92            | 87       | 81          | 83       |

(1) Basecoat color was light sapphire blue metallic; (2) all substrates were primed with a black flexible primer and baked for 20 minutes at 250°F; and (3) basecoat was applied at 0.7 mil and clearcoat at 1.5 mil. Topcoat was baked for 25 minutes at 250°F.

**TABLE 8** Effect of Substrate Type and Clearcoat Chemistry on Appearance Retention

| Clearcoat technology | Twenty-four months Florida exposure |          |          |                 |          |          |
|----------------------|-------------------------------------|----------|----------|-----------------|----------|----------|
|                      | % Gloss retention                   |          |          | % DOI retention |          |          |
|                      | 1K Flex                             | 1K Rigid | 2K Clear | 1K Flex         | 1K Rigid | 2K Clear |
| <i>Substrate</i>     |                                     |          |          |                 |          |          |
| Metal                | 72                                  | 100      | 99       | 41              | 72       | 112      |
| Bexloy V 978         | 60                                  | 100      | 98       | 63              | 60       | 120      |
| Noryl GTX 910        | 60                                  | 100      | 100      | 81              | 60       | 136      |
| PUR RIM              | 66                                  | 100      | 94       | 25              | 66       | 124      |
| PUR RRIM             | 82                                  | 100      | 94       | 52              | 82       | 89       |
| PU RRIM              | 59                                  | 100      | 93       | 77              | 59       | 113      |
| PU RRIM              | 96                                  | 100      | 92       | 53              | 96       | 109      |
| TPO                  | 88                                  | 99       | 99       | 61              | 88       | 111      |

(1) Basecoat color was light sapphire blue metallic; (2) all substrates were primed with a black flexible primer and baked for 20 minutes at 250°F; (3) basecoat was applied at 0.7 mil and clearcoat at 1.5 mil. Topcoat was baked for 25 minutes at 250°F (part temperature); and (4) panels were exposed 5 degree south (black box) starting in August 1992 for 24 months.

## 5.2 Adhesion

Obviously, not all plastics when coated provide similar adhesive strength. Some can in fact be extremely difficult to adhere to and considerable experience and effort are required to develop robust coatings that will adhere under a wide variety of conditions. As stated in Section 2.2, the surface energy and available bonding sites on or near the surface both contribute to the observed adhesive characteristics. Both of these can be greatly altered through processing (61). The ease with which solvents can penetrate into the plastic will also affect the adhesive strength. Solvent selection can have a major influence on swelling the plastic. In addition, the choice of resin, crosslinker, solvents, and wetting agents can and will affect the amount of adhesion. The selection and even the development of new test methods such as compressive shear delamination (62) and the 90° peel test method (63) will continue to provide information on how to increase the adhesion of paint to a plastic substrate.

## 5.3 Gasoline Resistance

The gasoline resistance of coated TPO is dramatically affected by the type and grade of TPO. Coating systems that perform well on low modulus TPO can completely delaminate from higher modulus grades. As previously stated, stronger adhesive formulations are needed to give the expected performance on these higher modulus grades of TPO (Fig. 9).

## 5.4 Gouging

Gouging of plastic arose with the introduction of soft plastics like TPO. Operators who would roughly handle TPO parts and bang them together would gouge the plastic, giving painted defects known as black scratches. This weakness made it rather difficult to successfully paint TPO and give the desired appearance without any defect. Over time, paint operators began to handle the soft substrate with a little more care and completely eliminated in-plant damage. The cohesive weakness of conventional TPO did not improve when painted and the part would still gouge when painted. This area has been extensively studied by Ryntz in terms of TPO morphology and the type of coatings used. While not recognized as a large warranty issue, TPO gouging is fairly prevalent on today's automotive bumpers and greatly detracts from the painted part appearance. Many TPO suppliers continue to try and increase TPO's cohesive strength in an attempt to reduce this unsightly part defect. As previously stated, the shift to higher modulus materials can significantly reduce the severity and prevalence of friction-induced gouge damage.

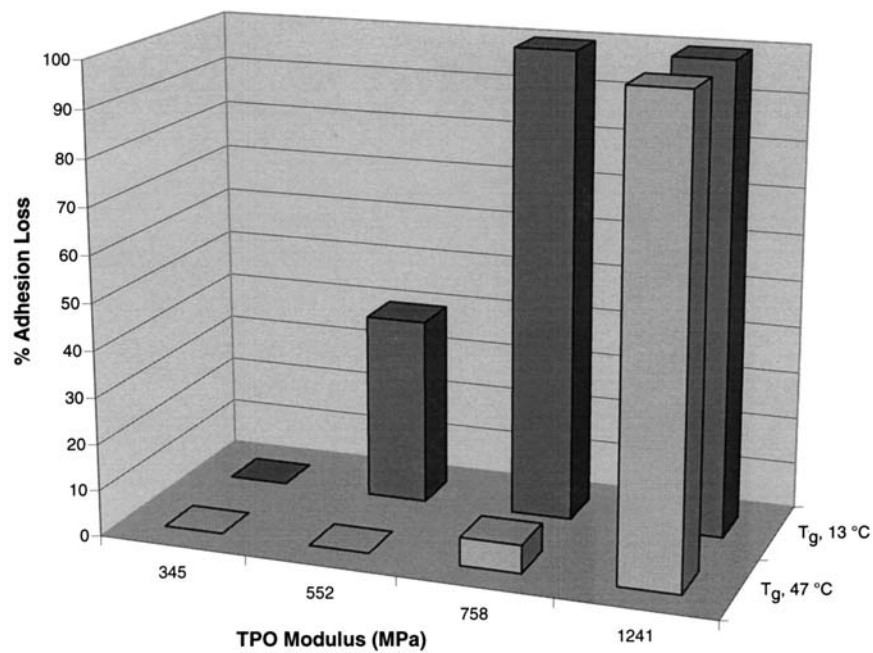

FIG. 9 Impact of TPO modulus on gasoline soak.

### 5.5 Chipping

For the most part, chipping is not very evident on today's painted parts. The combination of flexible plastic and flexible paint largely overcomes the tendency to chip, even at low temperatures. However, with the trend to higher modulus materials, chipping could become an issue. Here again, it is critical to test the entire painted part system, prior to any change or a new commercialization.

### 5.6 Flexibility and Impact Resistance

This is the area where plastic plays a tremendous role in determining painted part performance. The closer the match in flexibility of the plastic part with that of the coating used, the better the probability of meeting the expected low-temperature flexibility and impact performance. For many years, the flexibility of a painted part was accessed through a mandrel bend test. More recently, the importance of this test has diminished and has been replaced with the multiaxial impact test, usually performed at low temperatures. Failure in this test occurs

when the falling dart induces brittle failure (i.e., part cracks), as opposed to ductile failure (i.e., paint cracks).

The trend to thinner-walled, higher modulus TPO diminishes these impact properties, especially at low temperatures. This movement also reduces the window for acceptable flexibility as shown in Figure 10. According to Figure 10, higher modulus TPO is more sensitive to variation in bake time and temperature and as such, closer control of oven conditions are needed to ensure the required flexibility specifications will be met. To avoid shatter or breakage of the painted plastic part, the coating must be made more flexible as the substrate becomes more rigid, to keep the same low-temperature performance. Unfortunately, properties such as chemical resistance are reduced with the move to more flexible coatings. The use of more flexible resins and/or more flexible crosslinkers can be used as approaches that may help to increase a coating's flexibility and, ultimately, impact resistance.

### 5.7 Scratch and Mar

While not dramatic, plastic selection can influence the degree of scratch-and-mar damage of a painted part. In many instances, a coating will be softer when applied to a soft plastic surface. On the other hand, applying it to an unusually hard plastic surface will render the coating slightly harder. In some respect, the coating telegraphs the hardness of the surface and takes on some of its characteristic. Because flexible coatings have better mar resistance than rigid coatings,

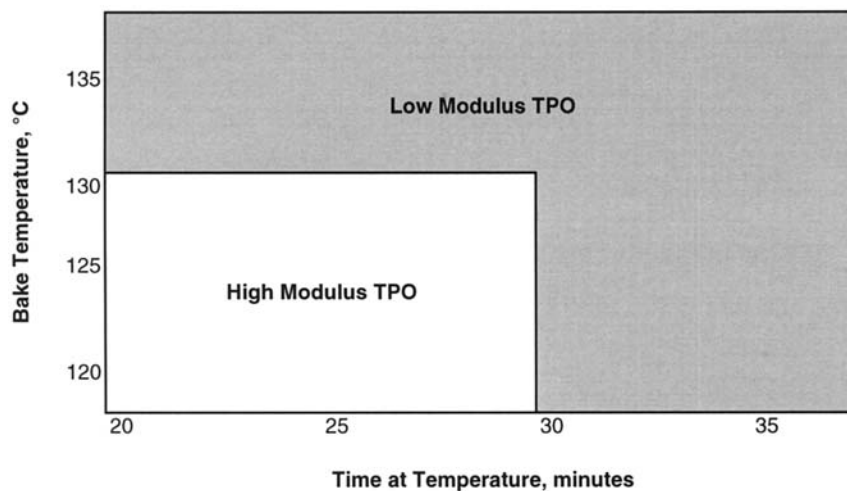

Fig. 10 Impact of TPO modulus on painted part flexibility window.

applying a flexible coating to a rigid surface will make the surface scratch less.

### 5.8 Etch and Chemical Resistance

The choice of substrate can impact the chemical and etch resistance of a coated plastic part. Thin layers of paint (especially when thin) can be influenced by the hardness of the substrate. However, this does not generally impact the chemical resistance of clear-coated parts as measured in testing such as Jacksonville. Substrates that are sensitive to solvents such as acrylonitrile butadiene styrene (ABS) and polycarbonate/polybutylene terephthalate (PC/PBT) can be rapidly or slowly degraded when attacked with certain solvents or even basic materials.

## 6 PAINT TECHNOLOGY IMPACT

Obviously, the choice of substrate, the molding process, the paint technology used, how the parts were painted, and the particular paints selected can have a major impact on both performance of the painted plastic part and durability. Figure 11 illustrates on a relative basis the impact each of these variables can have on durability. In this particular example, durability was considered as appearance retention. The movement from the early mono-coat technology to the current basecoat/clearcoat technology has markedly improved both the performance and durability of the coated plastic part. Specifications for OEMs have increased tremendously thus dictating the need for higher durability products.

### 6.1 Adhesion Promoters and Primers

The use of a primer to promote adhesion and fill in voids in the substrate can help to improve part appearance and quality. The use of adhesion promoters on olefinic substrates such as TPO and PP not only is necessary for adhesion but also dramatically influences other properties such as gasoline, gasohol, and even gouge resistance. Adhesion promoters for TPO and polypropylene (PP) are commonly chlorinated based polyolefin (CPO) primers (64) that contain a co-resin, conductive carbon black, and hydrocarbon solvents for optimum CPO solubility. Other resins can also be beneficial in improving adhesion especially under humidity conditions (65).

Both solventborne and waterborne (66) CPOs are available and both can be formulated into products meeting today's needs. Chlorine-free waterborne adhesion promoters based on maleic anhydride grafted propylene-hexene copolymer have also been developed and exhibit excellent adhesion and gasoline resistance (67).

Specifications for painted TPO parts have become more stringent over the past decade forcing the need to control the film build of the adhesion promoter. Applying the adhesion promoter at 5 to 10 microns is necessary to ensure good

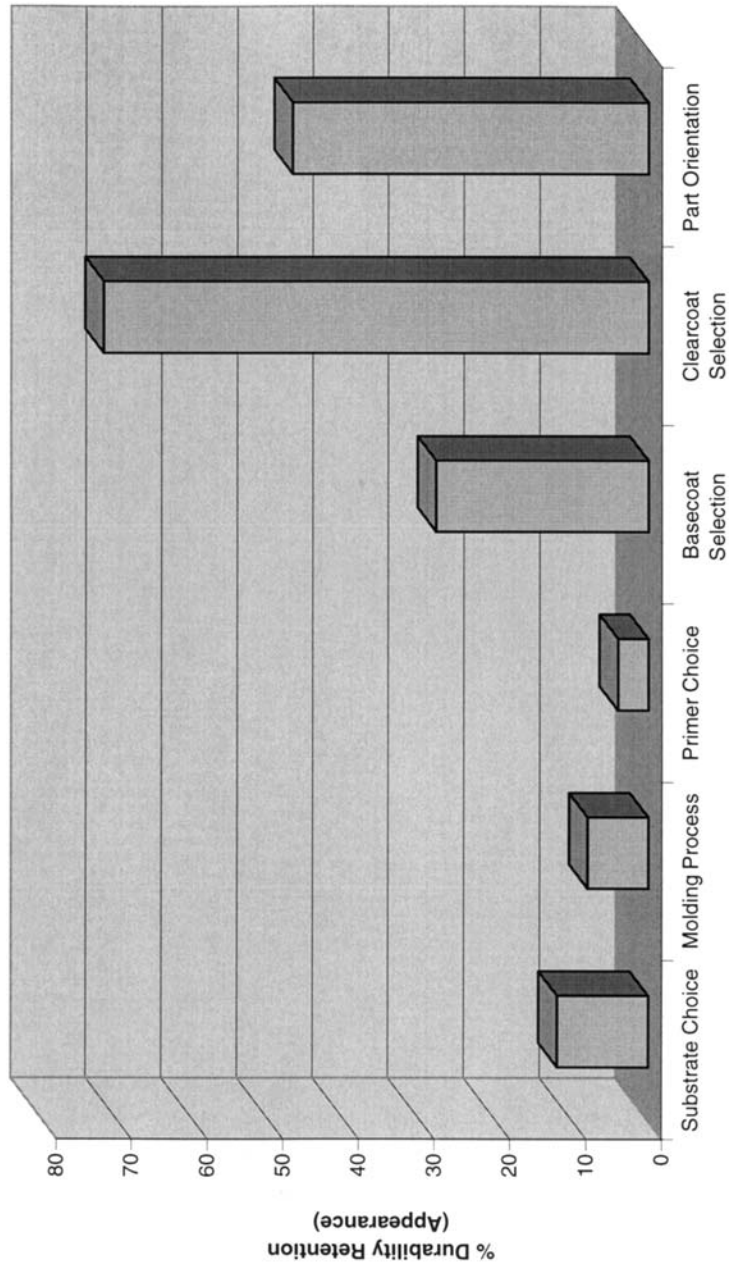

FIG. 11 Impact of substrate, processing, and paint technology on durability retention.



adhesion, whereas applying it at a thickness greater than 15 microns, can lead to cohesive failure within the adhesion promoter layer. The utilization of experimental tools such as Time-of-Flight Secondary Ion Mass Spectroscopic (TOF-SIMS) and fluorescent microscopy of labeled CPO (68) has led to the finding that the CPO distributes itself within the top few microns of the TPO surface and that the solvent composition of the adhesion promoter strongly influences this. In some cases, CPO alone is not enough to ensure adequate adhesion to a particular grade of TPO and auxiliary resins will be needed. Some polyolefin diols (69) can be reacted with melamine to produce resins that can adhere directly to TPO and increase CPO adhesion.

Primers for higher surface energy plastics like RRIM and SMC are usually of the polyester-melamine type. They usually contain flattener, filler, pigment, and, if they will be exposed, UV fortification. Conductive carbon black is added to enhance the electrostatic attraction to the plastic part and quickly dissipate any accumulated electrostatic charge (70,71). High electrical properties for both adhesion promoters and primers are needed to optimize the paint's application to the plastic part and the subsequent topcoat. Measurement of the paint's electrical conductivity is crucial to optimize paint application performance including both the amount of coverage and wrap. The highest electrical conductivity of a paint film (or lowest resistivity) is achieved at the critical pigment volume concentration (CPVC) of the conductive pigment in the primer formulation (72). When higher durability is needed or heat-sensitive plastics are used, then 2K primers are used in which the melamine-formaldehyde crosslinker is basically replaced by isocyanate to gain the level of cure needed at the lower temperature. However, 2K primers with high PVC carbon black content can consume isocyanate and exhibit weaker adhesion on substrates such as ABS (73).

One of the primer formulating challenges is the balance of physical properties and cure after the primer bake cycle, especially when the product is considered a weatherable primer. In that case, the primer needs to be designed to have out-of-oven properties so that it is hard enough so that it can be sanded prior to repainting and pass the required humidity, solvent-resistance, and humidity-adhesion testing. In addition, the primer must be able to accept topcoat and ensure good adhesion of the system after two bake cycles even though the type of bake oven environment can dramatically influence adhesion of topcoat (74). Of course, this is a nonissue for primers painted wet-on-wet with the topcoat. Many attempts to formulate primers with the needed out-of-oven properties can exhibit adhesion loss when topcoated. Careful selection of crosslinker and filler can usually overcome this potential adhesion loss, even when the primer is severely overbaked.

## 6.2 Basecoats

Basecoat selection can influence finished part quality mostly through its selection of crosslinker. Some simple solventborne basecoats may be of the lacquer

type and do not contain any additional crosslinker. Typically one-component (melamine-cured) basecoats require 121°C to fully cure whereas two-component (usually isocyanate-cured) basecoats only require 75 to 82°C. Pigment differences can lead to dramatic differences between colors. Some pigments have been surface treated and can contain acidic or basic groups that can alter the degree of cure when external catalysts are used. Also the hiding properties of the individual pigment can determine the amount of pigment needed to attain the required color. Higher pigment to binder (P/B) coatings can exhibit undesirable issues that may not be seen with low P/B colors. It is important for the formulator to understand the pigment contribution to film properties and performance and only rely solely on the pigmentation offered from color development personnel. A computer simulation capturing the physical aspects of film and surface appearance changes during weathering has been developed relating pigment PVC to gloss loss (75).

Waterborne basecoats are predominantly 1K in nature and will not be discussed here as they are extensively dealt with elsewhere (see Chapter 10). The 2K waterborne basecoat technologies (76,77) are now available for use when needed and offer many of the advantages of 2K coatings, with the environmental friendliness of water.

### 6.3 Clearcoats

In a basecoat/clearcoat system, the choice of clearcoat will have the largest influence on properties and performance. Careful selection of backbone resin, crosslinker, and even additives is crucial to ensure the production of high-quality painted parts. Fortunately, a strong clearcoat can overcome or even hide a weak basecoat. Light stabilizer additives can greatly determine the properties and durability of a painted part and will be discussed in more detail.

#### 6.3.1 Light Stabilizer Selection

The choice of UVAs and HALS in the coating are crucial to ensure painted part longevity. Because many automotive plastics are only partially painted, light stabilizers are also used in the plastic (78,79) and these stabilizers can impact the performance and properties of the painted part. When selecting UVAs, the formulator must consider not only the UVA molar extinction coefficient, but include other features such as its molecular weight and temperature volatility, photochemical stability, solvent solubility, and, most importantly, its compatibility with the other paint ingredients in the coating (80,81). Light stabilizers that work exceedingly well in one coating system, may cause unwanted effects such as visible bloom due to an incompatibility, poor performance due to a cure inhibition, especially with acid catalyzed coatings, or even yellowing. Cure inhi-

bition is especially important when dealing with HALS additives because many by design have basic functional groups.

Many approaches are available to screen the effectiveness of light stabilizers in a particular paint system and to determine how much is needed to meet the customer need. Obviously, the amount needed will vary accordingly to the resin and crosslinker used, but in general 1.5 to 2% UVA and 1% HALS (80) can achieve much of the stabilization required when used together. Laddering the additives in basecoat/clearcoat formulations using both pigmented and unpigmented basecoats is an effective way to quickly screen what additives may be helpful and what role basecoat pigments may play. Haake (82) has shown that certain pigments in the basecoat, especially organic reds can attract HALS from the clearcoat, reducing the amount available to protect the clearcoat. In addition, exposing panels at low film build will lead to premature failure and can be helpful in screening various stabilizers for their effectiveness in the field.

The high degree of UVA migration in coatings over plastic, especially into the plastic substrate (83) has led to much research activity in this area. For example, microtoming and analytical measuring of the paint layers from the top down can provide valuable information on the loss and/or movement of light stabilizers throughout the curing process (84) and establish which are the best additives for a particular system. In this work, Haake and co-workers found the viscosity of the thermosetting resin largely determined the amount of additive migration. They also found that in two-layer coatings, solvent penetration and swelling of an adjacent layer that was partially cured can enhance stabilizer migration. These findings have led to development of polymer-bound light stabilizers (85). The advantage of these materials is that they contain some OH functionality and can be readily crosslinked into the resin system. Both polymer-bound UVA and polymer-bound HALS additives are available and should gain more commercial use as paint formulators try to approach the ten-year durability desired from the OEMs.

### 6.3.2 One Component

In automotive coatings, one-component (1K) coatings using melamine formaldehyde (MF) crosslinkers have been the dominant technology used for automotive plastics since the advent of basecoat/clearcoat in the early 1980s. While initial products used polymeric MF resins and were typically 40 to 50% solids (high NH or partially alkylated), the recent trend has been to higher solids (60%+) using more monomeric (fully alkylated) MF crosslinkers. The movement to these lower viscosity, fully alkylated higher solid MF resins has resulted in clearcoats that are more sensitive to external contaminants and a more judicious selection of solvents, to give a wide application window, is required (86). Table 9 shows the expected film attribute comparison between selecting a fully alkyl-

**TABLE 9** Comparison of Monomeric (Highly Alkylated) vs. High NH Amino Resins

| Attribute                  | Highly alkylated | High NH |
|----------------------------|------------------|---------|
| Compatibility              | +                |         |
| VOC                        | +                |         |
| Free formaldehyde          | +                |         |
| Film flexibility           | +                |         |
| Mar resistance             | +                |         |
| Hydrolysis resistance      | +                |         |
| Etch resistance            | +                | +       |
| Film hardness              |                  | +       |
| 2K cure response           | +                |         |
| Formulation stability      | +                |         |
| Buffered cure response     |                  | +       |
| Cure in 1K waterborne      |                  | +       |
| Stability in 1K waterborne | +                |         |
| Telegraphing resistance    |                  | +       |
| Fuming tendency            |                  | +       |
| Formaldehyde emission      |                  | +       |

Source: Ref. 85.

ated versus a high NH amino resin as a crosslinker in terms of network development, self-condensation tendency, and catalysis.

One-component flexible clears usually are comprised of a polyester resin and/or an acrylic backbone that is crosslinked with a MF resin. Various rheologically active resins or additives are used to provide the needed sag and appearance on vertical surfaces. Other additives such as light stabilizers, acid catalysts, and surface tension modifiers to control appearance and reduce defects are also added. The formulator constantly has to be aware of all the ingredients in the formulation because ingredients such as amine blockers that stabilize sulfonic acids, can significantly affect film properties and performance (87). Development of a robust cure window (88) allows 1K melamine crosslinked coatings to be used on many customer lines and provide acceptable cure under a wide variety of conditions. These 1K coatings can offer excellent appearance, chip, and flexibility with very good two- to three-years Florida durability at fairly low cost. However, due to an ether linkage that is readily hydrolysable, environmental etch performance is very poor (89). Improvements in acid etch has been noted through UV treatment of conventional MF clearcoats (90), but this technology has not become very popular.

As OEMs continue to increase their durability requirements, traditional 1K clearcoats are being upgraded with additional or auxiliary crosslinkers. To

this end, 1K flexible carbamate (91,92) and flexible silane (93) crosslinked coatings have been introduced on the market. Coatings with higher silane levels (94) can exhibit even further improved mar-and-abrasion resistance, with a lower coefficient of friction, but at higher cost. Both these clearcoat technologies are compatible with current basecoats and offer many of the 2K attributes in a one-component package.

Table 10 shows the attribute comparison of 1K melamine crosslinked clearcoats as compared to 2K isocyanate crosslinked clearcoats. Figure 12 graphically shows selected attributes from this comparison. Blocked isocyanate clearcoats also exist, but these are not very common over plastic substrates presumably due to the higher temperatures needed to cause the unblocking (95). On the other hand, the use of low imino, methylated melamine resins (96) can provide cure at temperatures as low as 82°C, opening up the opportunity for use on heat-sensitive substrates.

### 6.3.3 Two Component

Two-component (2K) clearcoats have been considered the industry “gold standard” since their introduction on automotive plastic parts in the early 1990s.

**TABLE 10** Clearcoat Technologies for Plastics Attribute Comparison

| Property                              | 1K Melamine flexible clear | 2K isocyanate clear for plastics |
|---------------------------------------|----------------------------|----------------------------------|
| Glass transition temperature, $T_g$   | Low                        | Higher                           |
| Initial appearance                    | Good                       | Excellent                        |
| % Flexibility <sup>a</sup>            |                            |                                  |
| 23°C                                  | >20                        | >20                              |
| -30°C                                 | 5 to 8                     | 2 to 5                           |
| Scratch resistance, % gloss retention | 90-95                      | 70-85                            |
| Gouge resistance                      | Good to very good          | Excellent                        |
| Impact resistance, -15°C <sup>a</sup> | Excellent                  | Good to excellent                |
| Stain resistance                      | Poor to good               | Very good to excellent           |
| Jacksonville etch rating, 0 = best    | 10 to 12                   | 5 to 7                           |
| Xenon weathering, % retention         |                            |                                  |
| 2500 KJ                               | 80 to 95                   | 95 to 100                        |
| 3500 KJ                               | 65 to 85                   | 80 to 95                         |
| % appearance retention, Florida       |                            |                                  |
| 12 months                             | 86-94                      | 96+                              |
| 24 Months                             | 68-82                      | 94+                              |
| 36 Months                             | 56-68                      | 86+                              |
| 48 Months                             | 36-58                      | 80+                              |

<sup>a</sup>Influenced by substrate flexural modulus.

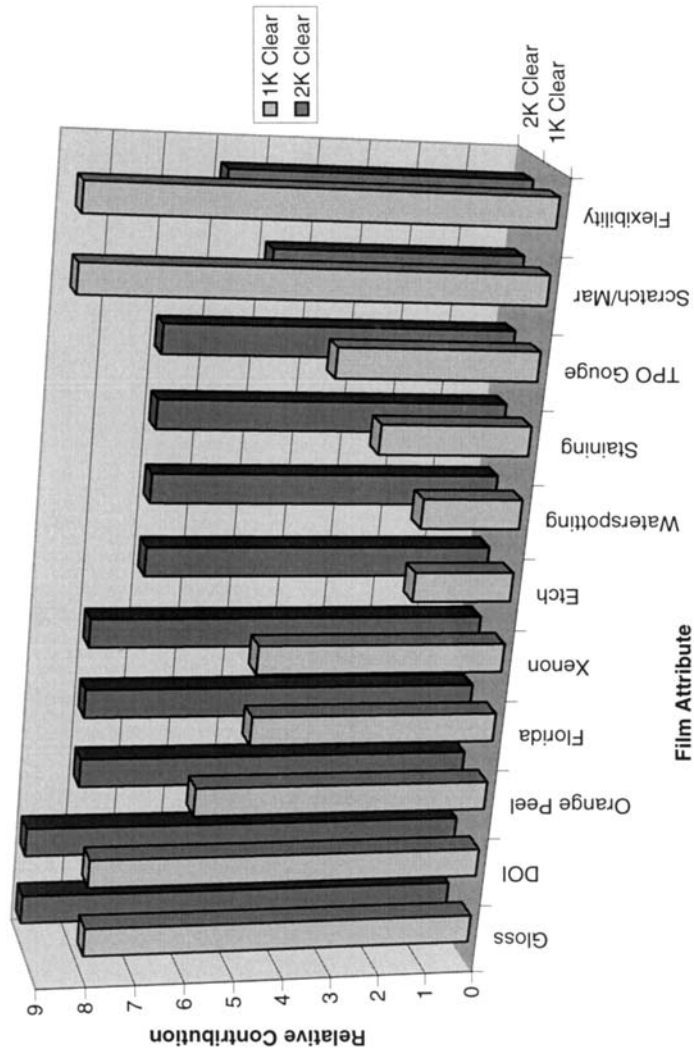

Fig. 12 Comparison of 1K melamine vs. 2K isocyanate clearcoats for film attributes.

Their outstanding performance and durability, due to the urethane functional isocyanate crosslinker, has been responsible for their widespread use, especially on premium parts and vehicles. The isocyanate group has the advantage that it can crosslink with moisture at low temperature. This can help oven-baked 2K coatings continue to crosslink even after being removed from the oven. According to infrared data, many 2K systems only consume 60 to 70% of the available isocyanate in the oven and require 10 to 14 days to develop full properties.

Isocyanates can also undergo a wide variety of primary reactions. For example, they can react with alcohols to form urethanes and react with amines to give ureas. Isocyanates can also undergo secondary reactions reacting with urethanes and ureas to give allophanates and biurets, respectively. Isocyanates can also release carbon dioxide that can appear as small bubbles or micropopping in the clearcoat film. The use of moisture scavengers and other additives can help reduce or completely eliminate these defects in baked systems.

For automotive applications, both low-bake (80 to 90°C) and high-bake (120 to 130°C) 2K clearcoats are in use today. Most 2K coatings for plastics use aliphatic hexamethylene diisocyanate (HDI) as its film properties exhibit a good combination of flexibility and durability, and reasonably fast reactivity. For some applications, blending in some isophorone diisocyanate (IPDI) or biuret is used to increase surface hardness or produce softer, more flexible films. The choice of catalyst, temperature, and alcohol can dramatically influence the composition of the final product, especially when IPDI is used (97). There is little use of aromatic diisocyanates such as toluene diisocyanate (TDI) or methylene diphenyl diisocyanate (MDI) due to their high contribution of yellowing. In general, the addition of a small amount of catalyst is enough to induce cure of the high-bake coating at lower temperature. The strongest catalysts are materials such as mercuric compounds, tin (IV) compounds, zinc (II) carboxylates, tertiary amines, and carboxylic acids (98). In cases where the resin does not cure fast enough, more reactive, faster curing materials can be used.

Two-component clearcoats are resistant to attack by acid and base and as such can offer very good resistance to acid rain, chemicals, solvents, and road contaminants such as tar, oil, and even asphalt. In cases where appearance and durability requirements are demanding, 2K clearcoats can perform well. It is quite normal to see 80 to 90% gloss retention after five years of Florida black-box exposure with 2K coatings.

## 7 CONCLUSIONS AND FUTURE

It is evident that the OEM industry desires ten-year durable coatings. As the OEMs continue to increase the test severity and increase the amount of testing required to fully qualify new plastics and coatings, it will take considerably

longer to introduce these changes. The requirement of multiyear Florida exposure panels highlights the need for a test protocol that will accurately predict the long-term durability of a particular system in a relatively short time frame. Moreover, any adopted technique must be accepted by all OEMs as being representative of real-world exposure, or it will only be considered indicative and not a true replacement for the long-term testing.

The coating of plastic parts will continue as long as the process remains cost effective relative to other decorating options. To this end, some OEM stylists have chosen to specify molded-in-color plastics, especially for sport utility and lower-priced vehicles. The use of partially painted plastic parts is also becoming more prevalent, but brings with it potential problems with demasking and adhesion. Alternate decoration processing methods will continue to be explored in an attempt to eliminate a step and reduce cost. Fully paintable conductive TPO may be the process of choice for the economical painting of TPO bumpers. Topcoats adhering directly to TPO, without the use of any form of adhesion pretreatment or adhesion promoter may appear in limited applications. The widespread use of this technology with the multitude of plastics available on the market and colors available may turn into a logistical nightmare.

Although not discussed in this chapter, changes in solvent composition will shift to be more ecologically friendly. Conversion to fully compliant hazardous air pollutant solvents (HAPS) will require complete reformulation of most coating resins. Free solvent replacement to HAPS compliant can occur immediately and substitution in all manufactured resins should be fully implemented within the next few years. Greater use of waterborne materials (primers, basecoats, and clears) is expected within the next five to ten years as long as application properties, performance, and durability can be attained.

## REFERENCES

1. PV Yanef. Examining the Appearance and Durability of Painted Automotive Plastics. Paint and Coatings Industry. Troy, MI: Business News Publishing, June 1998, pp 60–74.
2. PE Pierce, CK Schoff. Coating Film Defects, Federation of Societies for Coatings Technology, Monograph Series, Philadelphia, 1988, pp 14–17.
3. RHJ Blunk, JO Wilkes. Surface-tension-driven flows of coatings: Bondline readout formation. *J Coatings Technology* 73(918):63–71, 2001.
4. JA Baghdachi. Adhesion Aspects of Polymeric Coatings, Federation of Societies for Coatings and Technology Monograph Series, Philadelphia, 1998, pp 7–23.
5. RA Ryntz. Adhesion to Plastics-Molding and Paintability. Global Press, USA, 1998, pp 95–101.
6. C Schoff. Wetting and wettability in the painting of plastics. Proceedings of the Fourth International Coatings for Plastics Symposium, Troy, MI, 2001.



7. J Cremers. DSM mechanical peel test. Conference Proceedings, TPOs in Automotive, Novi, MI, 1997.
8. RA Ryntz, D Britz, DM Mihora, R Pierce. Measuring adhesion to poly(olefins): The role of adhesion promoter and substrate. *J Coatings Technology* 73(921):107–115, 2001.
9. R Ryntz, M Everson, G Pollano. Friction induced paint damage as affected by clearcoat chemistry. Proceedings of Twenty-Fourth International Waterborne, High-Solid, and Powder Coatings Symposium, New Orleans, 1997, pp 259–276.
10. EW Orr. Performance Enhancement in Coatings. Cincinnati: Hanser Publishers, 1998, pp 126–128.
11. RA Ryntz, AC Ramamurthy, DJ Mihora. Thermal and impact induced stress failure in painted TPO: The role of surface morphology. *J Coatings Technology* 67(840): 35–46, 1995.
12. RA Ryntz, AC Ramamurthy, JW Holubka. Stone impact damage to painted plastic substrates. *J Coatings Technology* 67(842):23–31, 1995.
13. ZW Wicks Jr., FN Jones, SP Pappas. *Organic Coatings: Science and Technology*. New York: John Wiley and Sons, 1994, pp 112–118.
14. K Adamsons, RJ Barsotti, L Lin, BV Gregorovich, P McGonigal, B Neff, G Blackburn, D Nordstrom, J Johnson. Scratch and mar testing: General issues and application of the single nano-indenter micro-scratch technique in the study of newly prepared and aged clearcoats. Conference Proceedings of Advanced Coatings Technology, Detroit, 1997, pp 191–214.
15. W Shen, B Jiang, FN Jones. Measurement of mar resistance and study of the mar-ring mechanism of polymeric coatings with scanning probe microscope. *J Coatings Technology* 72(907):89–95, 2000.
16. JL Courter. Mar resistance of automotive coatings: I. Relationship to coating mechanical properties. *J Coatings Technology* 69(866):57–63, 1997.
17. FN Jones. Mar resistance of coatings. Proceedings of the First International Coatings for Plastics Symposium, Troy, MI, 1998.
18. V Jardet, BN Lucas, W Oliver, AC Ramamurthy. Scratch durability of automotive clear coatings: A qualitative, reliable and robust methodology. *J Coatings Technology* 72(907):79–88, 2000.
19. BV Gregorovich, PJ McGonigal. Mechanical properties of coatings needed for good scratch and mar. Proceedings of the Advanced Technology Conference, Materials Park, OH, 1992, pp 121–125.
20. RA Ryntz, GM Pollano. Scratch resistance of model coating systems. *J Coatings Technology* 72(904):47–53, 2000.
21. PB Jacobs, T Engbert. Scratch and mar resistance of polyurethane automotive clearcoats. Proceedings of the Advanced Coatings Technology Conference, Detroit, 1995, pp 29–39.
22. PV Yaneff, K Adamsons, RA Ryntz, D Britz. Structure property relationships in flexible silane automotive coatings, Proceedings of Twenty-Eighth International Waterborne, High-Solid, and Powder Coatings Symposium, New Orleans, 2001, pp 109–125.
23. K Adamsons, RJ Barsotti, L Lin, BV Gregorovich, P McGonigal, B Neff, G Black-

- burn, D Nordstrom, J Johnson. Scratch and mar testing: General issues and application of the single nano-indenter micro-scratch technique in the study of newly prepared and aged clearcoats. Conference Proceedings of Advanced Coatings Technology, Detroit, 1997, pp 191–214.
24. F Lee, B Pourdeyhimi, K Adamsons. Analysis of coatings appearance and surface defects using digital image capture-processing-analysis system. In: D Bauer, J Martin, eds. *Service Life Prediction of Organic Coatings*. Washington: American Chemical Society, 1999, pp 257–287.
  25. Northwestern Society for Coatings Technology and Montreal Society for Coatings Technology. A study of the effect of acid rain on alkyd, polyester, and silicone-modified high-solids coatings. *J Coatings Technology* 67(850):19–28, 1995.
  26. PJ Schmitz, JW Holubka, L Xu. Acid etch resistance of automotive clearcoats I. Laboratory test method development. *J Coatings Technology* 72(901):77–82, 2000.
  27. PJ Schmitz, JW Holubka, L Xu. Acid etch of automotive clearcoats II. Comparison of degrading chemistry in laboratory and field testing. *J Coatings Technology* 72(902):53–61, 2000.
  28. J McGee, B Bammel. Carbamate-based flexible coatings—a means to improve durability of painted plastic automotive components. Conference Proceedings, TPOs in Automotive, Novi, MI, 1998.
  29. CK Schoff. Mechanical properties of automotive topcoats. Conference Proceedings, Advanced Coatings Technology, Detroit, 1994, pp 61–78.
  30. LW Hill. Mechanical Properties of Coatings. Federation of Societies for Coatings Technology. Monograph Series, Philadelphia, 1987, pp 7–23.
  31. LW Hill. Structure/property relationships of thermoset coatings. *J Coatings Technology* 64(808):29–42, 1992.
  32. G Haake, JS Brinen, PJ Larkin. Depth profiling of acrylic/melamine formaldehyde coatings. *J Coatings Technology* 67(843):29–34, 1995.
  33. DY Perera. Role of stress on durability of organic coatings. In: RA Ryntz, ed. *Plastics and Coatings: Durability, Stabilization, Testing*. Cincinnati: Hanser Gardner, 2001, pp 115–119.
  34. LW Hill. Overview of mechanical property changes during coating degradation. In: DR Bauer, JW Martin, eds. *Service Life Prediction of Organic Coatings: A Systems Approach*. ACS Symposium Series 722. New York: Oxford University Press, 1999, pp 312–322.
  35. ME Nichols, CA Darr. The effect of weathering on the stress distribution and mechanical performance of automotive paint systems. In: DR Bauer, JW Martin, eds. *Service Life Prediction of Organic Coatings: A Systems Approach*. ACS Symposium Series 722. New York: Oxford University Press, 1999, pp 332–353.
  36. ME Nichols, CA Darr. Effect of weathering on the stress distribution and mechanical performance of automotive paint systems. *J Coatings Technology* 70(885):141–149, 1998.
  37. DY Perera, M Oosterbrook. Hygrothermal stress evolution during weathering in organic coatings. *J Coatings Technology* 66(833):83–88, 1994.
  38. DR Bauer, JW Martin. *Service Life Prediction of Organic Coatings*. ACS Symposium Series 722. New York: Oxford University Press, 1999.

39. JW Martin, SC Saunders, FL Floyd, JP Wineburg. Methodologies for Predicting the Service Lives of Coating Systems, Federation of Societies for Coatings Technology. Monograph Series, Philadelphia, 1996, pp 7–13.
40. EV Schmid. Exterior Durability of Organic Coatings. Surrey, England: FMJ International Publications Limited, 1988, pp 2–15.
41. L Crawley. Predicting long-term durability of automotive coatings. Conference Proceedings of Advanced Coatings Technology, Detroit, 1993, pp 153–170.
42. ZW Wicks Jr., FN Jones, SP Pappas. Organic Coatings: Science and Technology, Volume II. New York: John Wiley and Sons, 1994, pp 145–148.
43. KM Wernstahl, B Carlsson. Durability assessment of automotive coatings—design and evaluation of accelerated tests. *J Coatings Technology* 69(885):69–75, 1997.
44. G Pilcher, G Van de Streek, J Chess, D Cocuzzi. Accelerated weathering: Science, pseudo-science or superstition? Proceedings from the Research Conference on the Science and Technology of Organic Coatings, Hilton Head, SC, 1998, pp 199–212.
45. G Pilcher, G Van de Streek, J Chess, D Cocuzzi. Accelerated weathering: Science, pseudo-science or superstition? In: Service Life Prediction of Organic Coatings. ACS Symposium Series 722. New York: Oxford University Press, 1999, pp 130–148.
46. CJ Sullivan, CF Cooper. Polyester weatherability: Coupling frontier molecular orbital calculations of oxidative stability with accelerated testing. *J Coatings Technology* 67(847):53–62, 1995.
47. ASTM J1960.
48. D Bauer, J Peck, R Carter III. Evaluation of accelerated weathering tests for a polyester-urethane coating using photoacoustic infrared spectroscopy. *J Coatings Technology* 59:103–107, 1987.
49. SR Smith. Accelerated weathering vs. Florida weathering for automotive coatings on plastics. Proceedings of the Second International Coatings for Plastics Symposium, Troy, MI, 1999.
50. JL Gerlock, CA Smith, VA Cooper, SA Kaberline, TJ Prater, RO Carter III, AV Kucherov, T Misovski, and ME Nichols. A brief review of paint weathering research at Ford. In: Service Life Prediction Methodology and Metrology. ACS Symposium Series 805, Washington, 2002.
51. DR Bauer. Predicting in-service weatherability of automotive coatings: A new approach. *J Coatings Technology* 69(864):85–96, 1997.
52. DR Bauer. Chemical criteria for durable automotive topcoats. *J Coatings Technology* 66(835):57–65, 1994.
53. JL Gerlock, W Tang, MA Dearth, TJ Korniski. Reaction of benzotriazole ultraviolet light absorbers with free radicals. *Polymer Degradation and Stability* 48:121–130, 1995.
54. JL Gerlock, TJ Prater, SL Kaberline, JE deVries. Assessment of photooxidation in multi-layer coating systems by time-of-flight secondary ion mass spectroscopy. *Polymer Degradation and Stability* 47:405–411, 1995.
55. MA Dearth, TJ Korniski, JL Gerlock. The LC/MS/MS characterization of photolysis products of benzotriazole-based ultraviolet absorbers. *Polymer Degradation and Stability* 48:111–120, 1995.

56. JL Gerlock, RO Carter, M Agarwal. Photoacoustic FTIR and UV spectroscopic analysis of clearcoat photooxidation and UVA disposition in Florida test panels. Technical Report No. SR-95-041 Ford Motor Company, 1995.
57. GL Gerlock, AV Kucherov, ME Nichols. On the combined use of UVA, HALS, photooxidation, and fracture energy measurements to anticipate the long-term weathering performance of clearcoat/basecoat automotive paint systems. *J Coatings Technology* 73(918):45–54, 2001.
58. S Babinec, R Lewis, B Cieslinski. Conductively modified TPO for enhanced electrostatic painting. Proceedings of the Fourth International Coatings for Plastics Symposium, Troy, MI, 2001.
59. S Vessot, J Andrieu, P Laurent, J Galy, JF Gerard. Air convective drying and curing of polyurethane-based paints on sheet molding compound surfaces. *J Coatings Technology* 70(882):67–76, 1998.
60. G Faoro. Potential reasons for yellowing of coatings over plastic substrates. Proceedings of the Fourth International Coatings for Plastics Symposium, Troy, MI, 2001.
61. E Nunez. Surface energy measurements on thermoplastic olefins. Conference Proceedings of Advanced Coatings Technology, Detroit, MI, 1993, pp 91–97.
62. R Ryntz, D Britz, D Minhora, R Pierce. Measuring adhesion to poly(olefins): The role of adhesion promoter and substrate. *J Coatings Technology* 73(921):107–115, 2001.
63. D Kondos, M Mayo. Quantitative adhesion testing of reactor and compounded TPOs II. Proceedings of the Fourth International Coatings for Plastics Symposium, Troy, MI, 2001.
64. J Lawniczak, R Clemens, G Batts, K Middleton, C Sass. How do chlorinated polyolefins promote adhesion of coatings to polypropylene? Conference Proceedings of Advanced Coatings Technology, Detroit, 1993, pp 205–217.
65. J Lawniczak, C Sass, R Evans. Effects of formulation variables on the performance of CPO-based adhesion promoters on polypropylene substrates. Conference Proceedings of Advanced Coatings Technology, Detroit, 1994, pp 305–315.
66. JE Lawniczak, PJ Greene, R Evans, C Sass. Water-reducible adhesion promoters for coatings on polypropylene-based substrates. *J Coatings Technology* 65(827): 21–26, 1993.
67. M Jackson, F Stubbs, J Mecozzi, D Miklos. Chlorine-free, zero VOC, thermoset, waterborne adhesion promoter for thermoplastic polyolefins (TPOs). Conference Proceedings of Advanced Coatings Technology, Detroit, 1997, pp 95–105.
68. TJ Prater, SL Kaberline, JW Holubka, RA Ryntz. Examination of the distribution of a TPO adhesion promoter material in a painted TPO system. *J Coatings Technology* 68(857):83–91, 1996.
69. DJ St. Clair. Coating resins based on melamine cured polyolefin diol. Conference Proceedings, TPOs in Automotive, Novi, MI, 1996.
70. AA Eloursi, DP Garner. Electrostatic painting of plastics I: Electrical properties of plastics and primers. *J Coatings Technology* 63(803):33–37, 1991.
71. AA Eloursi, DP Garner. Electrostatic painting of plastics II: Electric field effects. *J Coatings Technology* 64(805):39–44, 1992.
72. A Calahorra, D Aharoni, H Dodiuk. Carbon filled paints of improved electrical conductivity. *J Coatings Technology* 64(814):33–37, 1992.

73. KS Katti, MW Urban. Effect of carbon black on adhesion to plastics in solvent-borne 2K polyurethanes. *J Coatings Technology* 72(903):63–70, 2000.
74. LP Haack, JW Holubka. Bake oven induced variation of surface chemistry on electrocoat paint: Effect on primer-electrocoat intercoat adhesion. *J Coatings Technology* 72(903):35–44, 2000.
75. FY Hunt, MA Galler, JW Martin. Microstructure of weathered paint and its relation to gloss loss: Computer simulation and modeling. *J Coatings Technology* 70(880):45–54, 1998.
76. S Grace, J Petzoldt. Coating automotive plastics with 2K waterborne polyurethane coatings. Conference Proceedings of Advanced Coatings Technology, Detroit, MI, 1997, pp 72–78.
77. C Hegedus, D Lawson, D Lindenmuth. Two component, waterborne polyurethane coatings: chemistry and application. Proceedings of Twenty-fifth International Waterborne, High-Solid, and Powder Coatings Symposium, New Orleans, 1998, pp 391–408.
78. RL Gray, RE Lee. UV stabilization of polypropylene and TPOs in automotive applications. Conference Proceedings, TPOs in Automotive, Novi, MI, 1996.
79. JE Picket. Photostabilization of plastics by additives and coatings. In: RA Ryntz, ed. *Plastics and Coatings: Durability, Stabilization, Testing*. Cincinnati: Hanser Gardner, 2001, pp 73–86.
80. A Valet. *Light Stabilizers for Paints*. Hannover, Germany: Vincentz Verlag, 1997, pp 46–72.
81. DR Bauer. Stabilization of coatings. In: RA Ryntz, ed. *Plastics and Coatings: Durability, Stabilization, Testing*. Cincinnati: Hanser Gardner, 2001, pp 107–113.
82. G Haake, E Longordo, J Brinen, F Andrews, B Campbell. Chemisorption and physical adsorption of light stabilizers on pigment and ultrafine particles in coatings. *J Coatings Technology* 71(888):87–94, 1999.
83. RD Tokash. Ultraviolet light absorbers: A study of migration susceptibility from flexible topcoats into TPO substrates. Conference Proceedings of Advanced Coatings Technology, Detroit, MI, 1993, pp 173–183.
84. G Haacke, FF Andrews, BH Campbell. Migration of light stabilizers in acrylic/melamine clearcoats. *J Coatings Technology* 68(855):57–62, 1996.
85. N Cliff. Reactable light stabilizers for use over plastic substrates. Proceedings of the Fourth International Coatings for Plastics Symposium, Troy, MI, 2001.
86. N Albrecht. Proceedings of the International Coatings Technology Conference, Chicago, 1996.
87. PE Ferrell, JJ Gummeson, LW Hill, LJ Truesdell-Snyder. The reaction of amines with melamine formaldehyde crosslinkers in thermoset coatings. *J Coatings Technology* 67(851):63–69, 1995.
88. S Haseebuddin, KVS Raju, M Yaseen. Crosslink density and cure window of oligourethane diol/melamine high-solids coatings. *J Coatings Technology* 70(879):35–42, 1998.
89. PJ Schmitz, JW Holubka, L Xu. Mechanism for environmental etch of acrylic melamine-based clearcoats: Identification of degradation products. *J Coatings Technology* 72(904):39–45, 2000.
90. P Lamers, K Johnson, W Tyger. Ultraviolet irradiation of melamine containing

- clearcoats for improved acid etch performance. Conference Proceedings of Advanced Coatings Technology, Detroit, MI, 1993, pp 125–152.
91. M Green. Low VOC carbamate functional coatings compositions for automotive topcoats. Proceedings of Twenty-Seventh International Waterborne, High-Solid, and Powder Coatings Symposium, New Orleans, 2000, pp 224–239.
  92. ML Green. Low VOC carbamate functional coatings compositions for automotive topcoats. *J Coatings Technology* 73(918):55–62, 2001.
  93. PV Yaneff, K Adamsons, RA Ryntz, D Britz. Structure property relationships in flexible silane automotive coatings. *J Coatings Technology*, 74(933): 135–141, 2002.
  94. MJ Chen, FD Osterholtz, EP Pohl, PE Ramdatt, A Chaves, V Bennett. Silanes in high-solids and waterborne coatings. *J Coatings Technology* 69(870):43–51, 1997.
  95. Z He, WJ Blank. Crosslinking with malonate blocked isocyanates and with melamine resins. *J Coatings Technology* 71(889):85–90, 1999.
  96. LW Hill, S Lee. Effect of melamine-formaldehyde structure on cure response of thermoset coatings. *J Coatings Technology* 71(897):127–133, 1999.
  97. R Lomolder, F Plogmann, P Speier. Selectivity of isophorone diisocyanate in the urethane reaction. Influence of temperature, catalysis and reaction partners. *J Coatings Technology* 69(868):51–57, 1997.
  98. T Potter. Chemistry and technology of polyurethane coatings. Proceedings of the 1996 FSCT International Coatings Technology Conference: Polymer Chemistry for the Coatings Formulator, Chicago, 1996.

# 6

## Painting Problems

**Clifford K. Schoff**

Schoff Associates, Allison Park, Pennsylvania, U.S.A.

### 1 INTRODUCTION

Most readers of this chapter will know that painting any surface well is not an easy task and that painting plastics is even more difficult. One reason for the occurrence of problems is that there are so many different plastics. Some are hard, others are soft; many have surfaces of low polarity, others have highly polar surfaces; some dissolve or craze on contact with solvents, others are completely insensitive to solvents. Compared to pretreated metals, plastics generally have lower surface energies; are smoother and less porous (and if they are porous, that causes problems); and are less polar. Plastics tend to be more difficult to wet and adhere to than pretreated metals, particularly where mold release agents or components that migrate to the surface are involved. Coated plastic parts often are required to match other parts on an assembly or vehicle for color and texture. Customers have become more demanding so that appearance that was acceptable a few years ago is considered to be a problem now. There is no question that plastics can be painted and painted very well, but it is important to be aware of the difficulties that can occur and to know what to do about them. This chapter provides information on a number of surface defects and other problems encountered when painting plastics. More information on coatings defects in general is given in Refs. 1–5.

The appearance and durability of a coated plastic are dependent on the entire painting process as well as the properties of the paint and plastic. Before discussing the individual defects and problems, a brief discussion of the various steps in painting plastics is in order.

## 2 PAINTING PROCESS

### 2.1 Cleaning

It is important for any surface to be clean before it is painted. Dirt hurts appearance and affects paintability. Dirty surfaces are difficult to wet and may give adhesion problems or surface defects even if initial wetting seems adequate. Dirt leads to rework and recycling. Most plant cleaning processes work well, but their effectiveness is not always monitored adequately. It is important to audit the cleaning process periodically to determine whether the parts really are clean. I have followed parts through a line and noted that much of the sanding dust that was on the surface before a power wash was still there afterward. It may be necessary to wipe parts with tack cloths before they are washed. If so, then the lighting and operator positioning must be such that the dirt can be readily seen and removed. Even if parts are clean, they may be soiled by racks that are dirty, especially where the dirt on the racks is loose. Racks must be kept clean as well. In fact, the entire line must be kept clean so that clean parts do not become soiled in tunnels, booths, and ovens.

Many plastic parts have mold release agents on their surfaces and plasticizers and other components or additives may come to the surface over time. These surface contaminants must be removed. Sometimes parts are cleaned then stored, which usually means that they need to be cleaned again before they are painted. This is done to remove dirt picked up in storage and any material that migrated to the surface. The cleaning process can cause difficulties. Detergent residues can result in water spotting and other appearance problems. Good rinsing is very important, otherwise one kind of dirt is traded for another.

### 2.2 Application

Plastics can be painted using a number of application techniques, including conventional air spray, airless, electrostatic spray (gun or bell), flow coat, or even dip coating. Conventional spray probably is the most common method. Some lines use both guns and bells. Under the right conditions, the results of paint application can be a smooth coating with no defects. Unfortunately, there are a lot of things that can go wrong. Application can affect appearance in a number of ways ranging from color to smoothness to aluminum flake orientation in metallics. Often these problems are blamed on the paint, but many of them can be solved by adjusting atomization pressures and flow rates and optimizing the ratio between the two.

Application equipment can produce spits, drops, and overspray, all of which can give defects that look much like dirt. Worn or damaged guns and bells are particularly bad for causing bubbles and spits. I have seen worn and nicked bells in a number of facilities where plastics were being painted. Applica-



tion equipment must be kept clean and examined often for wear and damage. Worn or damaged parts must be replaced. Although expensive, it is very useful to have two sets of equipment, one for operation, the other for cleaning and preventive maintenance.

### 2.3 Flash and Cure

In order to achieve necessary properties, coatings must lose their solvents and be crosslinked (cured). The beginning of the flash period is one of great vulnerability for wet coatings. The viscosity is low, contaminants can cause craters, dirt is easy to pick up, etc. The coating becomes more resistant as the flash period continues, then experiences a new period of vulnerability as the coated part enters the oven. The viscosity drops sharply and new contaminants may be encountered.

Cure can be accomplished in a variety of ways. With most paints, cross-linking reactions occur on baking and/or there are two parts that react on mixing. Some paints for plastics are cured by UV radiation. Poorly controlled curing can cause defects, hurt appearance, and severely compromise end-use properties such as scratch and impact resistance. Overcure or undercure can be due to the paint formulation, but that is almost always detected in the lab and the formula is modified until the problem is solved. Mistakes in the manufacture of the paint also can lead to cure problems as can oven temperatures that are too high or too low. Additives in the plastic such as amines may interfere with cure. Degree of cure can be determined in the laboratory by the relatively crude solvent rub technique or analysis of solvent extractables. Thermal analysis (6–9) and dielectric analysis methods (10–13) can be used to follow the cure process or determine the degree of cure. Options for testing cure on line (or immediately off line) are very limited and I am under the impression that it is rarely measured. If parts seem soft or tacky, more testing may be done. Painted auto parts occasionally are soaked in fuel to evaluate resistance that is a function of cure.

## 3 SURFACE DEFECTS

A number of defects can occur on the surface of the coating during or soon after application and/or during cure. These defects are unacceptable because they spoil the appearance of the part or object and may contribute to durability problems. Because of them, many parts must be discarded, recycled, or sanded and repainted. If at all possible, these defects must be prevented, but before we prevent them we must understand why they occur.

### 3.1 Surface Tension–Driven Defects

A number of surface defects are caused by or affected by surface tension. However, surface tension is not only a troublemaker. It is the driving force for level-

ing and, therefore, is responsible for smooth coatings with good appearance as well as for defects. Several different defects are discussed in the following text. The reader should refer to Refs. 1–5 and 14–17 for additional details on surface flows and surface tension–related defects.

### 3.1.1 Craters

Other than dirt, craters probably are the most common type of surface defect. They also are the most frustrating and irritating defect to deal with as well as being the most difficult problem to solve. Craters are small bowl-shaped depressions that appear in a coating. They occur where there is a low surface-tension contaminant in the paint, that falls on it, or is on the substrate. The paint flows or is pushed away from the low surface-tension area, leaving a circular defect as shown in Figure 1. Many, but not all craters have raised rims as shown in the figure. Craters form very rapidly, usually during or immediately after application of the paint. With baked coatings, they also can occur in the oven.

One of the difficulties with craters is that there are so many possible causes. These include hydrocarbon and fluorocarbon oils and lubricants, silicones, plasticizers, resin gel particles, oven condensate, dirt, fibers, filter mate-

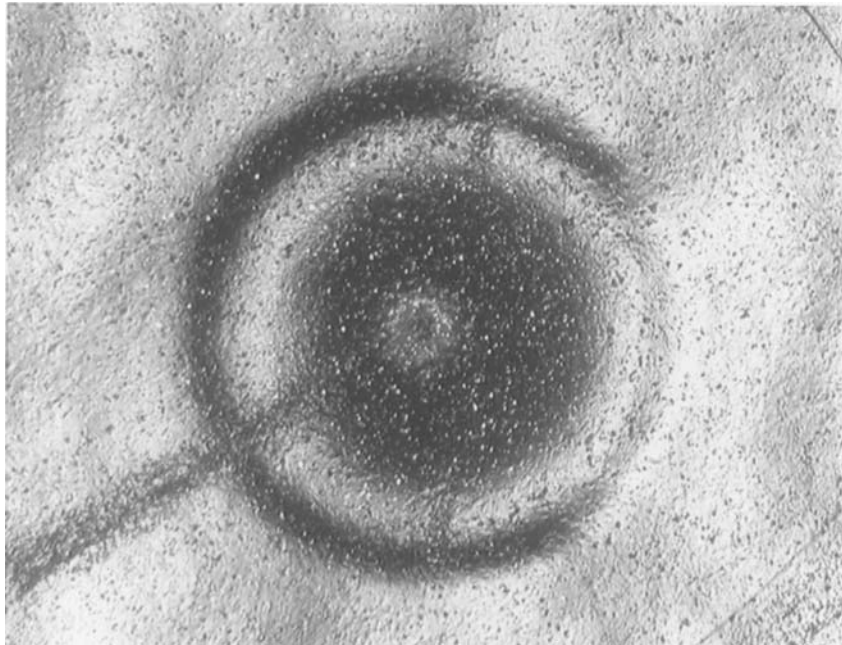

FIG. 1 An example of a crater in a metallic topcoat.

rial, overspray, antiperspirants and other personal care products, poorly dissolved or dispersed additives (especially silicones), contaminated raw materials, and contaminated drums, totes, or other containers. To make matters worse, when the defect is examined after the coating is cured, analysis rarely identifies the material that caused the crater. Whatever it was, it evaporated in the oven or dissolved back into the paint. Even very powerful analytical instruments usually see nothing but paint in the crater. The combination of many possible causes and the difficulty of identifying the contaminant means that root cause analysis of craters is very difficult and often fails. Many crater problems go away without the cause having been determined. However, careful detective work when craters do occur, coupled with good housekeeping and flow control all the time, usually can keep craters at a low level.

### 3.1.2 Dewetting (Crawling)

This defect involves the pulling away of a paint film from an edge, hole, or low surface-tension contaminant or surface. An example of dewetting is shown in Figure 2. Pulling away from a low surface-tension region is similar to crater formation, but dewetting from edges needs more explanation. Surface tension

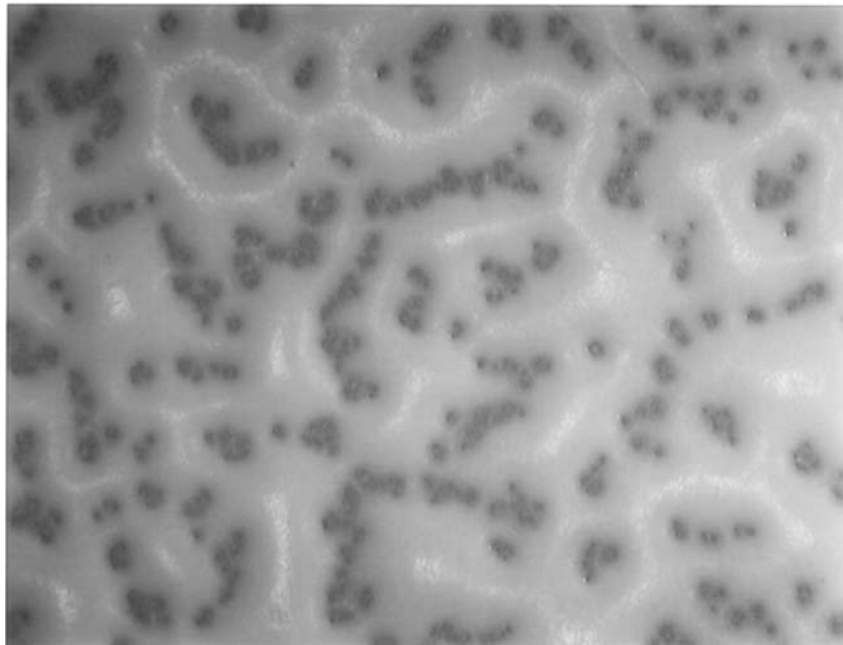

FIG. 2 Dewetting of a topcoat over an undercoat.

always tries to minimize surface area. At edges, this manifests itself as flow to make a smooth cross-sectional curve and a thin coating at the edge as shown in Figure 3. Additional flow away from edges occurs on baking if the edge heats up faster, which causes the surface tension to drop in that area and gives a surface-tension gradient. Another aspect is that once flow begins, it may continue well beyond where it is expected to stop. For example, you can force wet a low surface-tension Teflon or polypropylene sheet by spraying it with paint. This usually will produce a continuous film, but if this wet film is stressed by running a stick along it, many paints will roll back a considerable distance, far beyond the original groove.

### 3.1.3 Telegraphing

This defect involves the reproduction of surface features on a substrate by a coating applied to that substrate. Instead of hiding surface irregularities such as a rough surface, sand scratches, fingerprints, solvent wipe marks, detergent residues, etc., the coating makes them more obvious. Figure 4 shows telegraphing of a fingerprint. Telegraphing in light metallic basecoats can give dark or light streaks over sanded areas (often called sand mars) or wipe marks on primers. Telegraphing is not completely understood, but it involves surface tension-driven flow and the driving force appears to come from low surface-tension residues or from sharp edges or both. Wetting and flow on completely sanded

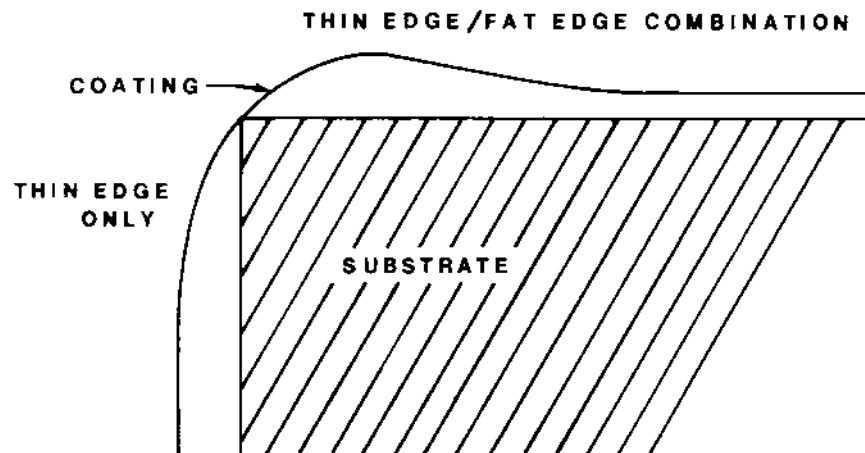
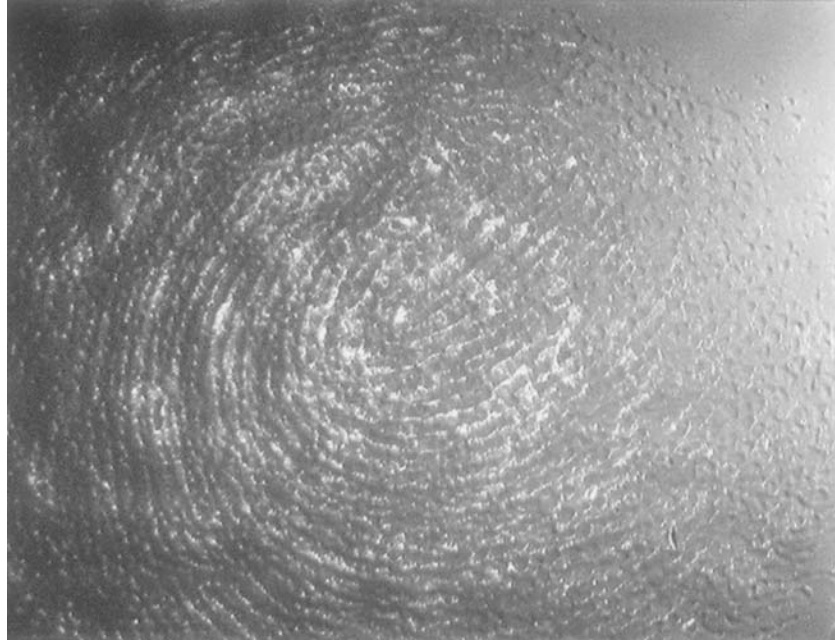

FIG. 3 Diagram showing a thin edge and poor edge coverage along the vertical and a fat edge or picture framing on the horizontal. (From Ref. 4, used with permission.)



**FIG. 4** Telegraphing of a fingerprint. Instead of hiding the fingerprint, the paint has made it much more obvious.

areas are affected by the roughness, porosity, and increased wettability of the abraded surface.

Fiber read-through in sheet molding compound (SMC) and other fiber-filled composites can be considered as a special case of telegraphing. The glass fibers in the composite are amplified instead of being hidden. This may be due to the fibers being too close to the surface, but usually occurs when solvents in the paints penetrate the composite and swell the surface area producing an effect similar to grain raising in wood. Factors that affect fiber read-through include the quality of the substrate, the solvents used in the paints, effectiveness of the primer in acting as a barrier, and the bake temperatures used for the primer and the paints applied over it.

#### 3.1.4 Bondline Readout

This defect appears over plastic parts with reinforcements (18). The bonded backing acts as a heat sink and the heat-up and cool-down behavior of backed and unbacked areas are different. This results in a temperature difference between reinforced and nonreinforced areas that may be as large as 30°C (50°F)

during the bake, although it usually is much smaller. Even a small difference may produce a significant temperature gradient if it occurs over a short distance. This defect can occur even before the oven, probably due to different degrees of cooling by solvent evaporation during the flash. Temperature gradients cause surface-tension gradients (higher temperature means lower surface tension) that in turn cause flow. Noticeable steps or ridges in surfaces of clears and color differences in pigmented coatings may occur because of this flow. The effect can be very striking on large parts such as automobile hoods and decklids where every rib of the underlying reinforcement can be seen on the surface. Color effects may be due to differences in film thickness in adjacent areas or, in coatings containing aluminum flakes, due to flake orientation differences. For example, light metallics give a dark smudge along the bondline when bondline readout occurs.

Bondline effects have been seen immediately on application (when any evaporative cooling was just beginning). It is not known whether this was due to different temperatures across the part (e.g., from the primer bake) or because of electrostatic effects. Bondline readout is greatly affected by the application process (type of gun or bell, number of passes), flash time (longer flash reduces the effect), the thickness of the primer, the design of the part, and the temperature of the oven. Bondline effects that occur on application have been known to diminish or disappear with higher bake temperatures.

### 3.1.5 Picture Framing (Fat Edge)

This defect consists of a bead or thick border along or near the edge of a part as shown in Figure 5 and diagrammed in the upper part of Figure 3. This defect is less common on painted plastic than on metal, probably because plastic parts tend to have more curvature and fewer sharp edges than do metal parts. Fat edge can be due to electrostatic spray wrap over conductive primers as well as to surface-tension effects on application or in the oven. It is possible that once a bead begins to build, convection flow (see the following text) will cause it to grow even larger. The bead may be right at the edge or a short distance back from it. Evaporative cooling at the edge on application can cause flow toward the edge. If the edge heats up more rapidly than the bulk of the part, there will be a low surface-tension region along the edge and paint will flow away from the edge. However, as the solvent in that hotter area is driven off, the surface tension at the edge will increase and flow will go toward the edge again. Even if the bead is not obvious, the extra thickness may lead to popping.

### 3.1.6 Convection Flow Defects

It is difficult to know where to place these complex defects that include Bénard cells, flooding and floating, and probably many unexpected roughness and texture effects. They are caused by convection cells with flow beginning near the

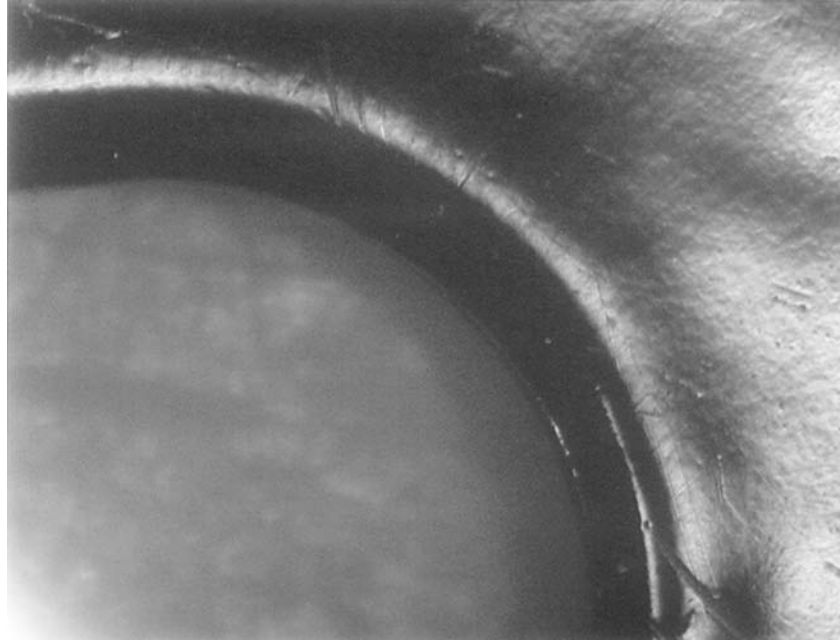

**FIG. 5** Picture framing or fat edge along the edge of a slot in a part.

coating-substrate interface, rising up to the surface, then dropping back down as shown in Figure 6. This flow is driven by surface tension, but also is affected by density effects. The defects are made worse by low viscosity, rapid solvent evaporation, and pigment flocculation. They are very noticeable when they occur in a coating with a mix of colored pigments (especially where aluminum pigments are involved—see Figure 7). They also occur in whites where they can lower gloss and in clears where they affect smoothness. Convection cells in a topcoat can cause a scouring action on the coating underneath and this probably is responsible for some of the interactions between bases and clears that hurt appearance.

### **3.2 Wetting and Wettability**

This is a good place to stop and discuss the process by which a liquid interacts with a solid. This process is called wetting. From the standpoint of painting, it involves bringing the liquid paint into contact with the substrate, displacing air and moisture, and adsorbing the paint onto the surface. Wettability is the ability of a substrate to be wet by a particular liquid. Wettability usually is described in terms of a sessile or resting drop (see Fig. 8). The contact angle ( $\theta$ ) between

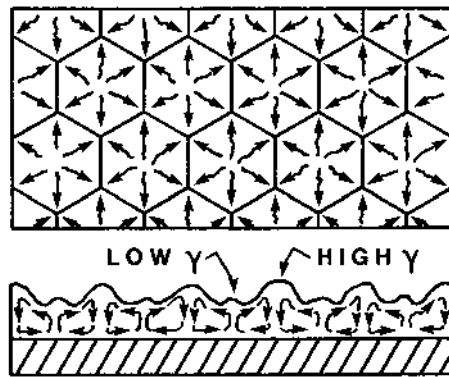

FIG. 6 Diagram of convection flow. (From Ref. 4, used with permission.)

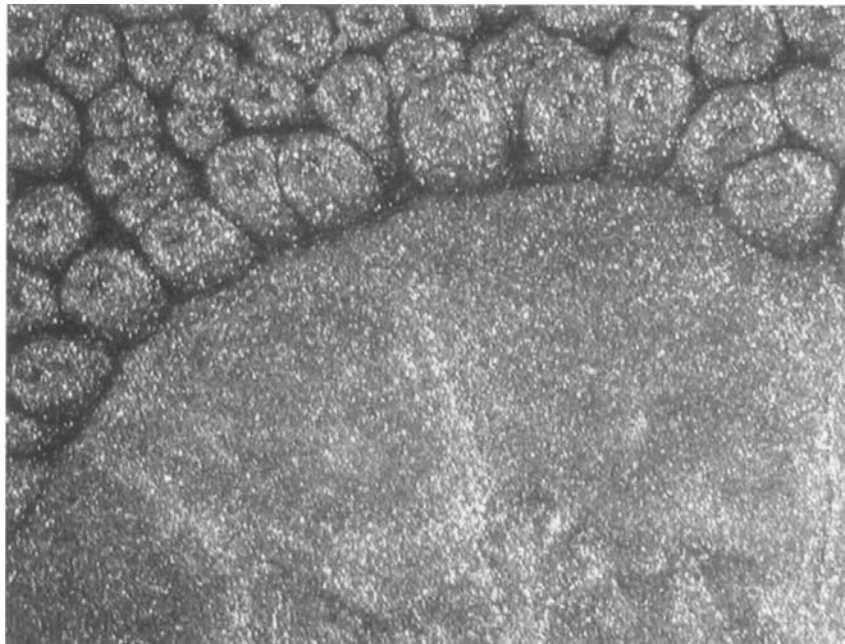

FIG. 7 Blue metallic elastomeric coating: upper part—Bénard cells formed by convection cells; lower part—flooding and floating of aluminum flake pigment.



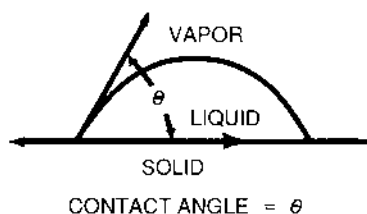

FIG. 8 Diagram of a sessile (resting) drop on a substrate. The angle  $\theta$  is called the contact angle and is a measure of the wettability (ease of wetting) of the substrate. (From Ref. 5, used with permission.)

the drop and the surface is a measure of wettability. A drop that spreads and forms a low contact angle with the substrate is said to wet well. We also say that the surface is highly wettable by that liquid. There is an intermediate situation where the drop gives a low-to-moderate contact angle ( $20\text{--}50^\circ$ ). We tend to call that wetting also, but it definitely is different. This intermediate state is quite common with paints and typical substrates, including many plastics.

Wettability is determined by who wins the competition between paint-substrate adhesive forces and cohesive forces in the paint (19). Adhesive forces cause the paint to spread. Cohesive forces cause the drop to bead up. The contact angle is determined by the balance between the two forces. Wetting occurs when the liquid paint “likes” the substrate, that is, is compatible with it, and beading occurs when the paint does not “like” the substrate. Surface contamination, sanding, cleaning, and other processes can change this compatibility, thereby changing the wettability.

### 3.3 Volatile-Related Defects

Surface tension-driven defects certainly are not the only ones that occur on paint lines. Paints contain volatile solvents that evaporate during the flash and bake. Other gases such as air may be incorporated into the paint during stirring, pumping, or spraying. In addition, volatile materials may come from cure reactions or the plastic substrate. Volatiles can be trapped as a coating dries and cures resulting in pinholes, bubbles, or crater-like blowouts. Solvent pops (Fig. 9) occur when solvent is trapped as the film forms and blows out rather than diffusing through the film.

The production of volatiles from a substrate often is called gassing, but with SMC plastics, it is termed porosity blowout. The defect usually looks like a crater or solvent pop, but careful examination with a microscope often shows a small hole that goes down into the substrate (Fig. 10) A cross section looks like the diagram in Figure 11. The culprit usually is water vapor trapped in

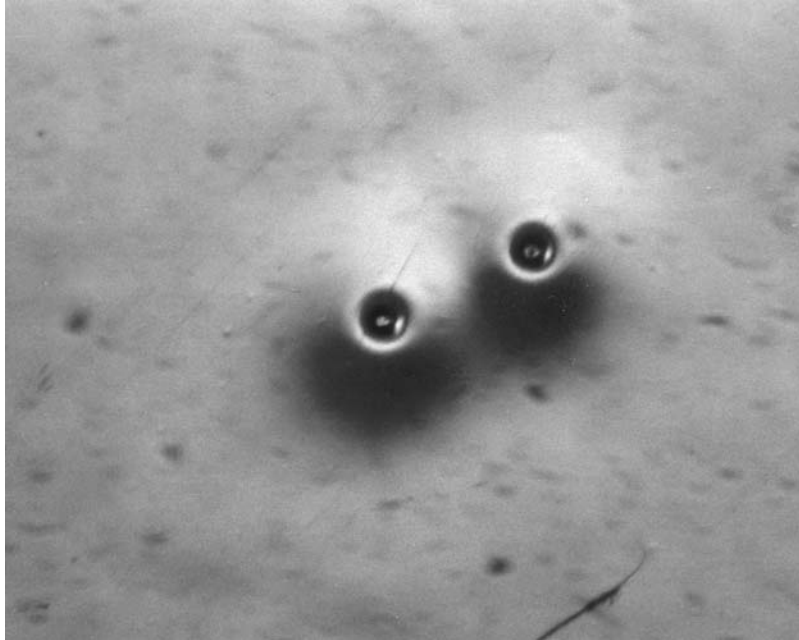

FIG. 9 Solvent popping. (From Ref. 5, used with permission.)

pores in the plastic, although other gases may be involved. To reduce or prevent this defect, it is necessary to use a primer that seals the SMC surface well. Gassing or blowout is possible over other plastics as well. Any product that has bubbles and pores, especially close to the surface, has a potential for this defect. Another volatile-related defect, air entrapment, is a problem for many coatings. Agitation during manufacture, handling, or application may cause air to mix in or dissolve in the paint. On application, the air tries to leave the film, but often is trapped or the bubbles break late in the film formation process so that holes are left that do not flow out. The result often is difficult to distinguish from solvent pops or gassing.

A defect that I have seen a number of times on painted plastics is what I call micropopping (Fig. 12). Very small (0.4–2 mils or 10–50  $\mu\text{m}$  in diameter) bubbles, bumps, or pinholes appear in the film, often late in the bake. To the eye, the result may look like haze, give fuzzy reflections or just an appearance that does not look right. The cause may be trapped solvent, volatile by-products of the curing process, or even clumps of flow-control agent or pigment. Micropopping coupled with bumpiness that often occurs on shrinkage during cure can turn a smooth glossy surface (when wet or early in the bake) into a rough ugly one.



FIG. 10 Gassing from a plastic substrate. Note the hole in the center of the defect.

### 3.4 Flow-Related Defects

A number of the defects described previously involve flow driven by surface tension, but there also are flow defects where surface tension has little or no involvement. When a paint is applied, it is expected to flow out and level to produce a smooth film. Unfortunately, this does not always happen. Sometimes the viscosity is so high when the paint arrives on the part or increases so quickly after application that there is little flow and the result is a rough, bumpy surface

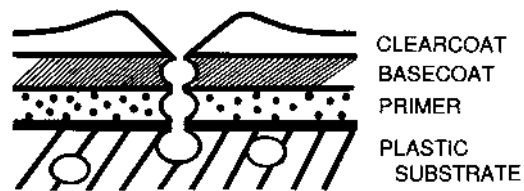

FIG. 11 Diagram of the cross section of a gassing defect. (From Ref. 5, used with permission.)



**Fig. 12** Example of micropopping. Perhaps, microbumps is a more accurate description in this case. To the eye, the effect is one of fuzziness of reflections.

like the peel of an orange (Fig.13). In base/clear systems, the clear usually is blamed for orange peel, but a basecoat with poor flow can cause this as well. This usually is due to telegraphing of the basecoat topography so that the clear really is bumpy, but I have seen cases in which there was an optical illusion where clear was smooth, but the rough basecoat showed through. If the paint viscosity is too low after application or too much is applied, the paint may flow too well on vertical surfaces (particularly at holes or style lines), causing ugly sags, runs, and slumps. Even if thicker areas are not considered objectionable to the eye, popping may occur in them.

### **3.5 Other Defects**

#### **3.5.1 Dirt**

The most common defect of all is dirt. This defect rarely is a concern to formulators, yet is a serious problem in most plants where their paints are applied. Most dirt comes from the paint user's facility. Occasionally, the dirt is in the paint as it arrives in the plant and sometimes pigment flocs or seeds form during

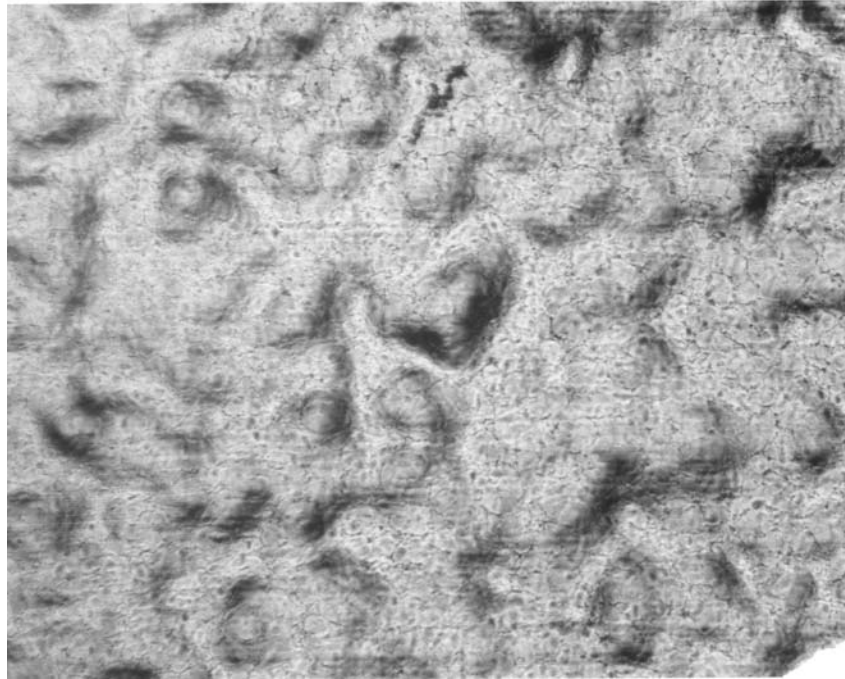

FIG. 13 Orange peel as seen through the microscope.

the circulation of the paint, but both of these are rare compared to dirt from the plant and the people who work in it.

There are many different kinds of dirt such as fibers (Fig. 14), sanding dust, resin gel particles, dried paint particles and chips, oven dirt (Fig. 15), rust, etc. Dirt sources include clothing; wiping cloths; tack rags; gloves; faulty or clogged filter bags that break; overhead chains and carriers; racks and hangers; ovens; compressed air for application; food (eating in the booth); dried paint in pipes and hoses; roof leaks; rust and flaking paint in booths and tunnels; hoses that are disintegrating, etc. Road and construction dust, truck and locomotive exhaust, pollen, insects, fly ash, soot, and other particulates may enter from outside the plant. Sometimes plant exhaust and inlet pipes are positioned so that plant exhaust is pulled back into the paint shop or paint area when the wind blows in a certain direction. Poor work practices such as playing around on the paint line, the wearing of nonapproved gloves and clothing, sprayers not wearing gloves, use of booths as passageways, and careless tacking and wiping all can cause dirt or make it worse. Some defects that look like dirt really are due to application problems. Examples are spits, drops, and overspray. Worn, dam-



FIG. 14 Dirt—an example of a fiber.

aged, or dirty application equipment; too much shaping or fan air; excessive paint flow rates; excessive voltage; and loose or overtightened caps and nozzles all can cause “dirt.”

### 3.5.2 Color Problems

Color is a surface attribute, but a coating being the wrong shade is not a surface defect in the usual sense. Color matching of coated parts made of different plastics or of metal and plastic can be very difficult. In an auto plant, the plastic always is expected to match the painted steel, but I have been on lines where it turned out that the original equipment manufacturer (OEM) coating was the wrong color, not the one on the plastic parts. Color can be affected by film thickness, by the method of application, whether there is pigment flocculation or not, etc. A batch of paint may be the correct color to begin with, but on circulation, the pigment may slowly flocculate causing the color to drift. A similar thing can happen with aluminum flake in a metallic paint. The parts become darker with paint circulation time as the flake clumps together and no longer reflects light. Sometimes an off color is caused by a colored impurity, usually yellow or pink. This may be in the paint or reducing solvent or may

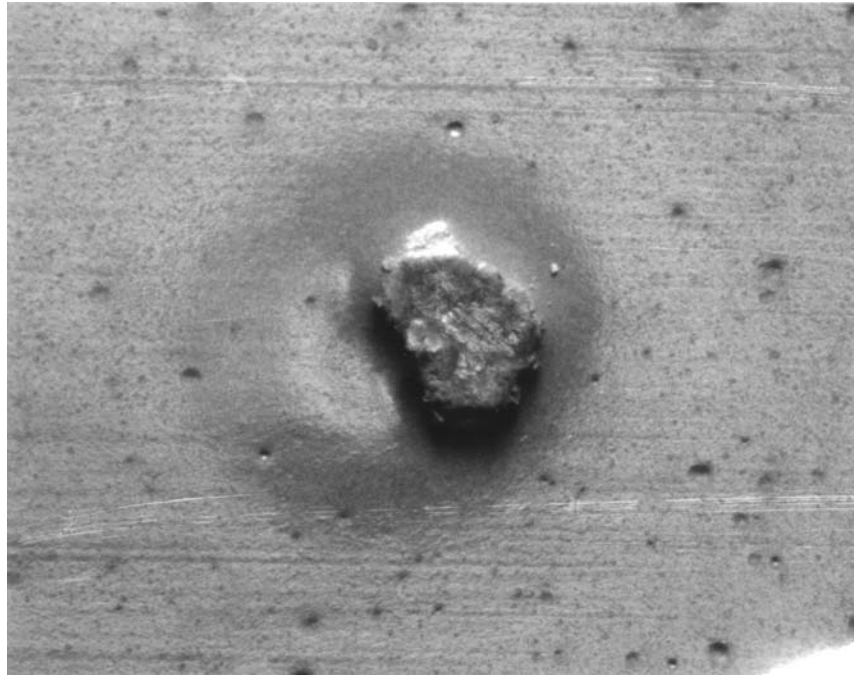

FIG. 15 An example of oven dirt.

migrate up from the plastic or another coating layer. Amines and various additives, including UV absorbers, have been blamed for such problems.

#### 4 FIELD PROBLEMS/FAILURES

Field failures may seem to be completely different from painting problems, but they may be connected to a greater extent than we realize. An excellent source of information in this area is Ref. 20. The author points out that for a coating to fail, it must be stressed. How it responds to this stress depends on the physical and mechanical properties of the coating and its interface with the substrate. These, in turn, depend on the chemistry of the coating and the degree of cure, but may also be affected by the application process, defects in the coating, or repairs to defects. Let us consider some field failures.

##### 4.1 Adhesion

The most serious problem in paint for plastics is loss of adhesion to the plastic. Paint is useless if it does not stick. Adhesion failure may occur soon after appli-

cation or may occur later in the field. The failure may involve very small areas or very large ones. A high stress such as scraping may be necessary or the paint may sheet off seemingly with little or no force. As far as a paint user is concerned, a failure is a failure regardless of the magnitude, timing, or force that is needed. However, these differences are very significant to someone who solves problems. For example, failure after some period of time or failure with little stress may mean that a plastic component or additive has migrated to the plastic-coating interface giving an intermediate layer. This weak boundary layer will interfere with the plastic-coating bond, yet will have little or no cohesive strength of its own, so adhesion failure occurs.

What does it take to achieve good adhesion? The first requirement is intimate contact between two surfaces. This is where wetting comes in. However, wetting is a necessary, but not sufficient condition for good adhesion of a dried or baked coating. In fact, there are paints that wet surfaces very well, but are designed to be temporary and that can be peeled off easily once they are baked and cured. Wetting does involve adhesion of the liquid paint to the substrate, but loss of solvent and other changes may destroy this bonding. The second requirement is that one material must adsorb on the other. In order to do this, they must be highly compatible with each other. There is an old adage that “like dissolves like.” We also can say that “like wets like” and “like adheres to like.” The third requirement is that there be polar groups on both materials to aid in the formation of adhesive bonds. There is evidence in the literature (21–23) that matching the polarities of the cured paint and the substrate contributes to good adhesion. This explains why polar coatings do not stick very well to nonpolar or low polarity plastics. Adhesion promoters are based on the concept of linking unlike materials by having a two-faced layer that shows one face to the nonpolar plastic and a very different face to the polar paint. This works even better if the promoter solvents swell the plastic and allow penetration by the polymer chains in the promoter.

Adhesion failures over plastics sometimes only occur in certain places on parts, such as on the corners of bumpers or in the area of the mold gate. Analysis has shown that these areas have different compositions or different degrees of crystallinity from the rest of the surface of the part. This can be due to temperature differences in the mold, imperfect mixing, or different stresses and strains during filling and cure.

One possible cause of adhesion loss is degradation of the surface of one of the intermediate layers (primer, adhesion promoter) or the plastic by ultraviolet light. It only takes a small amount of degradation at an interface to hurt adhesion. The topcoats are supposed to protect the layers below, but thin clear- or basecoat films, low pigment loadings, and loss of UV absorbers can allow UV transmission. Pigments provide UV protection by blocking out the light and



many also absorb UV. Additives are used to absorb UV light and change the energy to heat energy or act as free radical scavengers.

#### 4.2 Mar and Scratch

The terms *mar* and *scratch* refer to surface damage due to contact with sharp or rough objects. There is general agreement that a *scratch* is a mark or injury produced on a surface by something that is sharp or has a ragged edge. It often involves fracture of the surface. Unfortunately, the term *mar* is not well defined and means different things to different people. It may be used to refer to any surface damage or only to certain kinds such as abraded or off-color spots or areas. Damage can occur in many places. Painted parts are exposed to a number of possible scratch and abrasion situations even before they become part of a car, piece of equipment, or other object. Handling, packaging, storage, and shipping all are operations that can result in damage. This is compounded by the fact that many coatings take time to develop resistance and may be easily scratched immediately after painting. During use there are many additional dangers for the surface. Fortunately, unless they are undercured, coatings for plastics tend to be tough and flexible and most have reasonably good scratch resistance after their initial tenderness. The surface often deforms instead of fracturing and the resultant indentation or groove can heal, especially in warm weather.

#### 4.3 Friction-Induced Damage (Gouging)—Bump and Rub Impacts

A type of defect that occurs on painted thermoplastic olefin (TPO), particularly on auto bumpers is damage that occurs when the bumper rubs against a post, wall, or other immovable object. A strip of coating shears off along with the top layer of the TPO. Resistance to such damage does not seem to be related to the adhesion between the coating and the substrate, but rather to the cohesion between the surface layer and bulk of the TPO.

#### 4.4 Stone Chipping

Cars and trucks are continually bombarded by stones thrown up by their own tires and those of vehicles in front of them or passing them. Many parts of North America have gravel roads and/or gravel shoulders on paved roads. Even paved roads can have loose material. Some vehicle designs (sloping hoods, tires that stick out beyond fenders, lack of mudguards or protective coverings at the back of fender cutouts, etc.) invite damage. Considering all of this, stone chipping is a surprisingly minor problem and coated plastics suffer far less than coated metal. Resistance to stone chipping depends on having a combination of excellent adhe-

sion of all layers, good mechanical properties, and the ability to absorb much of the energy of the stone as it strikes the surface. Plastics tend to give with the impact, whereas metals do not. Damage is possible, but warranty claims and customer complaints are rare, so there is less concern than with other defects.

## 5 TOOLS

A worker needs tools and so does a coatings problem solver. By tools, I mean principles and techniques as well as instruments. Many tools are available and I will discuss a number of them.

### 5.1 General Tools

#### 5.1.1 Light Microscope

This is the most useful single piece of equipment for solving defect problems. It is good to use two of them, a low power (5–100X) stereo microscope for looking at defects and a higher power (100–1000X) one for cross sections, examining wet paint, etc. Microscopes should be connected to still or video cameras for documentation of what is seen. Video cameras can be used to print still pictures (using a videoprinter) or videotape the baking process and the formation of defects. Addition of a capture board and image analysis software enables the investigator to take and store pictures, insert them into documents, send them by email, etc.

#### 5.1.2 Root Cause Analysis Methodology

Root cause analysis involves the determination of the basic or underlying cause of a defect or problem and the providing of evidence that it is the cause. We know that craters are caused by contaminants, but the root cause of a cratering outbreak may be poor tote cleaning, a contaminated drum, overreduction of the paint so that it flows too much, or a batch of paint that is unusually sensitive to contaminants that always are present. It may be clear that a defect is a solvent pop, but the root cause could be an application problem that causes fat edges or sags that, in turn, lead to pops. Root cause analysis often takes a lot of detective work, experimentation, and documentation. Sometimes it takes longer than it did to solve the problem. The point is that if the true root cause has been identified and removed or fixed, the problem or defect should not occur again.

#### 5.1.3 Regular Audits

Audits for dirt, craters, to measure whether improvements have occurred, whether best practices are being followed, condition of application equipment, whether there is oil in the compressed air, etc. are very important for reducing and ultimately preventing painting problems. Such audits should be done on a

regular basis and ratings should be done against standards. Audits can and should be incorporated into ISO 9000 or other quality process methodology. Self-auditing by teams or departments is important and useful, but exchange audits by people from other plants or parts of an organization also should be done.

## 5.2 Tools for Characterizing Wetting and Wettability

### 5.2.1 Wetting Tests

The main technique for investigating wetting problems is the measurement of the contact angle of a specific liquid or liquids on the surface of interest. This normally is an advancing angle, that is, during formation the drop advances across the surface. The receding contact angle where a drop retracts over a previously wetted surface would seem to be more useful for characterizing de-wetting phenomena, but it is rarely measured in the coatings industry.

*Critical Surface Tensions.* Much wettability testing owes its basis to Zisman and his critical surface tension of wetting (24,25). The contact angles of various liquids (often a homologous series of hydrocarbons) on the surface are determined and the contact angles are plotted versus the surface tensions of the liquids (see Fig. 16). The plot is extrapolated to  $\cos \theta = 1$ , that is,  $\theta = 0^\circ$ , which represents the point where the liquid would just spontaneously spread if applied as a drop. This point defines the critical surface tension,  $\gamma_c$ . As long as the

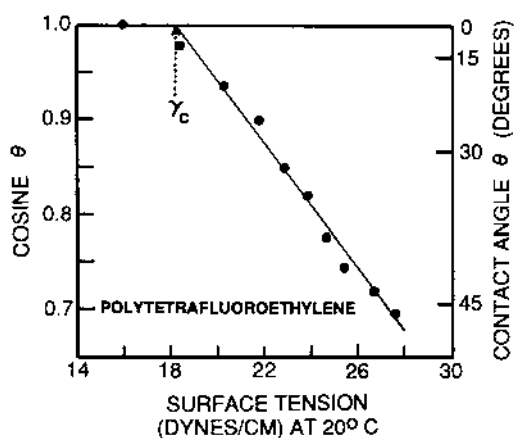

FIG. 16 Critical surface tension (Zisman) plot for wettability of polytetrafluoroethylene by n-alkanes (25). The parameter  $\gamma_c$  is the critical surface tension. (From Ref. 5, used with permission.)

surface tension of the paint is below the critical surface tension of the substrate, the paint will spontaneously wet the surface and spread over it. Zisman plots have long been useful in predicting or explaining wetting problems. Table 1 lists critical surface tensions of a number of different kinds of substrates, including many plastics (4,26,27).

It should be pointed out that a  $0^\circ$  paint contact angle (paint surface tension < critical surface tension) is not an absolute requirement for good performance. The Zisman analysis deals with a drop on a smooth surface, whereas painting involves a film or layer that has been applied forcibly to a relatively

**TABLE 1** Critical Surface Tensions from Zisman Plots

| Substrate                                   | Critical surface tension,<br>$\gamma$ (dynes/cm) |
|---|--|
| Untreated steel                             | 29–30  |
| Fe phosphated steel                         | 43   |
| Zn phosphated steel                         | 45–56  |
| Treated aluminum extrusions                 | 33–35  |
| Tin-plated steel                            | 35   |
| Azdel 817 polypropylene/FG                  | 21   |
| Bayflex 110-25 (unfilled) polyurethane      | 26   |
| Bayflex 110-50 polyurethane                 | 16   |
| Capron nylon 6                              | 31   |
| Cycolac GPM-5600 ABS                        | 27   |
| Cycoloy C-2950 ABS                          | 20   |
| Dow Magnum 344HP ABS                        | 32   |
| Dow Pulse 830 ABS/polycarbonate             | 28   |
| Dow Spectrum 50 polyurethane (unwashed)     | 17   |
| (power washed)                              | 31   |
| (power washed/solvent wiped)                | 33   |
| GTX Nylon-PPO Alloy                         | 32   |
| Lexan FL-900 polycarbonate                  | 32   |
| Lexan LS2 polycarbonate                     | 24   |
| Noryl FN215 PPO                             | 28   |
| SMC styrene-polyester (untreated, unwashed) | 15–25  |
| (power washed, solvent wiped)               | 36–41  |
| TPO Bailey 3183                             | 24   |
| TPO Himont 3041C, 3131, 3183                | 23–24  |
| TPU/Estane                                  | 23   |
| TESLIN                                      | 28   |
| Xenoy 1102U polycarbonate/polyester         | 27   |
| Xenoy 2230 EU                               | 20   |

Source: Refs. 4, 27.

rough surface. Good wetting and adhesion can occur with contact angles considerably above  $0^\circ$ . However, it is a good idea to try to keep the contact angle as low as possible. Most automotive paints have surface tensions of 25–30 dynes/cm, so substrate critical surface tensions should be above 30 dynes/cm, preferably above 35.

Some of the plastics listed in Table 1 have very low critical surface tensions and would be difficult to wet, whereas others have relatively high surface tensions and should be wettable by many paints. The two examples of the effect of cleaning (Dow Spectrum and SMC) show considerable increases in critical surface tension and, therefore, wettability. It should be pointed out that most of these critical surface tensions are like snapshots in time. Unless a range is given, each value is for a given specimen from a given batch of parts or plaques made at a certain time. Different mold conditions, cleaning or the lack of it, and other variables could greatly affect the result (and the wettability).

Contact angles of single liquids sometimes are used to characterize surfaces. For example, Cheever (28) used water contact angles to differentiate between surface regions of polyester-styrene SMC automotive moldings. By making a large number of measurements across the surface, a contact angle map was generated. Cheever was able to estimate the components present on the surface and relate wettability to coating peel strength. Results correlated with mold and temperature effects. Water contact angles also have been used to test surface cleanliness after cleaning operations, ease of wettability by waterborne paints, and the effectiveness of rinsing processes. Another useful single liquid for testing is the paint itself. Comparison of contact angles of different paints or formulations on a substrate of interest can be used for problem solving or optimizing a formulation for wetting.

*Solid Surface Tensions.* Zisman plots are very useful, but, in a number of cases, other techniques seem to explain wettability differences between surfaces better (4,5,26,29,30). Solid surface tension (SST) models that take into account the polarity of surfaces have turned out to be effective. A model that I like is the Owens-Wendt-Kaelble (O-W-K) relationship (31,32), which uses two components (dispersion and polar) such that SST,

$$\gamma_s = \gamma_s^d + \gamma_s^p$$

Contact angles are measured with two liquids (e.g., water and methylene iodide) and values are substituted into the Owens-Wendt-Kaelble equation (4,5,26,31,32)

$$\gamma_l(1 - \cos \theta)/2 = [(\gamma_l^d \gamma_s^d)^{1/2} + (\gamma_l^p \gamma_s^p)^{1/2}]$$

where  $\gamma_l$  is the surface tension of the test liquid and  $\gamma_s$  is the surface tension of the solid in question. An equation is written for each liquid. All the quantities are known except  $\gamma_s^d$  and  $\gamma_s^p$ , the dispersion and polar components of the SST.

We are left with two equations in two unknowns and these can be solved to give the unknown values. The dispersion and polar components are then added together to give the total SST. The polarity also can be expressed as a percent of the total surface tension or as the fraction. Table 2 lists some SSTs along with the dispersion and polar components and also the percent polarity for a number of relatively pure polymers (data from our laboratory). They are listed in decreasing order of total SST. Extensive tables of polymer surface tensions may be found in reference 33. Table 3 (27) lists surface parameters for a number of substrates, mainly plastics.

The first six polymers in Table 2 have moderate-to-high SSTs and would be expected to be wettable. The seventh one, poly(vinyl fluoride), might be borderline for wetting by some paints. That polymer and the next three listed show the effect of increasing degrees of fluorination and the last two should be (and are) almost impossible to wet. The polar components vary within a fairly small range of low-to-moderate values, although the range of percent polarity is wider.

The total SSTs listed in Table 3 range from 29 to 53. The higher values indicate good wetting, but the boundary between wetting and nonwetting will depend on the paint and the application conditions. It will be noted that the total SST values are not the same as the critical surface tensions and, in most cases, are considerably higher. This is not unusual. However, with metals and coatings, dispersion component values often are close to critical surface tensions, but this does not seem to hold for most of the plastics in this table. The polarities of many of the plastic surfaces were higher than I expected. This may reflect the effectiveness of treatment and cleaning rather than basic surface properties.

**TABLE 2** Solid Surface Tensions of Polymers by Owens-Wendt-Kaelble Procedure

| Polymer                     | Total | Dispersion component | Polar component | Polarity (%) |
|-----------------------------|-------|----------------------|-----------------|--------------|
| Nylon 6-6                   | 47    | 41                   | 6               | 13           |
| Poly(ethyleneterephthalate) | 47    | 43                   | 4               | 9            |
| Poly(vinylidene chloride)   | 45    | 42                   | 3               | 7            |
| Poly(vinyl chloride)        | 42    | 40                   | 2               | 5            |
| Polystyrene                 | 42    | 41                   | 1               | 2            |
| Poly(methyl methacrylate)   | 40    | 36                   | 4               | 10           |
| Poly(vinyl fluoride)        | 37    | 31                   | 6               | 16           |
| Poly(vinylidene fluoride)   | 30    | 23                   | 7               | 23           |
| Poly(trifluoroethylene)     | 24    | 20                   | 4               | 17           |
| Poly(tetrafluoroethylene)   | 14    | 12                   | 2               | 14           |

**TABLE 3** Solid Surface Tensions of Plastics and other Coating Substrates by Owens-Wendt-Kaelble Procedure

| Substrate                       | Surface tensions (dynes/cm) |                      |                 |              |
|---------------------------------|-----------------------------|----------------------|-----------------|--------------|
|                                 | Total                       | Dispersion component | Polar component | Polarity (%) |
| Zn phosphated steel             | 42                          | 35                   | 7               | 17           |
| Primer-surfacers                | 35-44                       | 27-41                | 4-7             | 9-20         |
| Azdel 817                       | 48                          | 31                   | 17              | 35           |
| Bayflex 110-25 (unfilled)       | 40                          | 31                   | 9               | 22.5         |
| Bayflex 110-50 Polyurethane     | 32                          | 28                   | 4               | 12.5         |
| Capron nylon 6                  | 47                          | 35                   | 12              | 25.5         |
| Cycolac GPM 5600 ABS            | 45                          | 37                   | 8               | 18           |
| Cycoloy C-2950 ABS              | 51                          | 40                   | 11              | 27.5         |
| Dow Magnum 344HP ABS            | 42                          | 33                   | 9               | 21           |
| Dow Pulse 830 ABS/Polycarbonate | 47                          | 35                   | 12              | 25.5         |
| Dow Spectrum 50 (unwashed)      | 34                          | 29                   | 5               | 15           |
| (power washed)                  | 31                          | 23                   | 8               | 26           |
| (power washed, solvent wiped)   | 54                          | 31                   | 23              | 43           |
| GTX nylon-PPO Alloy             | 38                          | 35                   | 3               | 8            |
| Lexan FL-900 Polycarbonate      | 46                          | 45                   | 1               | 2            |
| Lexan LS2 Polycarbonate         | 50                          | 42                   | 8               | 16           |
| Noryl FN215 PPO                 | 46                          | 36                   | 10              | 22           |
| SMC (untreated, unwashed)       | 29                          | 24                   | 5               | 12           |
| (ready for painting)            | 40-52                       | 30-41                | 5-18            | 11-35        |
| TPO Bailey 3183                 | 35                          | 23                   | 12              | 34           |
| TPO Himont 3041C (flex)         | 33                          | 31                   | 2               | 6            |
| TPO Himont 3131 (inter.)        | 30                          | 29                   | 1               | 3            |
| TPO Himont 3183 (rigid)         | 38                          | 32                   | 6               | 16           |
| TPU/Estane                      | 39                          | 36                   | 3               | 8            |
| TESLIN PE/Silica                | 45                          | 45                   | 0               | 0            |
| Xenoy 1102U Polycarb./Polyester | 46                          | 38                   | 8               | 17           |
| Xenoy 2230 EU                   | 49                          | 38                   | 11              | 22           |

Source: Ref. 27.

They certainly did not fit the commonly held view that plastic surfaces have low polarities. Although two-component surface tensions are more complicated than critical surface tensions and from these results may appear to be less helpful, in fact, they usually give valuable information. Low total SST values indicate the possibility of wetting problems. Low polar components signal the possibility of adhesion problems and point to the need for surface treatment or an adhesion promoter. The same caveat that was given with the critical surface

tension table applies to this table: values are subject to change without notice! We have seen significant differences between test plaques and line parts and in day-to-day or week-to-week results on line parts. This is why it is crucial to paint and test actual parts and not totally rely on data from painted plaques.

The O-W-K method has been applied to a number of lab and field problems and has been found to be very useful in explaining and predicting wetting and adhesion failures (4,5,26). In addition, it has proved to be a good way to evaluate treatment and cleaning processes such as plasma treatment (34–36) and UV-ozone irradiation (37).

*Adhesion.* An example of results showing a correlation between polarities and adhesion are shown in Table 4, which deals with basecoat adhesion. The low polarity basecoats (after cure) gave good adhesion; the high polarity basecoats gave poor adhesion. Other tools for adhesion are listed in Section 5.6 and reference 38. Fourier Transform IR spectroscopy is useful for identifying contaminants and mold release agents on the plastic (perhaps initially detected by contact angle measurements).

*Three-Component SSTs.* SST also has been separated into three components: usually  $\gamma^d$ ,  $\gamma^p$ , and  $\gamma^h$ . These can be established by measuring contact angles with three pure liquids (23,39–42) or by wetting studies with a series of liquids (43,44). Note that the d, p, h notation (dispersion, polar, hydrogen bonding) is the same as that used for three-dimensional solubility parameters ( $\delta^d$ ,  $\delta^p$ ,  $\delta^h$ ). There is a good reason for this as there is a close relationship between these material properties (45–48) and a solubility parameter plot can be converted to surface units (43–47).

One three-component system that shows considerable promise is that of Good and coworkers (40–42) whose “three-liquid” procedure takes into account the acidic and basic nature of polymer surfaces. This system is based on two separate and additive attractive forces (dispersion and acid-base) operating

**TABLE 4** Adhesion and Solid Surface Tension

| Cured coating | Solid surface tension |                         |                     | Adhesion<br>Test |
|---------------|-----------------------|-------------------------|---------------------|------------------|
|               | Total                 | Dispersion<br>component | Polar.<br>component |                  |
| Old black     | 40                    | 30                      | 10                  | Failed           |
| New black     | 37                    | 33                      | 4                   | Passed           |
| Old silver    | 41                    | 31                      | 10                  | Failed           |
| New silver    | 40                    | 35                      | 5                   | Passed           |
| Red           | 42                    | 37                      | 5                   | Passed           |
| Undercoat     | 42                    | 38                      | 4                   | —                |



**TABLE 5** Three-Liquid Surface Parameters (surface energies – mJ/m<sup>2</sup>) Based on Advancing Contact Angles

| Polymer                              | $\gamma_{LW}$ | $\gamma^+$ | $\gamma^-$ |
|--------------------------------------|---------------|------------|------------|
| Polymethylmethacrylate (PMMA)        | 35.0          | 0          | 12.2       |
| Chlorinated polyvinylchloride (CPVC) | 45.2          | 0.24       | 3.1        |
| Polyvinyl fluoride (PVF, TEDLAR)     | 34.8          | 0.19       | 4.5        |
| Polypropylene (PP)                   | 32.6          | 0          | 0          |
| (Corona-treated)                     | 41.1          | 1.3        | 8.0        |
| (oxidized <sup>a</sup> )             | 39.1          | 0.26       | 33.2       |
| Polytetrafluoroethylene (PTFE)       | 19.6          | 0.28       | 3.2        |

<sup>a</sup>Different Polypropylene sample.

Source: Refs. 41, 49.

across an interface. The three components are  $\gamma^{LW}$  (Lifshitz–van der Waals),  $\gamma^+$  (electron acceptor), and  $\gamma^-$  (electron donor). The latter two can be thought of as forming an AB component resulting from acid-base interactions. Such an analysis should be useful for determining the effectiveness of surface treatments for plastics, characterizing pigment surfaces, and determining wetting interactions between paints and substrates.

With this procedure, contact angles of at least three liquids, one nonpolar and two polar, having known Lewis acidity and basicity are measured. From the results, data such as that shown in Table 5 can be calculated and the presence of acidic and basic sites established ( $\gamma^+$  for acidic and  $\gamma^-$  for basic).

These data indicate that the polymethylmethacrylate (PMMA) surface was basic and that chlorinated polyvinylchloride (CPVC) and polyvinyl fluoride (PVF) were both acidic and basic. Polypropylene was nonpolar, but corona treatment led to formation of acidic and basic sites. Another example of the effect of treatments on the surface of a plastic is shown in Table 6 (49). The surface activity of PVF was increased by plasma treatment, whereas corona treatment

**TABLE 6** Effect of Surface Treatments on Surface Tension Parameters (in mJ/m<sup>2</sup>)

| Material      | $\gamma_{LW}$ | $\gamma^+$ | $\gamma^-$ |
|---------------|---------------|------------|------------|
| PVF untreated | 38            | 0.02       | 13.2       |
| PVF corona    | 39            | 0.07       | 19.2       |
| PVF plasma    | 45            | 1.38       | 32.9       |

Source: Ref. 49.

had little effect. The results are based on contact angles with methylene iodide, water, and formamide.

Osterhold and Armbruster (50) applied the three-liquid method to coatings problems and showed that clearcoat wetting of dried basecoats correlated well to  $\gamma^{LW}$ , but not to the acid-base components or O-W-K results. Plastic surfaces also were examined. The O-W-K analysis showed a considerable increase in surface polarity of TPO on flame treatment. The three-liquid method confirmed this, but also showed that both acidic and basic sites had formed with the surface being predominantly basic.

It should be pointed out that you can learn only so much from contact angles. They can tell you that a surface is contaminated, difficult to wet, oxidized, otherwise changed, or a problem and even whether there are acidic and basic groups present. However, chemical analysis techniques must be used to identify what is actually on the surface. Also important is that wetting measurements are done at equilibrium at room temperature, whereas paint application and subsequent processes are dynamic and temperatures may vary. Therefore, something that looks good in the lab, may not work on the line or vice versa if line conditions are substantially different.

#### 5.2.2 Dewetting Tests

Lack of dewetting probably is a better test for predicting performance than is wetting. Two simple tests have been developed to determine the tendency for dewetting to occur on a substrate and to identify approximate critical surface tensions. One involves swabbing a series of solvents onto the substrate with cotton swabs and observing whether the strip of solvent stays in place or dewets and crawls (51). The breakpoint between wetting and dewetting provides a critical surface tension of dewetting. Surface tension "pens" that do much the same thing as the swabs are available commercially. The other test employs drops of solvent in much the same way (52,53). These tests can be carried out rapidly and are particularly useful for testing in the field or on curved or irregular surfaces where accurate contact angle measurements are not possible. Dewetting can be related to receding contact angles. Hansen (51,54,55) has covered this subject in some detail and has illustrated the concepts of spontaneous spreading and dewetting with plots such as those shown in Figure 17 (55). This figure shows the results of the measurement of advancing and receding contact angles on a substrate with a series of liquids of different surface tensions. The advancing angle plot (A-B-C-D) is a typical Zisman plot with points for four solvents and an intercept on the  $\cos \theta = 1$  line that gives the critical surface tension for spontaneous wetting. The receding angle plot (C-D-E) is based on angles measured as the solvent drops were slowly pulled back into the needle. This angle is lower than the advancing angle because the edge of the drop now is on a previously wetted area. The intercept of this plot gives a critical surface tension

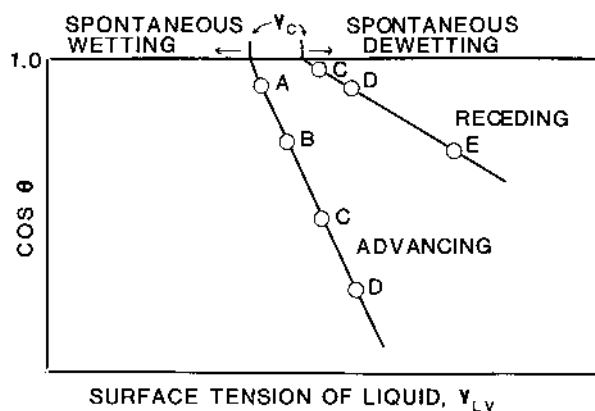

FIG. 17 Critical surface tension (Zisman) plots for advancing and receding contact angles. Liquid A wets the surface very well, B does not wet as well, but will not dewet. Liquids C, D, and E dewet. (From Ref. 5, used with permission.)

for spontaneous dewetting that nearly always is higher than that for wetting. Liquids A and B in Figure 17 do not spontaneously wet, but probably can be forced to wet fairly easily. They will not spontaneously dewet. Paints with their surface tensions would not be apt to give dewetting defects. On the other hand, liquids D and E do not want to wet the substrate and if force wet by smearing or swabbing would dewet. Paints with their surface tensions might well give crawling, edge-pull, poor edge coverage, and other defects. Liquid C is in between and might or might not dewet.

### 5.2.3 Viscosity Effects

Surface tension is not the only property that affects wetting and dewetting. The viscosity of the applied paint also influences wetting and surface defect formation. The rate of wetting is dependent on viscosity as well as surface tension (56). The equation is

$$\text{Rate of wetting} = (k \gamma \cos \theta) / 2\eta$$

Where k = a constant

$\gamma$  = liquid surface tension

$\theta$  = contact angle

$\eta$  = viscosity

Regarding dewetting, the amount of material that pulls back and the rate at which it does so are both dependent on viscosity (1). The velocity of the dewetting front is given by:

$$v = (\partial\gamma/\partial x) (h/\eta)$$

where  $\partial\gamma/\partial x$  is the surface tension gradient (the driving force for dewetting flow), which is defined as the difference in surface tension ( $\partial\gamma$ ) over a distance ( $\partial x$ ),  $h$  is the wet film thickness, and  $\eta$  is the viscosity. This equation also holds for the velocity of a crater wave front.

The rate of change of wet film thickness is

$$\partial h/\partial t = -\partial J/\partial x = -(h^2/2\eta) (\partial^2\gamma/\partial x^2)$$

which means that the rate of dewetting or crater formation depends on the viscosity and the change in the surface tension gradient. High viscosity means a low dewetting or crater formation rate. Taken together, these three equations tell us that even if other conditions are favorable (surface tension, contact angle, surface tension gradient, etc.), spontaneous spreading or dewetting/crater formation may not occur if the viscosity is too high.

#### 5.2.4 Other Effects, Tests, and Investigations

With some surface tension-related defects such as telegraphing, it rarely is practical to use surface tension and wetting methods for characterization. This is mainly because the dewetting and flow occur on such small scales (edges of scratches, fingerprint swirls, etc.). The problem usually responds to a combination of solvent wiping of the substrate and formulation changes to reduce flow. In the case of fiber telegraphing or read-through, the problem is more one of substrate swelling, although surface tension-driven flow may be involved as well. A primer that acts as a good barrier will reduce or prevent swelling by the topcoat solvents, although solvent changes may be necessary as well. Shrinkage of topcoats on cure can be a factor in both types of telegraphing. Overbaking of primer-surfacers makes the problem worse, possibly because this leads to a rougher surface to be painted by the topcoats.

Previously, it was mentioned that root cause analysis of craters usually is very difficult. That is true, but certain causes turn up again and again. One example is oil and water in compressed air. Water usually does not cause craters, but it is an excellent carrier for oil and droplets of oily water do give craters. Compressed air should be tested periodically for water and oil content using Dräger tubes or some other technique. At the point of paint application, there should be no oil detectable and the water level should be less than 150 mg/m<sup>3</sup>.

### 5.3 Tools for Volatile Defects

The light microscope is the most important tool, but often the specimen must be cross sectioned before it is clear whether the defect really is a pop and where it originates. Preparation of cross sections is an art in itself, but the results can be very useful. Thermogravimetric analysis (TGA) can be used to determine the

temperature of volatilization of components. The same technique can be used to simulate a bake and determine where and when the volatiles come off. Off-gases from the TGA or from a head space analyzer can be run into a gas chromatograph or mass spec for identification.

SMC gassing or blowout is usually due to porosity in the plastic. The porosity of SMC can be characterized through use of a dye penetration test (57,58). A small amount of dye is added to a topcoat or primer-surfacer that is then applied over primed and unprimed SMC (the latter as a control). A fluorescence microscope is used to observe the migration of the dye into the plastic. The distance that the dye travels can be determined by a calibrated eyepiece, photographing the image, or by image analysis. The further the dye goes, the more porous the SMC or the poorer the primer is as a sealer. This technique is used to characterize SMC and primers designed to seal the SMC surface.

#### 5.4 Tools for Flow Defects

There are many instruments and devices for measuring viscosity and it is easy to determine the flow properties of the paint that is in the can or drum (59–61). The difficulty is in determining the viscosity of the paint on the object that has just been painted and how this changes with time. One method is to apply the paint, then scrape it off and measure its viscosity. Besides being very tedious, this technique has poor repeatability and is not recommended. A technique that I have used extensively for coatings on metal, but only occasionally for coatings for plastics is rolling ball viscosity (5,59) in which paint is applied to a panel or plaque that is placed on an inclined plane (at an angle of 15–30 degrees). A small metal sphere (ball bearing) is rolled down the wet panel every 30 seconds or so until the paint sets up. The inverse of the velocity of the ball is a measure of viscosity. The technique has been useful for explaining flow and appearance differences, clearcoat soak-in, and a few cratering and popping situations.

Another method to measure flow properties after application involves the application of microdielectric measurements that have shown promise for characterizing film formation and cure (5,10–13). In this technique, the paint is applied to a thin, flat sensor connected to a frequency generator, an impedance analyzer and a computer. The sensor monitors the dielectric properties of the paint film at and near the interface between the sensor and the coating. The dielectric parameter used to estimate flow is called ion viscosity, but really is electrical resistivity rather than a true viscosity. Ion viscosity is a measure of both the number and mobility of ions in a specimen. It is affected by changes in temperature, loss of solvent, crosslinking and other chemical reactions, formation of physical structure (such as by a thixotrope), ionic impurities, and ionic additives. The advantage of this technique is that measurements can be made in situ during application, flash, and the bake.

### 5.5 Tools for Dirt Problems

Dirt reduction/prevention is a process that initially involves identification of the dirt on painted parts and root cause analysis to determine the source of the dirt. The latter can be very difficult. Dirt audits of paint plants and customer facilities help to identify current and potential dirt problems and sources. When done on a regular basis, they also allow measurement of whether efforts to reduce dirt are working or not. Another aspect of the process is to analyze dirt found in defects. It also is useful to collect dirt in a plant (carefully noting its source) and compare it to the dirt in defects. Removing dirt from defects takes a great deal of skill, but often is necessary in order to separate the dirt particle from its cocoon of paint (62,63). Cross sections also can be useful for enabling the investigator to actually see the dirt (Fig. 18). The key instrument for analysis is a light microscope. A small 40–60X microscope can be used on line for rapid identification, but analysis in the lab with a more sophisticated, but still low-power microscope almost always is more accurate. Cross sections usually are viewed at higher powers (100–300X). A dirt library with images of previously identified dirt can be helpful in characterizing new dirt, but analysis by scanning



FIG. 18 Cross section showing a clump of basecoat overspray in a clearcoat.

electron microscopy/energy dispersive x-ray (SEM/EDX) or IR microscopy often are necessary for accurate characterization. Even then, knowledge of what the dirt is does not do much good unless you can figure out where it is coming from.

A very valuable tool for handling dirt problems and preventing new ones is a plant Dirt Team. Such a group must have representatives from many areas: production, the paint shop, quality assurance, maintenance, paint suppliers, equipment and filter suppliers, etc. The team or individuals on it must have the authority to make changes in the process and its equipment, otherwise there will be a lot of discussion, but little will be accomplished.

Prevention of dirt problems requires clean raw materials; clean paint; a clean paint shop (isolated from the rest of the plant); a clean, dry air supply (environmental and compressed air); low-lint protective clothing and wiping cloths; and a properly trained, disciplined workforce. Sanding should be minimized and vacuum sanders should be used where possible. Dirt and dust should be removed by good tacking and wiping techniques and with effective blow-offs. Stored parts should be protected from dirt fallout. Entry to paint booths should be restricted to those who must be there (people = dirt). Booths should be kept clean, although there is considerable disagreement as to how often they should be cleaned. I have seen cleaning done as frequently as once a week and as infrequently as once a year. At most plants, the level of gun and bell maintenance needs to be raised. Ideally, a line should have two sets of gun tips and bells, one for operation, the other for preventive maintenance. Equipment should be cleaned during breaks within shifts as well as between shifts.

## 5.6 Tools for Field Problems

There are a number of tests that can be used to determine resistance to possible field damage and problems or to explain field failures. Although not aimed specifically at coatings for plastics, reference 20 gives a good general overview.

### 5.6.1 Adhesion

There are over 200 adhesion tests available, but only a few are used for painted plastics. Reference 38 describes several of them in detail. The most widely used test for coatings is the tape test (ASTM D 3359) in which an X-cut or lattice pattern is made in the film; pressure-sensitive tape is applied over the cuts and then rapidly removed; and adhesion is evaluated. As with virtually all adhesion tests, this test is sensitive only to large differences in adhesion. I do not believe that it is possible to make precise, accurate numerical comparisons between coatings with this test, but it works well for ranking coatings. Another class of tests is comprised of pull-off methods that measure the force needed to pull a coating from a substrate. ASTM D5179 uses a tensile tester to do the pulling and D 4541 employs a portable tester. Again, precision is disappointing. Other

tools for adhesion include the knife-edge scrape test (rub knife edge across surface), the solvent soak test (submerge an X-scribed test coupon in toluene/VM&P naphtha), and peel testing (58,64). Chip, scratch, and abrasion tests can be useful for evaluating adhesion, although mainly to show gross differences.

### 5.6.2 Mar and Scratch

There are a large number of mar-and-scratch tests. Some are attempts to recreate field damage such as from car washes; polishing and dry wiping; and general use and operation. Other tests involve the measurement of basic mechanical properties that should be useful in predicting resistance to marring and scratching stresses. Courter and Kamenetzky (65) evaluated a number of tests and their paper provides a useful comparison of methods. Many mar and scratch tests really are abrasion tests. They include a method using a reciprocating arm to rub a cloth back and forth over a dry abrasive on a panel (the crockmeter test, ASTM D 6279, and references 65–67), a similar test with an abrasive cloth, desk-top or floor-model car wash simulators, and the Taber abrader (ASTM D 6037, Method A). The degree of damage is determined from visual inspection, gloss measurements, and image analysis (68–72). Work of fracture tests (65–67) attempt to measure the toughness of the film. More recent nanoscratch techniques (65,73–75) measure the force to initiate a scratch and relate force and scratch depth to give what might be called a scratch modulus. Another relatively new method uses a modified scanning-probe microscope in one mode to stress the surface and in another to characterize the response (65,67,76,77).

### 5.6.3 Friction-Induced Damage (Gouging) on TPO

The standard technique for reproducing such failures in the lab is the Slido instrument (78,79) that applies a sliding stress to a painted panel using a half-cylinder probe. A wide range of forces can be applied and the device has heating capabilities to make the coating more sensitive to the sliding action. A Ford instrument called the Statram (80) and heated Taber abrader testing (GM test method 9911P) also have been used to simulate friction-induced damage. Resistance to gouging is dependent on the cohesive strength of the substrate and the mechanical properties of the coating, particularly the coefficient of friction (81).

## 6 CLOSING REMARKS

Perhaps the most daunting thing about painting plastics is the large number of things that can go wrong. Applying one complicated material (paint) to another (plastic) with a difficult-to-control process is not the way to make life easy for oneself. However, it is hoped that this chapter provides sufficient information and references to enable the reader to reduce the problems to a manageable few.



## REFERENCES

1. P Fink-Jensen. Surface disturbances in fluid paint films. *Farg och Lack* 8:5–14, 39–49, 1962. *Farbe Lack* 68:155–162, 1962.
2. CM Hansen, PE Pierce. Surface effects in coatings processes. *Ind Eng Chem Prod Res Dev* 13:218–225, 1974.
3. LO Kornum, HK Raaschou Nielsen. Surface defects in drying paint films. *Progr Org Coat* 8:275–324, 1980.
4. PE Pierce and CK Schoff. *Coating Film Defects*, rev. ed. Blue Bell, PA: Federation of Societies for Coatings Technology, 1994.
5. CK Schoff. Surface defects: diagnosis and cure. *J Coat Technol* 71(888):56–73, 1999.
6. LW Hill, K Kozlowski. Crosslink density of high solids melamine-formaldehyde cured thermoset coatings. *J Coat Technol* 59(751):63–71, 1987.
7. T Provder. Cure characterization in product research and development. *J Coat Technol* 61(770):33–50, 1989.
8. DJ Skrovanek. The assessment of cure by dynamic mechanical analysis. *Progr Org Coat* 18:89–101, 1990.
9. LW Hill. Structure/property relationships of thermoset coatings. *J Coat Technol* 64(808):29–41, 1992.
10. D Kranbuehl. In-situ cure monitoring of coatings for plastics. *Proceedings, Div Polym Mater Sci Engr, Amer Chem Soc*, 63:90–93, 1990.
11. DD Shepard. Studying the drying and curing rates of acrylic automotive topcoats using dielectric analysis. *J Coat Technol* 68(857):99–102, 1996.
12. D Kranbuehl, D Hood, C Kellam, J Yang. In-situ sensor for monitoring molecular and physical changes during film formation. In: T Provder, M Winnik, M Urban, eds. *Film Formation in Waterborne Coatings*, ACS Symposium Series No. 648. Washington: Amer Chem Soc, 1996, pp 96–115.
13. D Kranbuehl, D Hood, J Rogozinski, A Meyer, M Neag. Monitoring the changing state of a polymeric coating resin during synthesis, cure and use. *Progr Org Coat* 35:101–107, 1999.
14. RJ Hahn. Cratering and related phenomena. *J Paint Technol* 43(562):58–62, 1971.
15. CM Hansen, PE Pierce. Cellular convection in polymer coatings—an assessment. *Ind Eng Chem Prod Res Dev* 12:67–70, 1973.
16. G Bierwagen. Surface dynamics of defect formation in paint films. *Progr Org Coat* 3:101–113, 1975.
17. G Bierwagen. Surface defects and surface flows in coatings. *Progr Org Coat* 19: 59–68, 1991.
18. RHJ Blunk, JO Wilkes. Surface-tension-driven flows of coatings: bondline readout formation. *J Coatings Technol* 73(918):63–71, 2001.
19. RE Johnson Jr, RH Dettre. Wetting of low energy surfaces. In: JC Berg, ed. *Wettability*. Surfactant Science Series, vol. 49. New York: Marcel Dekker, 1993, pp 1–73.
20. DG Weldon. *The Failure Analysis of Paints and Coatings*. Chichester, England: John Wiley and Sons, 2000.

21. U Zorll. Practical matching controls for the adhesion properties of polymeric materials. *Intern Polym Sci Technol* 5(4):T/1–T/6, 1978 (orig. in *Gummi Asbest Kunst* 30(9):634–639, 1977).
22. H Potente, R Kreuger. The importance of the polar and disperse fractions of the surface tension of plastomers and coating materials for the adhesive strength of bonded systems. *Farbe Lacke* 84:72–75, 1978.
23. T Imai. New approaches to the problem of corrosion protection by means of organic coatings. In: GD Parfitt and AV Patsis, eds. *Proceedings of the 8th International Conference in Organic Coatings Science and Technology*, Athens, July 1982, pp 301–328; *Organic Coatings Science and Technology*, vol. 6. New York: Marcel Dekker, 1984, pp 325–350.
24. WA Zisman. Relation of the equilibrium contact angle to liquid and solid constitution. In: RF Gould, ed. *Contact Angle, Wettability and Adhesion*. *Adv Chem Series No. 43*. Washington: Amer Chem Soc, 1964, pp 1–51.
25. WA Zisman. Surface energetics of wetting, spreading, and adhesion. *J Paint Technol* 44(564):41–57, 1972.
26. CK Schoff. Wettability phenomena and coatings. In: ME Schrader and G Loeb, eds. *Modern Approaches to Wettability*. New York: Plenum Press, 1992, pp 375–395.
27. CA Kondos. *Plastics Substrates*. Unpublished Report. Allison Park, PA: PPG Industries, Inc., 1993.
28. GD Cheever. Evaluation of heterogeneous surfaces by contact angle distributions. *J Coat Technol* 58(732):37–42, 1986.
29. S Wu. Surface tension of solids: an equation of state analysis. *J Colloid Interface Sci* 71:605–609, 1979.
30. JR Dann. Forces involved in the adhesive process. I. critical surface tensions of polymeric solids as determined with polar liquids. *J Colloid Interface Sci* 32:302–320, 1970.
31. DK Owens, RD Wendt. Estimation of surface free energy of polymers. *J Appl Polym Sci* 13:1741–1747, 1969.
32. DH Kaelble. Dispersion-polar surface tension properties of organic solids. *J Adhesion* 2:66–81, 1970.
33. S Wu. Surface and interfacial tensions of polymers, oligomers, plasticizers, and organic pigments. In: J Brandrup, EH Immergut, EA Gilke, eds. *Polymer Handbook*, 4th Ed. New York: John Wiley & Sons, 1999, pp VI/521–VI/541.
34. M Osterhold, K Armbruster. Surface tension measurements and ESCA investigations on pretreated polymer samples. *Farbe Lack* 97:780–783, 1991.
35. H Gleich, H Hansmann. Low pressure plasma treatment for the systematic modification of surfaces of thermoplastic adherends. Part II: the analysis and evaluation of plasma-modified synthetic resin surfaces. *Adhäsion* 35(3):27–32, 1991.
36. Y Yao, X Liu, Y Zhu. Surface modification of high-density polyethylene by plasma treatment. *J Adhesion Sci Technol* 7:63–75, 1993.
37. AB Ponter, WR Jones Jr, RH Jansen. Surface energy changes produced by ultraviolet-ozone irradiation of poly(methyl methacrylate), polycarbonate, and polytetrafluoroethylene. *Polym Eng Sci* 34:1233–1238, 1994.

38. RA Ryntz. Adhesion to plastics: molding and paintability. Global Press, 1998, pp 109–124.
39. J Panzer. Components of solid surface free energy from wetting measurements. *J Colloid Interface Sci* 44:142–161, 1973.
40. CJ van Oss, MK Chaudhury, RJ Good. Interfacial Lifshitz van der Waals and polar interactions in macroscopic systems. *Chem Rev* 88:927–941, 1988.
41. RJ Good, CJ van Oss. The modern theory of contact angles and the hydrogen bond components of surface energies. In: ME Schrader, G Loeb, eds. *Modern Approaches to Wettability: Theory and Applications*. New York: Plenum Press, 1992, pp 1–27.
42. RJ Good. Contact angle, wetting, and adhesion: a critical review. *J Adhesion Sci Technol* 12:1269–1302, 1992.
43. CM Hansen. Characterization of surfaces by spreading liquids. *J Paint Technol* 42(550):660–664, 1970.
44. CM Hansen, E Wallstrom. On the use of cohesion parameters to characterize surfaces. *J Adhesion* 15:275–286, 1983.
45. LH Lee. Relationships between solubility parameters and surface tensions of liquids. *J Paint Technol* 42(545):365–370, 1970.
46. A Beerbower. Surface free energy: a new relationship to bulk energies. *J Colloid Interface Sci* 35:126–132, 1971.
47. AFM Barton. The application of cohesion parameters to wetting and adhesion—a review. *J Adhesion* 14:33–62, 1982.
48. AFM Barton. *CRC Handbook of Solubility Parameters and Other Cohesion Parameters*. Boca Raton, FL: CRC Press, 1983, pp 425–435.
49. TB Lloyd, KE Ferretti, J Lagow. A new approach to chemical characterization of polymer surfaces. *J Appl Polym Sci* 58:291–296, 1995.
50. M Osterhold, K Armbruster. Correlation between surface tension and physical paint properties. *Proceedings of FATIPEC XXIV, Interlaken, Switzerland, 1998, Vol. A*, pp 37–47.
51. CM Hansen. Surface dewetting and coatings performance. *J Paint Technol* 44(570): 57–60, 1972.
52. CM Hansen. Measuring surface tension: the droplet method. *European Coatings J* 94:838–845, 1994.
53. CM Hansen. A simple method to measure polymer surface tension. *Pigment and Resin Technol* 27:374–378, 1998.
54. CM Hansen. Receding contact angles and coatings performance: the  $\cos \theta_R$  plot. *Farg Lack* 22(11):373–377, 1976.
55. CM Hansen. Advances in the technology of solvents in coatings. *Proceedings of FATIPEC XIV, Budapest, June 1978*, pp 97–105.
56. RM Lukes. *Proceedings, Div Org Coat Plastics Chem, Amer Chem Soc* 41:7–10, 1979.
57. GD Cheever. Use of fluorescence microscopy in studying solvent transport in paint/substrate systems I. sheet molding compound (SMC). *J Coatings Technol* 60(762): 61–64, 1988.
58. WR Jones. The effect of substrate surface on coating selection. *Proceedings, Div Polym Mater Sci Engr, Amer Chem Soc* 63:68–72, 1990.

59. CK Schoff. *Rheology*. Blue Bell, PA: Federation of Societies for Coatings Technology, 1991.
60. RR Eley. *Rheology and Viscometry*. In: JV Koleske, ed. *Paint and coating testing manual*: 14<sup>th</sup> ed. of the Gardner-Sward Handbook. Philadelphia: ASTM, 1995, pp 333–368.
61. CK Schoff, P Kamarchik Jr. *Rheological measurements*. In: JI Kroschwitz, M Howe-Grant, eds. *Kirk-Othmer encyclopedia of chemical technology*, 4<sup>th</sup> ed., vol. 21. New York: John Wiley & Sons, 1997, pp 347–437.
62. KA Lockwood and SR Wickham. *Scientific dirt detection on the auto paint line*. *Mod Paint Coat* 78(7):36–40, 1988.
63. TJ Veneri, JA Kramer. *A new sample preparation technique for the examination and analysis of paint film defects*. *J Coating Technol* 66(829):23–29, 1994.
64. GD Cheever. *Role of surface morphology and composition in sheet molding compound (SMC) plastics*. *J Coatings Technol* 50(645):36–49, 1987.
65. JL Courter, EA Kamenetzky. *Micro- and nano-indentation and scratching for evaluating the mar resistance of automotive clearcoats*. *Eur Coatings J* 1999(7/8):3–38, 1999.
66. RA Ryntz, BD Abell, F Hermosillo. *Scratch resistance of automotive plastic coatings*. SAE Paper 980973. Warrendale, PA: SAE International, 1998.
67. RA Ryntz, BD Abell, GM Pollano, LH Nguyen, WC Shen. *Scratch resistance behavior of model coating systems*. *J Coatings Technol* 72(904):47–53, 2000.
68. B Pourdeyhimi, X Wang, F Lee. *Evaluation of scratch and mar resistance in automotive coatings*. *Eur Coatings J* 1999(3):72–79, 1999.
69. B Pourdeyhimi, ed. *Imaging and Image Analysis Applications for Plastics*. Norwich, NY: *Plastics Design Library*, a Division of William Andrew Inc., 1999.
70. F Lee, B Pourdeyhimi, K Adamsons. *Analysis of coatings appearance and surface defects using digital image capture/processing/analysis*. In: *Proceedings, The Intern. Symp. on a Systems Approach to Service Life Prediction of Organic Coatings*, Breckenridge, CO, September 14–19, 1997. *Service Life Prediction of Organic Coatings*. ACS Symposium Series 722. Washington: American Chemical Society, 1999, pp 207–232.
71. F Lee, B Pourdeyhimi, J Martin. *Comparative study of standard weathering test methods using image analysis*. In: *Durability 2000: Accelerated and Outdoor Weathering Testing*, ASTM STP 1385. West Conshohocken, PA: ASTM, 2000, pp 15–33.
72. F Lee, R Ryntz, D Britz. *Analysis of scratch resistance using optical imaging and automatic classification system*. In: *Proceedings (CD), Fourth International Coatings for Plastics Symposium*, Troy, MI, June 4–6, 2001.
73. L Lin, GS Blackman, RR Matheson. *A new approach to characterize scratch and mar resistance of automotive coatings*. *Proceedings, XXVth International Conference in Organic Coatings*, Athens, July 1999, pp 125–137. *Progr Org Coat* 40:85–91, 2000.
74. V Jardret, BN Lucas, W Oliver, AC Ramamurthy. *Scratch durability of automotive clearcoats: a quantitative, reliable and robust methodology*. *J Coatings Technol* 72(907):79–88, 2000.

75. U Schulz, V Wachtendorf, T Klimmasch, P Aler. Influence of weathering on scratches on automotive finishes. Proceedings of FATIPEC XXV, Turin, Italy, September 19–22, 2000. Vol. 4, pp 11–31. *Farbe Lack* 107:179–191, 2001.
76. W Shen, SM Smith, FN Jones, C Ji. Use of a scanning probe microscope to measure marring mechanisms and microhardness of crosslinked coatings. *J Coating Technol* 60(873):123–135, 1997.
77. FN Jones, W Shen, SM Smith, Z Huang, RA Ryntz. Studies of microhardness and mar resistance using a scanning probe microscope. *Progr Org Coat* 34:119–129, 1998.
78. RA Ryntz, D Mihora. The effect of coating composition on the friction induced paint damageability of painted thermoplastic olefins (TPO). SAE Paper 991205. Warrendale, PA: SAE International, 1999.
79. P Yaneff, K Adamsons, R Ryntz, D Britz. Structure/property relationships in flexible silane automotive coatings. In: Proceedings, International Waterborne, High-Solids and Powder Coatings Symposium, New Orleans, LA, February 21–23, 2001, pp 109–125.
80. RA Ryntz, D Britz, DM Mihora, R Pierce. *J Coatings Technol* 73(921):107–115, 2001.
81. RA Ryntz, M Everson, G Pollano. Friction induced paint damage as affected by clearcoat chemistry. *Progr Org Coat* 31:281–288, 1997.



# 7

## Recycling of Automotive Plastics

**Rose A. Ryntz**

Visteon Corporation, Dearborn, Michigan, U.S.A.

### 1 PLASTIC USAGE IN AUTOMOTIVE APPLICATIONS

Roughly 75% of a cars that have reached the end of their useful life, which typically runs 10 to 15 years, can be profitably recycled in the form of resalable parts and scrap metals (1). Each year, an estimated 11 million vehicles are scrapped in the United States, generating some 2.5 billion pounds of discarded automotive plastics (2). Globally, approximately 2.2 million tons per year of plastics in automotive shredder residue goes to landfills (3). Efficiently processing the approximately 250 pounds of more than 20 types of plastics is one of the biggest problems in recycling. While some automotive plastic parts such as tail lamps, fenders, bumper covers, wheel covers, and interior trim are reused, the majority of automotive plastics are landfilled.

Automotive original equipment manufacturers (OEMs) are realizing the benefits that plastics can provide in car design—the flexibility, the functionality, and the potential for weight and cost savings. Plastics have come a long way since their discovery and development in the late 1800s (Table 1) (4). Bakelite, created in 1907 by Leo Baekeland, was the world’s first true synthetic fiber. In 1990, Dr. Jacques Edwin Brandenberger developed cellophane, a clear protective packaging layer. Several discoveries in the 1920s and 1930s established the profile of thermoplastic resins, for example, poly(ethylene), but it was the discovery of nylon, by Wallace Hume Carothers, that led to the development of engineering resins. Today the plastics industry is the fourth largest manufacturing industry in the nation, which employs approximately 1.4 million people.

**TABLE 1** Development of Plastic Materials

| Development of Plastics Timeline |   |                               |
|----------------------------------|---|-------------------------------|
| 1862                             | → | First manmade plastic         |
| 1866                             | → | Celluloid debut               |
| 1891                             | → | Rayon discovered              |
| 1907                             | → | Bakelite invented             |
| 1913                             | → | Cellophane and plastics craze |
| 1926                             | → | PVC comes along               |
| 1933                             | → | Polyethylene                  |
| 1933                             | → | Saran debut                   |
| 1938                             | → | Teflon discovered             |
| 1939                             | → | Nylon stockings               |
| 1957                             | → | Velcro                        |

Plastics are synthetic materials called polymers, which are long-chain molecules made up of repeating units joined together. These units contain various combinations of oxygen, carbon, hydrogen, nitrogen, silicon, chlorine, fluorine, and sulfur. Although plastics are soft and moldable and approach a liquid condition during manufacture, they are solid in their finished state. As more repeating units are added, the plastic's molecular weight increases. As molecular weight increases, for example from pentane ( $C_5H_{12}$ , a liquid) to poly(ethylene) ( $C_{100}H_{202}$ , a widely used thermoplastic material), the mechanical and physical properties of the plastic change. The mechanical and physical properties of plastics are



directly related to the bonds between molecular chains, the molecular weight and molecular weight distribution of the chains, as well as to the composition of the elements contained within the molecular chains. Plastic properties can also be modified both by alloying and by blending in various substances and reinforcements.

### 1.1 Plastic Classification

The classification of plastics can generally be combined into two major groups: thermoplastics, which are moldable and fusible, and thermosets, which are cross-linked and infusible. In addition to these broad categories, polymers can be classified in terms of their structure, for example, crystalline, amorphous, and liquid crystalline. Other classes of plastics commonly referred to are copolymers, alloys, and elastomers. Finally, additives, reinforcements, and fillers, play a major role in modifying properties.

#### 1.1.1 Thermoplastics

Thermoplastics are resins that repeatedly soften when heated and harden when cooled (conditions that refer to “fusibility”). Most thermoplastics are soluble in specific solvents and can burn to some degree. Softening temperatures vary with the polymer type and grade. Care must be taken in application conditions not to exceed the heat distortion temperature of the plastic, wherein the plastic begins to soften and potentially warp. Typical thermoplastics utilized in the automotive arena include, poly(olefins)—for example, poly(propylene) (PP) and poly(ethylene)—nylon, acrylic, acetal, poly(styrene), poly(vinyl chloride) (PVC), poly(sulfone), and the like. Also within this group are highly elastic, flexible resins known as thermoplastic elastomers (TPEs).

#### 1.1.2 Thermosets

Thermosets are plastics that undergo chemical crosslinking during processing to become permanently insoluble and infusible. Phenolic, amino, epoxy, and unsaturated polyester resins are typical thermoset plastics. Natural and synthetic rubber such as latex, nitrile, millable poly(urethane), silicone, butyl, and neoprene, which attain their properties through a process known as vulcanization, are also thermoset plastics.

The structure of thermoset plastics is very similar to thermosets prior to molding. However, during fabrication, crosslinking occurs between adjacent molecules, resulting in a complex, interconnected network. These crosslinks prevent the individual chains from slipping, thus preventing plastic flow when heat is added. If excessive heat is added to the polymer after the crosslinking is complete, the polymer degrades rather than melting.

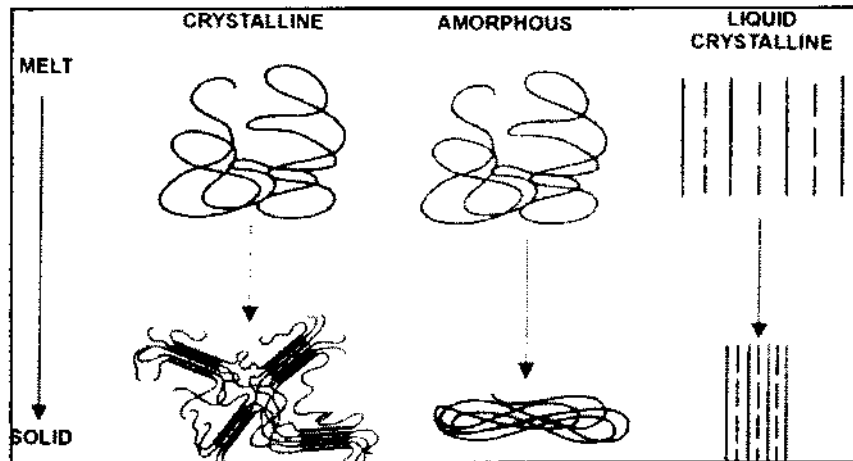

Fig. 1 Crystalline, amorphous, and liquid crystalline structures.

## 1.2 Crystalline, Amorphous, and Liquid Crystalline Polymers

In some thermoplastics, the chemical structure allows the polymer chains to fold on themselves and pack together in an organized manner (see Fig. 1). The resulting organized regions show the behavior characteristics of crystals. Plastics that have these regions are called crystalline. All of the crystalline plastics have amorphous regions between and connecting the crystalline regions. For this reason, crystalline plastics are often called semicrystalline in the literature. Table 2 gives some examples of crystalline and amorphous plastics utilized in the automotive industry.

Liquid crystalline polymers are best thought of as being a separate and unique class of plastics. The molecules are stiff, rod-like structures that are organized in large parallel arrays or domains in both the melt and the solid

TABLE 2 Exemplary Automotive Plastics

| Crystalline                | Amorphous                             |
|----------------------------|---------------------------------------|
| Acetal                     | Polystyrene                           |
| Nylon                      | Acrylonitrile-butadiene-styrene (ABS) |
| Polyethylene               | Styrene-acrylonitrile (SAN)           |
| Polypropylene              | Polycarbonate                         |
| Polyethylene terephthalate | Polyvinylchloride                     |

states. These large, ordered domains provide liquid crystalline polymers with unique characteristics compared to those of crystalline and amorphous polymers.

Many of the mechanical and physical property differences between plastics can be attributed to their structure. In general, the ordering of crystalline and liquid crystalline thermoplastics makes them stiffer, stronger, and less resistant to impact than their amorphous counterparts. Crystalline and liquid crystalline materials are also more resistant to creep, heat, and chemicals. However, crystalline materials require higher melt temperatures to process, and they tend to shrink and warp more than amorphous polymers. Amorphous polymers soften gradually and continuously as heat is applied, and in the molding process they do not flow as easily as melted crystalline polymers. Liquid crystalline polymers have the high melt temperature of crystalline plastics, but soften gradually and continuously like amorphous polymers. They have the lowest viscosity, warpage, and shrinkage of all thermoplastics (see Table 3).

### 1.3 Copolymers

A copolymer is a polymer made with two or more different kinds of repeating units. A terpolymer is a copolymer with three different kinds of repeating units. When a polymer family includes copolymers, as with acetal resins, the term *homopolymer* identifies the polymer with a single type of repeating unit. Copolymers can have different properties from those of the homopolymers making up either repeating unit.

### 1.4 Alloys

Alloying is another way to create tailored variations in plastics. Though a generally accepted definition does not exist to define exactly what a plastic alloy is,

**TABLE 3** Generalized Properties of Plastics

| Property               | Liquid crystalline | Amorphous | Crystalline |
|------------------------|--------------------|-----------|-------------|
| Specific gravity       | Higher             | Lower     | Higher      |
| Tensile strength       | Higher             | Lower     | Highest     |
| Tensile modulus        | Higher             | Lower     | Highest     |
| Ductility, elongation  | Lower              | Higher    | Lowest      |
| Resistance to creep    | Higher             | Lower     | High        |
| Max. usage temperature | Higher             | Lower     | High        |
| Shrinkage/warpage      | Higher             | Lower     | Lowest      |
| Flow                   | Higher             | Lower     | Highest     |
| Chemical resistance    | Higher             | Lower     | Highest     |

it is accepted that alloys are combinations of polymers that are mechanically blended. They do not depend upon chemical bonds, but often require special compatibilizers to join different constituent polymers together to improve performance, to lower cost, or to improve processability.

Generally, the properties of plastic alloys fall between those of the starting polymers. However, some alloys are able to achieve a synergistic combination that is better than the properties of either component alone.

### **1.5 Elastomers**

Thermoplastic elastomers are generally lower modulus, flexible materials. Thermoset rubber materials have been available for a long time, but currently many families of injection-moldable TPEs are replacing traditional rubbers. In addition, TPEs are widely used to modify the properties of rigid thermoplastics, usually improving the impact strength.

### **1.6 Additives, Reinforcements, and Fillers**

Adding a wide variety of fillers, fibers, and other chemical components can also modify the physical and mechanical property profile of plastics. In general, adding reinforcing fiber most significantly increases mechanical properties, although with the onset of “nanotechnology” the jury is still out. Particulate fillers usually increase modulus, and plasticizers usually decrease modulus and enhance flexibility. Flame retardants, thermal and ultraviolet (UV) stabilizers, and oxidation inhibitors are other common additives, especially those that are conductive. When the mechanical properties are improved, the resin is called a reinforced resin. An example is glass-filled nylon. When the additive does not significantly improve the mechanical properties, but does affect the physical nature of the material, the plastic is usually called a filled material. An example is a mineral-filled polyester. Table 4 lists a variety of common plastic fillers, reinforcements, and other additives.

## **2 TYPES OF PLASTICS UTILIZED BY APPLICATION**

The demand for everything from soft-touch interior surfaces to molded-in-color body panels in conjunction with regulatory pressures is leading automakers to push for the use of more plastics in every part of the car. In addition to the styling latitude and weight reduction that plastics offer, cost reduction may also be a driver, particularly in areas where secondary finishing techniques (e.g., painting) can be eliminated. New system and modularization concepts, taking shape on the OEM and supplier’s drawing boards, are coming closer to maturation, acceptance, and production. They are expected to greatly expand the contributions of plastics in upcoming new vehicles.

**TABLE 4** Common Fillers, Reinforcing Fibers, and Additives for Plastics

| Fillers              | Reinforcing fibers | Other additives     |
|----------------------|--------------------|---------------------|
| Glass spheres        | Glass fibers       | UV stabilizers      |
| Carbon black         | Carbon fibers      | Plasticizers        |
| Metal powders        | Aramid fibers      | Lubricants          |
| Silica sand          | Jute               | Colorants           |
| Wood flour           | Nylon fibers       | Flame retardants    |
| Ceramic powders      | Polyester fibers   | Antioxidants        |
| Mica flakes          |                    | Antistatics         |
| Molybdenum disulfide |                    | Preservatives       |
| Nano-clay            |                    | Processing aides    |
|                      |                    | Fungicides          |
|                      |                    | Smoke suppressants  |
|                      |                    | Foaming agents      |
|                      |                    | Viscosity modifiers |
|                      |                    | Clarifiers          |
|                      |                    | Impact modifiers    |
|                      |                    | Odor reducers       |

## 2.1 Under the Hood

Increased efficiency, including the need to more tightly pack the engine compartments, are driving the evaluations of high-temperature plastics for underhood applications, including poly(phenylene sulfide) (PPS), liquid-crystal polymers, and acetal copolymers.

Increased recognition of the ability of selected thermoplastics to withstand demanding combinations of high mechanical loads, wide temperature variations, and chemicals is demonstrated by the use of PPS in a brake-system air valve.

Underhood stresses are also managed with up to a 100% recycled-content glass and mineral-filled polyethylene terephthalate (PET) polyester cover that protects the throttle linkage, pressure sensor, and air resonator sensor.

Integration of an air cleaner, resonator induction, and composite intake manifold has been accomplished through the use of nylon-6. Other applications include an intake manifold featuring integrated fuel passages, which replace self-standing fuel rails.

Integration of a Helmholtz resonator, a tuning device utilized to neutralize and therefore attenuate noise, mounted on an intake manifold or on an air cleaner, has been introduced in nylon-6,6 or nylon-6. Coupling the engine elec-

tronic controls units (ECU) into the products accounts for the elimination of tubes and fasteners.

Nylon has made significant inroads from 10 years ago. According to some estimates, underhood applications for nylon in the United States and Canada are projected to grow in 2007 to 4.9 million pounds for engine rocker arm covers; 59.6 million pounds for engine air intake manifolds; 5.2 million pounds for engine oil pans; and 1.9 million pounds for engine covers (5).

The "Partnership for Carpet Reclamation" has collected approximately 27 million feet (2) of commercial carpeting annually to utilize in air cleaner housings. The air cleaner application of mineral-reinforced nylon-6,6 utilizes 25% postconsumer polymer recycle.

## 2.2 Behind the Fascia

While plastics have been established as the material of choice for automotive fascia design efforts to provide more simplified, integrated bumper systems continue. Integration of the traditional steel or aluminum frame and impact-absorbing foam or honeycomb components has been achieved utilizing lightweight injection molded poly(carbonate)/polyester alloy or blow-molded poly(olefin).

Poly(propylene) continues to demonstrate steady growth in automotive applications. In North America, forecasts are that the material's use will climb to more than 500 million pounds by 2009 (6). The average vehicle will use more than 30 pounds of thermoplastic olefins (TPOs) by 2009, up from about 24 pounds today. Some trucks and sport utility vehicles will use even more, topping more than 100 pounds per vehicle.

The TPOs are a blend of ethylene-propylene impact copolymer and elastomer. They can be painted through use of conventional adhesion promoters or through the application of a flame pretreatment. They may also be molded-in-color, for example, as they are on the DaimlerChrysler AG's Jeep Liberty front and rear fascias, wheel frames, mud flaps, and outer body panels. Nearly 50% of the exterior body surface on General Motors Corporation's Chevrolet Avalanche is TPO.

Complex reflectors within new vehicle headlamp assemblies typically must withstand temperatures of up to 400°F. Appropriate thermoplastic materials must be selected not only for the lamp backcan and lens, but also for the electronic/electrical connectors. Variations on filled polyester, poly(imides), bulk molding compound (a sheet molding compound [SMC] analogue), and nylon/poly(phenylene oxide) alloys are typically utilized in these applications. Poly(carbonate) (PC) or impact-modified PC is typically used in the lens applications where high heat is required. Acrylic plastics can and are most typically utilized in lens applications that do not require high heat, such as rear stop mount designs.

### 2.3 Exterior Body Panels

Body panels, structures, and underhood applications of SMC (a polyester-styrene glass-reinforced thermoset) can be found on more than 30 new cars and trucks made by automakers in North America and elsewhere. The number of SMC components has risen about 50% since 1993. Highlights include the hood on the Lincoln Navigator sport utility vehicle, adding to the more than 25 SMC hoods on current production vehicles. The SMC Automotive Alliance says that the savings in weight and tooling costs, plus design flexibility, has also driven the growth of the material in heavy duty trucks. Hoods, fenders, grilles, and accent bars can account for as much as 150 pounds of SMC per vehicle. New applications include decklid and tonneau covers, fuel tank heat shields, and pick-up beds and tailgates.

Recent advances in poly(urethane) reinforced reaction injection molded (RRIM) parts has led to use in components such as fenders for small trucks, low-density interior door panels, and higher heat-resistant body panels. Rear fenders on the Chevrolet Silverado and the GMC Sierra trucks (Fig. 2), made of RRIM polyurea, are the first application of a RRIM polymer designed to withstand electrocoat, primer, and topcoat paint line process temperatures.



FIG. 2 Chevrolet Silverado RRIM fenders. (From Ref. 7, used with permission.)

## 2.4 Plastic/Metal Hybrids

Prototypes for modular design of plastic-metal hybrid components have resulted in modular front-end component implementation on the 1996 European Ford Focus, the 1999 North American Ford Focus, the 1994 Audi A6, and 1997 Audi A2. The concept utilizes an injection-molded nylon housing overmolded onto a steel frame, which encompasses the modular front end. Other applications of such technology have been extended to seats, being incorporated into the 1992 Mercedes-Benz Viano seat.

## 2.5 Blow-Molded Applications

Fuel tank applications utilizing coextruded blow-molded “layers” of ethylene vinyl alcohol (EVOH) in conjunction with high-density polyethylene (HDPE) have been in place for decades. In these applications, the EVOH layer is adhesively bonded to the HDPE with an acrylic copolymer adhesive. The EVOH acts as an impermeable membrane to gasoline and additives such that the emission permeation requirements for fuel tanks is met.

Other applications utilizing blow-molding technology include front-bumper beams, rear-window shelves, and air ducts under instrument panel structure. Blow molding is utilized in these applications due to substantially lower tooling costs over injection molding.

## 2.6 Interior Trim

Interior trim applications encompass components such as door skins; A, B, and C pillars; as well as center consoles and add-on bezels. Several plastic types are utilized, with the majority of the applications now seeking lower cost through the use of mold-in-color polyolefins.

Injection molded instrument panels are most often described as “hard” or “soft” panels, an attribute identified by the surface tactile feel. Hard instrument panels are generally produced from either polycarbonate/acrylonitrile-butadiene-styrene (PC/ABS) blends (which are subsequently painted), or impact-modified TPO (a blend of polyolefins that are rubber modified) (which are subsequently painted or molded-in-color).

Soft instrument panels are generally comprised of a structural beam, which is either painted with a “soft-feel” coating or overmolded with a soft skin. The structural member of the instrument panel is generally comprised of a talc-filled styrene-maleic-anhydride, poly(phenylene oxide), glass-filled PP, or impact-modified PC. Each of these substrates can then be either painted or “skinned” to achieve the “soft-feel.”

Paint application, described later in this chapter, provides the desired feel through the use of a urethane coating modified with soft-urethane gels that act



as pigments. If the structural component to be painted is of low surface energy, for example, PP, a surface modification of the component is necessary prior to painting. The surface modification consists of either flame or plasma pretreatment or adhesion promoting primer.

Skins, applied generally as foam-modified composites, usually consist of thermoplastic urethane (TPU), TPO, or PVC. Skins can either be cast or extruded and then laminated to the structural substrate. Foams are generally an integral part of the laminated skin or they are injected between the skin and the substrate in a subsequent process. Foam materials generally include poly(urethane) or PP. Paint is generally required on the skin to prevent surface damage of the substrate, color harmony, or to stop migration of plasticizers generally contained within the skin material.

Door applications generally mimic those of instrument panels in the materials utilized, but differ in the process utilized to form them. While instrument panels are injection molded, doors are usually processed using low-pressure compression/injection molding. Fabrics can be applied to the door module in this way, if desired.

For implementation in soft component, a relatively new technology from Trexel, MuCell, that utilizes supercritical fluids of atmospheric gases (CO<sub>2</sub> and N<sub>2</sub>) to create evenly distributed and uniformly sized (5 to 50 micron) cells throughout the thermoplastic polymer (8) has been introduced. Clamp tonnage reduction and increased productivity due to reduced processing times have been attributed to this technology in injection molding applications.

Interior A, B, and C pillars are generally comprised of ABS or impact modified PP. With the advent of new FVMSS side-impact and head-impact requirements, more materials are moving toward an impact-modified grade of poly(olefin). Such components may be molded-in-color or painted to achieve the desired color harmony and aesthetic feel. Special-effect "coatings" to achieve the feel of flocking are achieved through lamination of a flocking to the component prior to installation.

Center consoles, which in the past were notoriously comprised of painted ABS, are now migrating toward mold-in-color PP to achieve weight and cost savings. Traditional consoles that were "soft" in feel were achieved through the same concepts previously described for instrument panels.

Add-on bezels may be composed of many materials, to include poly(carbonate), ABS, PP, and the like. Depending upon the design considerations, the part may be molded-in-color or painted.

### 3 COATING TYPES UTILIZED

Formulators continue to develop more durable, high-performance coatings based on the increasing mandates of environmental regulations. Maintaining cost-

competitiveness, in spite of the increasing cost of raw materials, is also a major challenge facing the coating formulator.

In the United States, the consumption of coatings systems over the past decade continues to rise, following similar trends as those experienced in Europe. While conventional solventborne coatings continue to be the most commonly used and still hold the largest share of the market, powder and waterborne coatings are expected to continue to gain ground within the ensuing years.

### 3.1 Environmental Constraints

Regulatory pressures to reduce volatile organic compounds (VOC) emissions continue to fuel increased use of compliant coatings. Environmental constraints imposed by local, state, and federal governments reflect the following concerns (9):

1. Treating the earth as one biosphere, having a finite capacity for cleaning itself of toxins.
2. Cleaning air from pollutants that are killing lakes and causing a dramatic increase in respiratory illness.
3. Ensuring that smog-enshrouded cities do not become industrial nightmares.
4. Making the agricultural and livestock products that people eat safe for consumption over the long term.

These concerns have led to legislation over the last several years that causes manufacturers to place a greater emphasis on research to meet and exceed government and consumer demands for clean air.

#### 3.1.1 Selecting Compliant Coatings

The environmental demands have led to a nationwide program, the revised Clean Air Act of 1990, which limits the VOCs in a paint. The VOCs of paint are calculated as pounds of solvent per gallon of paint. Prior to 1970, the VOC content of most paints was well above 5 lb/gal. Current major industrial paints are now limited to approximately 3.5 lb/gal of VOC because of imposed environmental pressures. Stricter legislation in the future is likely to push the VOC limits even lower.

The issue of air-quality compliance is complicated by different regulations in various states and regional areas. Although the federal government (through the U.S. Environmental Protection Agency [EPA]) has set minimum national standards, states and designated regional areas can adopt their own compliance rules. The EPA activities for putting the Clean Air Act Amendments (CAAA) of 1990 into effect include:

1. Preparing new Control Technique Guidelines (CTGs);
2. Developing rules to limit emissions of toxic air pollutants through a program referred to by two names, National Emission Standards for

Hazardous Air Pollutants (NESHAPs) and Hazardous Air Pollutants (HAPs); and

3. Studying emissions from consumer and commercial products.

The EPA has scanned the marketplace to find out about available technology in an attempt to put in place CTGs. The CTGs are designed to cut VOC emissions without imposing an unreasonable financial burden on companies required to buy pollution-reduction technology. A CTG is a document prepared by the EPA to assist states in defining Reasonable Achievable Control Technology (RACT) for major sources of VOC.

The plastic parts coating CTG addresses the coating of plastic parts for automotive/transportation, business machines/electronic equipment, and other miscellaneous issues. The plastic parts CTG limits paints by category, for example, by low-bake (<194°F) and high-bake (>194°F) conditions, as well as by interior, exterior, and specialty coatings.

Also included in regulatory compliance is the issue of hazardous wastes. On March 29, 1990, the U.S. EPA promulgated a final rule revising the procedure used to determine whether wastes are hazardous because of their potential to leach significant concentrations of toxic constituents to landfills (10). The extraction procedure (EP) toxicity characteristic procedure was replaced with the Toxicity Characteristic (TC), utilizing the Toxicity Characteristic Leaching Procedure (TCLP) (11). Included in the U.S. EPA list are 25 commonly used organic chemicals in the surface finishing industry such as tetrachloroethylene, ethylene glycol ethers, and the like. This law severely restricts the coating formulator in the type of solvent utilized to fully formulate a VOC-compliant material.

Through the years, improved paints have been developed because of competition from environmental and consumer activists. The objective of improving overall quality and reducing emissions (VOCs) has led to a wider selection of paint types. The user, therefore, must select a coating type that meets the cost of required application, equipment, energy costs for using, pollution and waste collection expenses, and application and cured performance requirements of the coating.

The introduction of new federal regulations can delay the implementation of new and improved ingredients to replace higher-VOC materials. These include the following mandates (12):

1. By November 1, 2003, virtually all coatings must be reformulated to meet new Maximum Achievable Control Technology (MACT) standards with nonstandard paint lines.
2. At the same time, the industry must eliminate any ingredients that are considered HAPs.
3. Any new technology must meet Significant New Use Requirements, which complicates changing ingredients.

4. Nuisance regulations now allow a neighboring resident to shut down an assembly line if the new ingredients produce an unfamiliar odor, regardless of whether the ingredients meet new regulations.

### 3.2 Current Automotive Trends

Until 1965 automotive topcoats consisted of nothing more than acrylic lacquer technology. As technology improved, the use of solvent-based nonaqueous dispersions became the norm (1970s), followed by medium-solids thermoset systems in the early 1980s. The advent of crosslinked systems in automotive applications allowed the formulator to achieve higher chemical resistance standards while maintaining the lacquer-like appearance. By the late 1980s however, two competing factors were becoming important: control of VOC and the quality and appearance of the topcoat. As the VOC limit was reduced, the molecular weights of the solvent-based resins decreased so that formulated paints would become more soluble in organic solvents, and hence require less of them. As a result, the tendency of the low-molecular weight topcoat chemistries to sag on vertical body panels after application, and prior to chemical crosslinking and cure, became an increasing problem. Resin and solvent producers worked on alternative chemistries to enhance rheological characteristics of the formulated coatings (e.g., through incorporation of "sag" control agents), while solvent manufacturers looked closely at solvent characteristics (e.g., evaporation profiles, solubility parameters) in hopes of meeting the demands for "less of a more compatible solvent."

Concurrently, automotive demand for increased plastic usage became standard when legislation mandated that automobiles should sustain little or no damage in low-speed collisions. The average weight of plastic utilized in the late 1960s, namely less than 50 pounds per car, jumped dramatically in the 1980s to approximately 250 pounds per car when bumpers, fascias, rub strips, and the like mandated plastic as the material of choice.

Today, the environmental constraints and quality requirements placed on coating manufacturers is even more demanding. Solids levels of formulated solventborne coatings are expected to be on the level of 60% by weight or higher, which often forces the use of reactive diluent technology, water, or powder. The rising quality standards by the automobile manufacturers mandate improvements in durability, chemical resistance, mechanical and physical property enhancements (e.g., chip, mar, and scratch resistance), and the like. Appearance standards are becoming more closely monitored, in that color measurement is now defined not only in terms of hue and chroma, but more finely described in terms of acceptance tolerance in "color space." Metallic glamor standards have risen with the use of waterborne basecoat technology. Special-effect pigments are tantalizing the stylists with new concepts. All in all, the ability to reach these

new levels of acceptance standards is only achieved through the development of new resin, pigment, and quality control technology.

### 3.2.1 One- and Two-Component Systems

Solvent- and water-based coatings generally consist of the same basic ingredients: resin, crosslinker, rheology control agent, catalyst, pigment(s), flow and leveling additives, and solvent(s). Water-based resins often require neutralizing agents (pH buffers), as well as antimicrobials, to keep them free of bacterial growth and in solution. The pigments utilized can be comparatively similar, with the exception of those pigments that chemically react with water, for example, aluminum. These pigments require a special pretreatment prior to incorporation into the water-based formulations.

*Crosslinkers.* The choice of crosslinker utilized in a coating formulation can influence such coating properties as flexibility, hardness, impact resistance, solvent resistance, weatherability (e.g., UV resistance and humidity resistance), and intercoat adhesion. Melamine crosslinked systems (discussed in the following text), for example, will generally demonstrate greater hardness, solvent resistance, and intercoat adhesion, versus comparably crosslinked isocyanate-based systems. The amount of crosslinker utilized, generally falling within the range of 20% to 40% by weight, based-on-resin-solids (bors), can influence cost, rheological properties, and solids levels, in addition to the previously described properties.

The types of crosslinkers utilized in the formulations of coatings for plastics are generally classified as one package or one-component (1K, "K" being German for "komponent"), or two-component systems (2K). In the 1K systems, the crosslinker, resin binder, and additives are all premixed in one package, having adequate "shelf-life" (defined as the time/temperature during which the coating maintains its desired application properties) for the required application. In the corresponding 2K formulations, the resin binder and additives (generally including catalyst to enhance the rate at which crosslinking occurs) are premixed in part A, in a separate container, and is placed part B, containing the crosslinker with solvent (if required for viscosity adjustment). The two parts are then admixed just prior to application in that the crosslinking reaction between the two components begins to take place after mixing. The corresponding "shelf-life" of a 2K system is referred to in terms of gellation time after mixing. A general rule of thumb is that the 2K "shelf-life" after mixing should fall within a 4- to 8-hour interval at ambient conditions.

The types of resins that comprise 1K crosslinkers are generally of the aminoplast family of blocked isocyanates.

1. The major crosslinker type utilized in 1K coatings is an aminoplast resin, with the melamine formaldehyde (MF) types the overwhelming favorite

of many formulators. The degree of methylation ( $-\text{CH}_2\text{OH}$ ) and etherification ( $-\text{CH}_2\text{OR}$ ) of an aminoplast resin are the major factors in determining the behavior and specific characteristics of the crosslinker. The crosslinking reaction of an aminoplast resin and a binder is usually accomplished through hydroxyl-functionality of the resin and the methylol or etherified methylol group on the aminoplast, resulting in an half-acetal, half-aminal crosslink with subsequent water or alcohol evolution. The crosslinking reaction can be acid or base catalyzed and generally requires temperatures in excess of  $113^\circ\text{C}$ , more realistically  $121^\circ\text{C}$ , for 20 to 30 minutes. Several side reactions can occur if the temperatures of cure become too high, one of which includes the self-condensation of the MF resin, which can result in embrittlement of the coating. As the amount of formaldehyde, in the form of methylol functionality, on the aminoplast resin increases, the viscosity of the resin decreases (allowing one to formulate higher solids systems), the hydrolytic stability increases, stronger acid catalysis is required for crosslinking, and water solubility decreases. The flexibility of resins formulated with MF resins can be controlled through the degree of polymerization of the crosslinker, for example, the amount of self-condensation between the MF rings. The major disadvantages of MF chemistry lay in their high heat requirement for crosslinking and in the fact that the half-acetal, half-aminal linkage that is formed upon crosslinking with an acrylic-polyol or polyester resin is very susceptible to environmental etch. It has been shown, however, that when certain MF-cured coatings are exposed to UV irradiation after cure that the environmental etch resistance can increase (13). Solomon provides an excellent reference on the chemistry of MF resins (14).

2. Another 1K crosslinker that can be utilized by the formulator is a blocked isocyanate. Blocked isocyanates are simply isocyanates that have been reacted with a suitable blocking agent (15). Blocking agents include such reagents as caprolactam, phenol, and methyl ethyl ketoxime. The crosslinking reaction requires temperatures to reach or exceed the deblocking temperature of the blocking agent, often in excess of  $150^\circ\text{C}$ , before reaction of the unblocked isocyanate with the hydroxyl functional resin can proceed. The coating produced through this chemistry will have all of the attributes associated with the urethane bond formed through the isocyanate chemistry. The disadvantage of this type of crosslinking chemistry is that the cure requirements exceed the heat distortion temperatures of most plastics.

3. A new type of single package coating (pseudonym for a 1K coating) has been promoted (16) for having a superior balance of flexibility, hardness, UV durability, and environmental etch resistance. This carbamate chemistry cures in the same range as MF-based crosslinkers and has been shown to exhibit excellent shelf life and application properties.

4. The most-widely recognized crosslinker utilized in 2K coatings is an isocyanate resin (17). The isocyanate is capable of curing at ambient tempera-

tures, and as such can be utilized in aftermarket refinish paints. The low-temperature curing requirements for this type of crosslinking is also advantageous in the painting of OEM plastics in that unsupported parts can be cured without distortion. It has been demonstrated, that 2K isocyanate crosslinked systems exhibit superior environmental etch resistance, which is a significant advantage in horizontal painted plastic applications, such as hoods and deck lids. Impact/flexibility properties of 2K isocyanate-based coatings generally exceed those of MF crosslinked systems. The toxicity issue associated with isocyanate-based resins must be taken into account when applying this type of coating, with adequate precautions taken to prevent sensitization to the isocyanate. Isocyanate sensitization may manifest itself after prolonged exposure to the isocyanate compound or almost immediately, depending upon the degree of sensitization of the individual exposed. Reactions to over-exposure include skin irritation or emphysema-like symptoms.

5. Carbodiimide crosslinked systems are achieved through the reaction of carbodiimides with carboxylic acids (18) to form N-acylureas. Curing schedules in the range of 30 minutes at 85°C are recommended. Flexibility in the crosslinked system is usually achieved by imparting flexibility into the carboxylic acid resin.

6. Aziridine (ethylene imine) crosslinking has been utilized extensively in the coating of interior, low heat-distortion temperature plastics because of its capability to crosslink under ambient conditions. Aziridine reacts with acids to form 2-hydroxyamides, which can further rearrange to the acid salt of 2-aminoester. Polyfunctional aziridines are generally achieved through the Michael addition of 3 moles of aziridine with 1 mole of trimethylol propane triacrylate. Polyaziridines can be formulated in water but usually only as two-pack systems. The pH is adjusted on the order of 8.5 to 9 to control the reactivity ratio of aziridine/carboxylic acid versus the competitive reaction with water. A major problem associated with aziridine, however, is the monomer's high toxicity and carcinogenicity.

7. Silane incorporation into coatings is generally accomplished through functionalization of an acrylic monomer through which reaction takes place (19,20). Methoxy functionality on a silane acrylic resin is first hydrolyzed (to a silanol moiety) and then subsequently reacted with a melamine or acrylic polyol resin to form the crosslinked matrix. The silanol functionality can also self-condense. The melamine and/or acrylic polyol portions of the coating formulation must be kept separate from the methoxy functional silane to prevent hydrolysis and subsequent crosslinking from occurring prematurely, and as such, this system is classified as a 2K system. Because the system is hydrolytically unstable, the moisture content of the system, in the can and also during application, must be kept low. For this reason, some of these systems are kept under a nitrogen blanket. A small amount of catalytic moisture, however, must be pres-

ent during the curing process. Curing of these 2K systems generally requires heat in the range of 121°C. The coatings thus produced have excellent chemical resistance but generally must be balanced through the appropriate resin formulation to afford good low temperature flexibility and recoatability.

8. Acetoacetate functionality in a base resin allows the formulator to develop a 2K system, which can condense with amino functional resins to produce a crosslinked network (21).

One can classify the properties generally attained with 1K versus 2K coatings (Table 5). Although the resistance properties listed in the table are generalizations, any of the attributes of a specified coating can be made an exception through variations in formulation. As depicted in the table, however, 2K coatings generally exhibit better impact, weathering, and environmental etch resistance than their corresponding 1K counterparts. On the other hand, 1K coatings generally exhibit better abrasion and mar/scratch resistance than their 2K analogues. The choice of crosslinker is often offset by the type of binder used in the crosslinked coating system.

*Resins.* Most of the coatings for plastics formulated today utilize a flexibilized polyol resin system that generally fits into one of two categories: an acrylic or modified acrylic polyol or a condensation polymer (polyester, polyurethane, a combination of both through a physical blend, or modified resins that fall within the condensation polymer regime).

1. Acrylic polyols by themselves do not usually afford a good balance of properties when formulated into either a 1K or 2K coating. In order to provide flexibility, low glass transition ( $T_g$ ) acrylic polymers are generally utilized, but they do not possess adequate tensile strength to withstand the myriad of mechanical properties required to protect the substrate. By raising the  $T_g$  of the unmodified acrylic polyol the coating does increase in tensile strength, but the coating thus becomes too brittle to be utilized as a flexible coating. The balance of properties, tensile strength and flexibility, is most often achieved through either physically blending a hard acrylic polyol with a soft polymer, for exam-

**TABLE 5** Generic Performance of Flexible Coatings

| Paint type          | Resistance property |           |       |             |        |          |
|---------------------|---------------------|-----------|-------|-------------|--------|----------|
|                     | Weathering          | Acid etch | Gouge | Mar/scratch | Impact | Abrasion |
| 1K                  | -                   | -         | -     | +           | -      | +        |
| 2K PUR <sup>a</sup> | +                   | +         | +     | -           | +      | -        |

<sup>a</sup>PUR = polyurethane



ple, a linear thermoplastic urethane, or by grafting a soft, low  $T_g$  segment onto the hard, high  $T_g$  acrylic resin. The former approach, that of blending two dissimilar resins, often results in more problems than one began with, in that phase separation or polymer incompatibility can lead to poor coating performance. By far, the majority of flexible coatings for plastics are formulated with copolymers of hard and soft resins. Polycaprolactone is widely recognized as a flexibilizing agent for acrylic copolymers (22–24). In these examples, a relatively high  $T_g$ , hard acrylic polyol backbone resin is modified with the relatively low  $T_g$  polycaprolactone side chain to afford a good balance of flexibility and hardness. Side chains other than polycaprolactone have been utilized to modify the hardness/flexibility of acrylic resins. Simms (25–27) grafted acrylic resins onto polyester-urethane backbones through the use of vinyl benzyl chloride or a vinyl functional methoxy silane. In all cases, when formulated into 1K or 2K coatings, the systems exhibited excellent flexibility and UV durability.

Soft acrylic side chains have been grafted onto hard acrylic backbones through the use of mercaptoethanol (28,29) and a diisocyanate. The mercaptoisocyanate was then reacted with a hydroxyethyl methacrylate functional, high  $T_g$  acrylic to afford a mercapto functional side chain. This mercapto-modified acrylic copolymer was then grafted to a low  $T_g$  acrylic to afford an acrylic copolymer with essentially two different  $T_g$ s. Crosslinking this resin with either MF or polyisocyanate resins produced coatings with excellent tensile strength and good elongation.

2. Condensation polymers, for example, polyesters, polyurethanes, etc., generally afford flexible coatings with good durability when crosslinked with the appropriate MF or isocyanate-based resin. The amount of branching, which controls to some extent the crosslink density, the molecular weight of the resin, which controls for the most part the VOC attainable, and the  $T_g$  of the resin must be balanced to attain the best performance. Although polyesters alone have been shown to afford flexible, durable coatings when crosslinked with MF resins (30), it was determined imperative to control the amount of branching in the polyester as well as the weight average molecular weight. It was shown that urethane-modified polyesters, in general, provided similar coating properties when crosslinked with MF resins (31). The requirements of the resin deemed important in achieving the best balance of properties were a low  $T_g$  polyol ( $T_g < 25^\circ\text{C}$ ), a short chain diol or diamine, minimal branching in the polymer, and a polyisocyanate. The molecular weight of the soft polyol segment should be high enough to provide phase separation of the smaller urethane segments within it.

Water-based analogues to the above-mentioned polyester-urethane have been synthesized and are shown to possess adequate properties to be formulated into flexible coatings for plastics (32). The polymer is rendered water dispersible through the use of dimethylolpropionic acid, which provides carboxyl groups for neutralization with amine.

*Reactive Diluents.* Another consideration in formulating flexible, low-VOC coatings, involves the choice of reactive diluent, a low-viscosity co-reactant designed to lower the VOC of the coating system. While they reduce the viscosity of the polymeric constituents (similar to solvents), they also undergo reaction with the crosslinker utilized in the system. The ideal reactive diluent should possess the following traits: (1) low intrinsic viscosity, (2) good solubility/solvency, (3) relatively high equivalent weight, (4) reasonable pot life (in 2K formulations)/good cure response, and (5) good film performance/weathering.

There are a variety of reactive diluent compounds available today, including diols/polyols, hindered amines, aldimines, ketimines, and oxazolidines. Amino compounds, in general, are not suitable for use as reactive diluents in 2K systems, unless applied using plural component equipment, because of their very fast reaction with isocyanates to form ureas.

The reactive diluents, ranging in solids levels from approximately 60% to as high as 100%, are generally added to the coating formulation at levels of 10% to 30% by weight, most often replacing the resin binder. The amount of added reactive diluent is determined by the viscosity reduction required. It is imperative that the reactive diluent not interfere with the necessary rheological characteristics of the system, while still maintaining the flexibility and hardness required in the cured system.

### 3.3 Coating Formulations

In a coating formulation, the resin (often referred to as the binder), as previously described, imparts the main attributes to the coating when cured (crosslinked) with the crosslinking agent (crosslinker). The curing, or network formation, is often accelerated through the use of a catalyst, for example, acid catalysts in the MF crosslinking reaction and tin complexes, for example, dibutyl tin dilaurate, in the isocyanate crosslinking reaction. Rheology control agents, often referred to as sag control agents, are added to the formulation to impart shear thinning characteristics when under high shear (e.g., spray application) and rheology or antisagging behavior when under low shear (e.g., after application on a substrate). Pigments are introduced to impart color, gloss control, and/or UV protection.

The amount of pigment utilized depends upon the color and the hiding power required of the coating. The flow and leveling additive is often introduced to relieve surface tension variations between the coating and the substrate, or to eliminate craters or pinhole formation. Solvents are added as necessary to achieve flow under the application conditions, for example, spray, dip, etc. When coating plastics, it is of particular importance to choose solvents that will not degrade or craze the solvent-sensitive types, for example, PC, polystyrene, ABS. Stress crazing due to solvent attack can dramatically lower the physical properties of the coated part, for example, impact resistance, adhesion, etc.

In order to achieve a VOC-compliant coating, one must consider the molecular weight of the main binder utilized in the coating formulation, as well as the effect of additives on the final paint viscosity. After all, application viscosity, which in turn is affected by the rheology of the coating constituents, is most often controlled by freely adding solvent to achieve the necessary flow and leveling on the part. Addition of the solvent affects the final VOC emission of the paint.

### 3.3.1 Primers

In difficult to paint substrates, such as thermoplastic polyolefins, the adhesion promoting primer (often referred to as an adhesion promoter) is the foundation of subsequent paint adhesion. Excluding such difficult-to-paint materials, one has the option of next applying a primer/surfacer. The primer/surfacer can be utilized for a variety of reasons, including increased resistance to topcoat/solvent strike-in, attainment of conductivity, improved chip resistance, or color-keyed assimilation to the subsequent basecoat application. In this case, the color-keyed primer approximates an 80 to 90% color match to the topcoat that is to be applied. This allows the finisher to utilize less of the topcoat (basecoat) that is often the most expensive part of the paint process.

The primer/surfacer, composed most often of a polyester crosslinked with a blocked isocyanate or MF resin, is generally applied at a dry film thickness of approximately 25 microns (1.0 ml) by conventional spray application equipment. The primer is often made conductive through the incorporation of conductive pigments such as carbon black, to increase the transfer efficiency of the electrostatic topcoating process.

The cure requirements of most primers fall within the range of 121°C to 160°C for 20 minutes, and are predicated on the crosslinker. It is imperative, as always, to match the cure requirements of the primer with the heat-distortion temperature of the plastic. As a general rule, the primer cure temperature should be selected so as to cure at 10°C or lower than the heat distortion temperature of the plastic that is being coated.

### 3.3.2 Basecoats

Solvent-based basecoats, consisting of polyester, modified polyurethane-polyesters, or caprolactone-modified acrylic polyols, are subsequently crosslinked with MF resins or polyisocyanates. The films are applied at dry film thicknesses of approximately 13 microns up to 45 microns, depending upon the hiding power of the color. The hiding power is defined as the lowest film thickness that hides a black-and-white or gray-and-white hiding chart. The hiding power is predicated on color due to the composition of pigments utilized to make up the color. For example, if the color is composed of a majority of transparent iron oxides, (e.g., red basecoat straight shade) the film thickness requirement will be higher

than that of a black basecoat, which contains carbon black with excellent opacity. Poor hiding colors, such as red, yellow, and white straight shades, require higher film build to achieve hiding than metallics and darker shade colors.

Newer special-effect pigments, such as coated micas and sputtered or dielectrically deposited pigment-layered composite pigments, have allowed color stylists to develop more innovative colors that are richer, afford high chromaticity, and display sharper hues.

Solvent-based basecoats are generally applied and allowed to flash off (synonymous with solvent evaporation) at room temperature, or at a slightly elevated temperature, for three to five minutes before the clearcoat is applied. This process of applying one coating over another, where the first coating is not in a crosslinked or cured state, is referred to as the “wet-on-wet” process.

Optionally, a water-based basecoat can be utilized to achieve better aluminum orientation in metallic films. Several researchers (33,34) have ascribed better parallel alignment of the metallic flakes within the basecoat to better metallic orientation. This orientation is believed to occur as a result of the greater degree of shrinkage in water-based coatings, due to the lower solids content (typically on the order of 30% by weight) of water-based coatings than comparable high-solids basecoats (solids levels typically on the order of 40 to 50% by weight).

The water-based basecoat consists of a urethane or an acrylic dispersion that may or may not be crosslinked. Crosslinkers generally consist of blocked isocyanates or MF resins. The basecoat is spray applied and prebaked (with infrared, microwave, or thermal convection ovens) in what is generally referred to as a “heated flash” to remove a majority of the water (>90%) prior to clearcoat application.

### 3.3.3 Clearcoats

The solventborne clearcoat is spray applied over the basecoat at a dry film thickness of 1.8 to 2.0 mils. The clearcoat, responsible for UV protection, chemical resistance, chip resistance, and so on, is most often composed of a hydroxy functional acrylic binder together with a melamine or isocyanate crosslinker. Ultraviolet light absorbers and hindered amine light stabilizers are added to achieve better free-radical oxidative degradation resistance that results from exposure to sunlight.

The clearcoat is referred to as a 2K clearcoat when an isocyanate crosslinking agent is utilized as the crosslinker. The isocyanate must be added to the hydroxy functional acrylic just prior to spray application to prevent premature gellation (crosslinking). For this reason, the two-part mixing is referred to as 2K. Cure conditions for isocyanate crosslinked systems range from ambient (car refinish technology) to 250°F for 30 minutes.

The 1K clearcoats are equivalent to 2K clearcoats with the exception that they are crosslinked with melamines. Cure conditions can be lowered to as much

as 230°F through the addition of acid catalysts but generally lie in the range of 250°F for 30 minutes. Blocked isocyanate crosslinked versions of 1K clearcoats are also available, but cure requirements necessitate 275°F or higher to deblock the isocyanate and allow it to react. Typically, blocking agents on the isocyanate include methyl ethyl ketoxime and malonate esters.

Significant research is being conducted on waterborne clearcoats in attempts to achieve lowered VOC emissions. Waterborne clearcoat research is limited to water-dispersible acrylics because high gloss and good weatherability can be attained. Removal of water from the film, however, is problematic as coalescence often begins prior to through-cure, resulting in “solvent popping.” Much work remains to be performed on optimum formulation parameters (i.e., solvent blend, anticratering surfactants, rheology control, etc.) in order to attain defect-free coatings.

### 3.3.4 New Crosslinking Technologies

The traditional crosslinking technologies utilized in the coatings market range from hydroxyl functional binders—acrylics or poly(estere)s—crosslinked with melamines (1K) or isocyanates (2K) to drying oils that cure through oxidation of the unsaturated bonds, to epoxy resins crosslinked with amino resins (amido amines, amines, etc.).

New crosslinking technologies, however, are being developed with hopes of achieving more environmentally acceptable coatings. Fluoropolymers, epoxy-anhydride new curing technology (NCT), and siliconized-acrylics new enamel technology (NET) are a few of the coating chemistries being introduced. Increasing demands have necessitated these advances. The need for properties such as chip resistance and resistance to “acid rain” may result in further technological advances in the future.

### 3.3.5 “Nonpolluting” Coatings

If we look at the molecular weight dependency of resins utilized in the various coating types, it is readily evident why VOC compliance is more easily achieved in radiation-curable and powder coatings. The molecular weight of nonaqueous dispersion resins, for example, exceeding  $10^5$  g/mole, results in very viscous materials, whereas the typical molecular weight of a radiation cure oligomer ranges from  $10^2$  to  $10^3$  g/mole. The radiation cure oligomer is a very low-viscosity material that requires little if any additional solvent to attain application specifications.

Considering the evolution of coating technology over the last 70 years, it is evident that by the mid-1950s waterborne and higher solids coatings were already under development. Powder coatings, 100% reactive liquid coatings (electron beam and UV cure), and other novel “nonpolluting” coatings (i.e., supercritical carbon dioxide) weren’t necessarily in vogue until later in the decade.

*Powder Coatings.* There are several types of powder coatings available, classified by resin type and crosslinker (35). The major impetus for growth can be attributed to the virtual "pollution-free" finishing system as well as the dramatic leap forward in materials and equipment technology that makes them essentially 100% transfer efficient (with recycling spent powder). Major powder coating research and development goals for the future include (1) reducing baking temperature, (2) improving thin-film capability, and (3) providing low-gloss exterior durable systems.

Thermosetting powder coatings tend to begin crosslinking at or near their melt temperature. This can severely limit the smoothness capability of a deposited coating. Cure temperatures of these thermosets generally lie in the range of 300°F to 350°F. As such, these coatings can only be applied and cured over thermoset plastics, such as SMC, that have a higher heat distortion temperature than that required for the powder to crosslink. Applications for these high curing-temperature powders have included chip-resistant primers as well as in-mold primers.

Several vinyl ether functional poly(urethane) powder coatings have been formulated that show a sharp melt temperature at 40°C or 60°C and no crosslinking until 120°C. This wide gap between the melt and crosslinking temperature allows better flow and leveling prior to full cure. The crosslinking temperature is effectively lowered through the use of a latent cationic initiator that decomposes just prior to crosslinking (36). The lowered cure requirements of these powders allow one to use them on a wider variety of plastic components.

Witzeman (37) studied the effect of resin and crosslinker types on the cure behavior of polyester resins cured with blocked isocyanates. It was found that cure temperatures as low as 129°C to 140°C could be achieved with blocked isocyanates based on the oximes of diisobutyl ketone and diisopropyl ketone. The polyester resin utilized contained sterically unencumbered hydroxyl groups to allow unique flow properties at the low curing temperatures.

Flame spraying has been utilized as a technique to increase the flowability of thermoplastic powder coatings. By passing the powder through an air/gas (usually propane) flame, the powder is efficiently melted into a free-flowing composition before impact onto the substrate. Once reaching the substrate, the powder can flow and be subsequently quenched to prevent further degradation of the resin. By quenching the powder, varying degrees of crystallinity can be attained that can afford dramatically different physical properties of the cured coating, that is, impact resistance, elongation, etc.

Special-effect powders can be achieved through the blending of different materials and using different application techniques (38). Powder effects can range from translucents, wrinkles and veins, and multiple colors, to chameleon finishes that appear to change color. Through the use of controlled incompatibil-

ity, utilizing varying melt and flow-rate powders, wrinkle finishes can be achieved. By utilizing mica pigmentation the chameleon and special-effect translucent powders are attained. The “spatter” or “splatter” finish is attained through the use of two coats of powder, each of which has a degree of incompatibility with the other.

*Ultraviolet/Electron Beam.* Radiation-curable (Radcure) coatings were developed by W. J. Burlant of the Ford Motor Company in 1962. Radcure technology describes the use of UV radiation or an energetic electron beam (EB) to cure or harden the coating. Radiation with energy of about 1.7 to 6 electron volts (EV) (representing the UV region) and about 10,000 to 1 million EV (the EB range) are the industrially important portions of the electromagnetic energy spectrum (39).

The major advantages of Radcure technology are speed of cure, reduced emissions, 100% solids systems, and elimination of ovens or other sources of thermal energy (less energy consumption). However, there are also disadvantages: UV coatings are generally toxic because of the chemical nature of the monomers that comprise the coating; and uniform, flat substrates are generally necessary for the “line-of-sight” UV radiation.

The UV coating is comprised of unsaturated monomers that polymerize with UV light (in the presence of a photoinitiator, which absorbs radiation and begins polymerization). Urethane acrylates are generally known for their flexibility, whereas aromatic epoxide acrylates give hard and brittle coatings. Factors affecting the mechanical properties are the elastically effective chain length between monomers and the  $T_g$  of the crosslinked resin. Generally, the higher the crosslink density, for example, the lower the elastically effective chain length, the harder the film, whereas flexibility is best attained with noncrosslinked systems (40).

New photoinitiators that provide for strong absorption at longer wavelengths are allowing formulators to incorporate more pigmentation into their coatings. Curing white pigmented coatings, for example, which had been a difficult task due to the strong pigment absorption in the longer UV region, is now accomplished with advanced photoinitiator blends of substituted phosphine oxides and phenyl ketones.

*Supercritical CO<sub>2</sub>.* Union Carbide patented the novel use of “supercritical” carbon dioxide paint application as a means to effectively lower the VOCs of coatings. In this process, supercritical carbon dioxide, at conditions above critical temperature and pressure in the phase diagram (for CO<sub>2</sub> the critical point is 72.8 atm and 31.1°C) acts as a liquid, and is utilized as a solvent enabling a coating to be applied at increased solids and reduced VOCs. Coating composition can remain essentially the same. Advantages of this technology include VOC emission reductions (up to 80% of the solvent can be removed), increased

atomization of paint, and simplified formulating practices. Disadvantages associated with the technology include the need for carefully controlled temperature/pressure application equipment.

The decompressive release of supercritical carbon dioxide during spray application produces a new type of spray that can have superior atomization characteristics compared to conventional air-less and air-assisted application methods (41). Supercritical carbon dioxide has good solvent properties in a variety of polymers. Solubility of the polymer is influenced by polymer molecular weight, polydispersity, solubility parameter, functionality, and structure (42). Significantly increased solubility has been demonstrated by including fluorine, silicon, and bulky substituent groups in the polymer structure.

Commercial successes in the painting of plastic components with supercritical carbon dioxide applications have been demonstrated (43): flexible urethane clearcoats have been applied at significantly higher film builds with higher quality appearance and improvements in acid etch resistance; flexible acrylic clearcoats were applied at 50% higher solids levels, with higher film builds, better chemical and etch resistance, and better durability being achieved; and an adhesion promoter for TPO was applied through supercritical carbon dioxide application with a subsequent increase in transfer efficiency, without using electrostatics, of 10%. Coating coverage was smoother while coating coverage was increased fourfold; and a polyester primer for SMC with increased transfer efficiency and increased film build was applied.

*Film Laminates.* Using Dry Paint Film laminate technology, molders and extruders of plastic parts can apply either a prime or basecoat/clearcoat paint finish to parts without using secondary VOC-generating spray operations (44). Unlike mold-in-color and in-mold coating systems, dry paint film gives molders the ability to achieve body match capability.

Dry Paint Film laminate is a composite of a continuous cast polyvinylidene difluoride (PVDF) coating that is air dried and laminated to an extruded gel-free thermoplastic backing sheet. The thickness of the thermoplastic sheet varies by application process and is generally composed of either TPO or ABS.

Three application processes exist for adhering the Dry Paint Film to the part: (1) insert molding, (2) in-mold molding, and (3) extrusion lamination. Choosing the right process is primarily a function of part geometry and what elongation the film must endure to cover the part.

*In-Mold Coatings.* Powder in-mold coatings have successfully replaced gel coats as primers to virtually eliminate substrate porosity (45). The coatings are composed of an unsaturated polyester resin, a copolymerizable crosslinking resin, colorants, additives, and an initiator. The combination of resin accelerators and initiators is chosen to give adequate film strength during molding, good surface smoothness, and hardness. The coating ingredients are melt mixed well



below their reaction temperatures yielding a homogeneous mixture that is ground to a finely divided powder.

Application of the powder to the hot mold surface is usually accomplished robotically. It is important that double passes over already coated mold surfaces are minimized. Film builds greater than 12 to 15 mils can lead to tearing of the coating during the molding operation or cracking during the cure cycle. Cure is accomplished for one to three minutes at 275°F to 325° F. Because the in-mold coating does impede flow of the SMC during compression, high-flow, low-shrink SMC is used. The coated SMC exhibits excellent scratch and heat resistance as well as eliminated substrate porosity.

## 4 RECYCLING CRITERIA

### 4.1 Plastic Recycling Mandates

About 95% of all automobiles are recycled; however, recycling is generally limited to the 75% by weight of the vehicle that is metallic. The remaining 25%, including a significant amount of plastics, have been difficult to recycle cost effectively (46). As a result, most of that remaining material, known as automotive shredder residue (ASR), is disposed of in landfills.

The European Parliament has ratified a directive for processing end-of-life vehicles (ELV) that affects primarily automakers, dismantlers, and material recyclers. The aim of the ELV directive is to increase the rate of recovery and recycling of vehicle components. Automakers will be expected to meet all or a significant part of the “take-back” costs of ELVs. The directive mandates a rate of recovery of 85% by weight by 2006 (of which 80% is recycled), which will rise in 2015 to a recovery of 95% by weight (of which 85% is recycled). For vehicles sold after January 1, 2001, automakers are immediately responsible for the costs of take-backs. For vehicles sold prior to 2001, automakers will have to pay for take-back until January 2007.

The ELV directive places the take-back burden, disposal prohibitions, and landfill avoidance on the OEM. In establishing plastics recycling processes, an automaker must develop not only dismantling procedures, but also an accurate number of suitable applications utilizing the materials recycled. The plastics recycled must offer a suitable price/benefit ratio versus the virgin plastic material, typically 30% to 50% below the cost of virgin (47). A cost comparison of recycled automotive plastics and virgin plastics shows that the gap narrows only at the medium price level of automotive plastics.

As shown in Figure 3, only 35% of the overall costs associated with the recycling process result from recomounding while 65% of the cost is attributable to other procedures upstream, such as dismantling, sorting, and transportation.

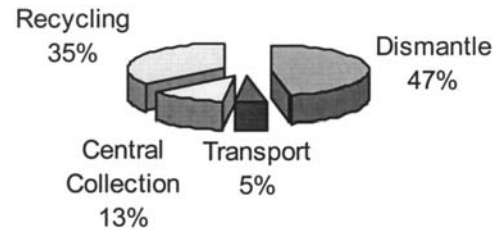

FIG. 3 Cost structure of recycled automotive plastics. (From Ref. 48, used with permission.)

#### 4.2 Design for Recyclability

The mix of new materials in a car can be dizzying—and a separation quandary for dismantlers. In addition, the popular use of adhesives for improved body stiffness and streamlined assembly means that subassemblies composed of a variety of materials are more difficult to separate than in the past. Designers must begin thinking about the whole-product life cycle, including material selection, serviceability, recyclability, and dismantlability. Included in the tips for recycling (49):

- Replace fasteners with snap-fits or compatible adhesives when practical.
- Minimize screw-head types and sizes for components in one area of the vehicle.
- When practical, use plastic fasteners of the same material as the substrate or attaching parts.
- Use ferrous metallic fasteners when practical for magnetic separation after component shredding.
- Design fasteners to be accessible.
- Design molded-in clips to be removable without breaking off.
- Avoid materials believed to pose health risks, such as cadmium.
- Choose known recycled materials.
- Use fewer material types.
- Consolidate parts.
- Avoid laminating dissimilar materials, foaming, painting, and cloth-covered trilaminate that can clog shredding equipment.
- When possible, design laminates from compatible materials.
- Design components to be easily dismantlable.
- Route electrical wiring to facilitate removal.
- Mark parts with standard polymer type symbols (Table 6).

**TABLE 6** American Plastics Council Recycling Codes

| Number designation | Material code | Material composition   |
|--------------------|---------------|--|
| 1                  | PETE          | Polyester  |
| 2                  | HDPE          | High-density poly(ethylene)                                      |
| 3                  | V             | Vinyl, PVC, PVB <sup>a</sup> , EVA <sup>b</sup>                  |
| 4                  | LDPE          | Low-density poly(ethylene)                                       |
| 5                  | PP            | Poly(propylene)  |
| 6                  | PS            | Poly(styrene)  |
| 7                  | O             | Other: mixed plastic, poly(carbonate), ABS, acrylic, nylon, etc. |

<sup>a</sup>PVB = polyvinyl butyral

<sup>b</sup>EVA = ethyl vinyl acetate

**4.3 Paint Removal**

Getting paint and other coatings off plastics has plagued auto recyclers. Paint and coatings, as previously described, contaminate recycle resins, causing a degradation in physical properties and/or appearance. Technologies such as compressed vibration and hydrolysis show promise, but can be prohibitively expensive (50). In Japan, Nissan Motor Company and Mitsui Petrochemical Industries, Ltd. Have jointly developed a process to strip the paint from used thermoplastic bumpers. Engineers shred the bumper, then soak them in a caustic soda solvent at high temperature. After it is rinsed, the material runs through a mechanical stripper. Finally it is pelletized and fed into the raw material stream for new bumpers (50).

The typical new car also leaves behind approximately 12 pounds of paint sludge at the factory (51). A typical auto plant has about 1,500 tons of paint sludge per year. The bulk of the sludge ends up in landfills. But National Recycled Plastics LLC has begun collecting, drying, and recycling leftover automotive paint. It then extrudes the paint into blocks that it is utilizing in railroad blocks and other markets.

**4.4 Molded-in-Color Segregation**

In efforts to eliminate paint and to increase the price competitiveness of molded parts, several automotive plastic manufacturers have opted to mold plastics in color. This process involves placing the colorant directly into the resin, either by precompounding or adding “color-at-the-press,” so that the fabricated part is the color of choice. End-of-life recycling of these parts, however can become troublesome because the mingling resulting from nonsegregation of scrap parts will only result in one color—black.

The plastic engineer has two choices in dealing with mold-in-color plastics: to segregate the parts so that all colors remain only within their color family, or to comingle the materials with varying colorants and find an application for a black or darkly colored resultant material. The choice is often the latter due to costs associated with material segregation.

In efforts to comingle materials, however, additives or varying resin balances in the mix result in poorly compatibilized resins. As discussed in the previous sections of this chapter, if paints, laminates, alloys, or functional additives in the plastic material are not compatible, then blooming, cohesive debonding, or degradation of the recycled plastic material properties are evidenced. Table 7 lists the compatibility of several thermoplastic resins. If plastics are deemed noncompatible or of limited compatibility, compatibilizing resins or additives may be added to the mix to achieve suitable properties (52). Table 7 lists the compatibility differences between several thermoplastics.

#### 4.5 Energy Conversion

Of the 220 or so pounds of plastics on the average car, large parts that are easy to dismount and mechanically recycle account for 22 to 44 pounds. The remainder is made up of around 1,500 components that are too small for dismantling but that have a high calorific value that makes them suitable for energy recycling (3). Because plastics are generally derived from petroleum or natural gas, they have stored energy values higher than any other material commonly found in municipal waste streams (53). The energy values of several common materials are given in Table 8 (54).

In the municipal solid waste streams in 1999, plastics amounted to about 10.5% by weight of the 459.8 billion pounds of municipal solid waste (55). The waste plastic collected from the solid waste stream is a contaminated, assorted mixture of a variety of plastics. This makes their identification, separation, and purification very challenging. In the plastic waste stream, polyethylene forms the largest fraction, which is followed by PET.

Any attempt to manage such large quantities of a diverse, contaminated mixture of plastic in an energy efficient and environmentally benign manner needs to be considered using an integrated approach. This requires that the various steps in the life of plastics be considered, such as the raw materials for their manufacture, reuse, recycling, landfill, or waste-to-energy conversion.

Plastic recycling, as discussed in the previous section of this chapter, has grown appreciably over the last few years. Recycling through the generation of monomers and building blocks in high purity from plastic waste, such as carpet, is underway. Such novel recycling (e.g., glycolysis, pyrolysis, ammonolysis, etc.) represents a significant technological advancement that could supplement existing mechanical recycling techniques.

TABLE 7 Compatibility of Thermoplastics

|                                     | ABS | ASA | PA | PBT | PC | PBT/PC | PC/ABS | PC/PBT | PE | PET | PMMA | POM | PP | PPO | PS | PPO/PS | PS | PVC | SAN | TPU |
|-------------------------------------|-----|-----|----|-----|----|--------|--------|--------|----|-----|------|-----|----|-----|----|--------|----|-----|-----|-----|
| ABS-acrylonitrile-butadiene-styrene | G   | G   | L  | G   | G  | G      | G      | G      | L  | L   | G    | L   | L  | L   | L  | L      | L  | L   | G   | G   |
| ASA-acrylonitrile-styrene-acrylate  | G   | G   | L  | G   | G  | G      | G      | G      | L  | L   | G    | L   | L  | L   | L  | L      | L  | L   | G   | G   |
| PA-polyamide                        | L   | L   | G  | L   | L  | L      | L      | L      | L  | L   | L    | L   | L  | L   | L  | L      | L  | L   | L   | L   |
| PBT-polybutylene terephthalate      | G   | G   | L  | G   | G  | G      | G      | G      | L  | L   | L    | L   | L  | L   | L  | L      | L  | L   | L   | L   |
| PBT/PC-PBT polycarbonate            | G   | G   | L  | G   | G  | G      | G      | G      | L  | L   | L    | L   | L  | L   | L  | L      | L  | L   | L   | L   |
| PC                                  | G   | G   | L  | G   | G  | G      | G      | G      | L  | L   | L    | L   | L  | L   | L  | L      | L  | L   | L   | L   |
| PC/ABS                              | G   | G   | L  | G   | G  | G      | G      | G      | L  | L   | L    | L   | L  | L   | L  | L      | L  | L   | L   | L   |
| PC/PBT                              | G   | G   | L  | G   | G  | G      | G      | G      | L  | L   | L    | L   | L  | L   | L  | L      | L  | L   | L   | L   |
| PE-polyethylene                     | I   | I   | L  | I   | L  | I      | L      | I      | G  | I   | I    | I   | G  | I   | L  | L      | L  | L   | I   | L   |
| PET-polyethylene terephthalate      | G   | G   | L  | G   | G  | G      | G      | G      | L  | L   | L    | L   | L  | L   | L  | L      | L  | L   | L   | L   |
| PMMA-polyethyl methacrylate         | G   | G   | L  | L   | L  | L      | L      | L      | L  | L   | L    | L   | L  | L   | L  | L      | L  | L   | L   | L   |
| POM-polyoxymethylene (acetal)       | L   | L   | L  | L   | L  | L      | L      | L      | L  | L   | L    | L   | L  | L   | L  | L      | L  | L   | L   | L   |
| PP-polypropylene                    | I   | I   | L  | I   | L  | I      | L      | I      | L  | L   | L    | L   | L  | L   | L  | L      | L  | L   | L   | L   |
| PPO-polyphenylene oxide             | L   | L   | L  | L   | L  | L      | L      | L      | L  | L   | L    | L   | L  | L   | L  | L      | L  | L   | L   | L   |
| PPO/PS-PPO/polystyrene              | L   | L   | L  | L   | L  | L      | L      | L      | L  | L   | L    | L   | L  | L   | L  | L      | L  | L   | L   | L   |
| PS                                  | L   | L   | L  | L   | L  | L      | L      | L      | L  | L   | L    | L   | L  | L   | L  | L      | L  | L   | L   | L   |
| PVC-polyvinyl chloride              | G   | G   | L  | L   | L  | L      | L      | L      | L  | L   | L    | L   | L  | L   | L  | L      | L  | L   | L   | L   |
| SAN-styrene acrylonitrile           | G   | G   | L  | L   | L  | L      | L      | L      | L  | L   | L    | L   | L  | L   | L  | L      | L  | L   | L   | L   |
| TPU-thermoplastic urethane          | G   | G   | L  | L   | L  | L      | L      | L      | L  | L   | L    | L   | L  | L   | L  | L      | L  | L   | L   | L   |

G = good compatibility over wide composition range; L = limited compatibility with small quantities; I = incompatible.

**TABLE 8** Energy Values of Common Materials

| Material        | BTU/pound |
|-----------------|-----------|
| <i>Plastics</i> |           |
| Polyethylene    | 19,900    |
| Polypropylene   | 19,850    |
| Polystyrene     | 17,800    |
| Rubber          | 17,800    |
| Newspaper       | 8,000     |
| Leather         | 7,200     |
| Wood            | 6,700     |
| Yard waste      | 4,500     |
| Food wastes     | 2,600     |
| Fuel oil        | 209,000   |
| Wyoming coal    | 9,600     |

Source: Ref. 55.

Another important way to manage solid waste is to recover the energy value of products after their useful life. One such method involves combustion of municipal solid waste or garbage in waste-to-energy facilities. The facilities burn solid waste in special combustion chambers, and use the resulting heat energy to generate steam and electricity. As shown in Table 8, polyolefins commonly used in packaging can generate twice as much energy as Wyoming coal and almost as much energy as fuel oil.

#### 4.6 Odor

During the processing of recycled plastics and the use of plastic products, undesired odor emissions can occur. Wide ranges of methods are known for the classical case of odor reduction of plastics. For the regeneration of PP from used battery casings special additives are processed with the PP to overlay the odor emissions (56). During the processing of polyurethane foam for automotive applications the odor of the polymer can be reduced by adding an isocyanate modified amine catalyst (57). In the case of ethylene polymers, adding epoxides during processing can significantly reduce the odor emissions (58).

The odor reduction in recycled plastics is of special interest because these materials are contaminated with odorous substances, for example, paint, process stabilizers, etc. Recently used methods to reduce odor involve:

- The multiple degasification during extrusion,
- The extraction of material with a solvent to remove contamination, and

- The application of filler materials with high specific surface to adsorb odorous substances.

In the United States, all projects regarding the recycle of plastics from ASR was halted in April of 2000 when the U.S. EPA reopened its 22-year-old polychlorinated biphenyl (PCB) regulations (59). PCBs were once used primarily as flame retardants in transformer oils. EPA outlawed almost all uses of PCBs in the mid-1970s, after they were determined to cause cancer. After extracting, washing, and rinsing plastics from the ASR, the plastics have PCB content of 5 to 10 parts per million (ppm)—within the government's 50 ppm guideline.

The issue of phthalate plasticizer migration, PVC emissions, and the like are issues remaining on the table to be resolved. In addition to potential odor and toxicity concerns, plastic recyclers must assure that the plastics recycled maintain the desired use properties. As more automotive OEMs require mandated levels of postconsumer and postindustrial recycle, these issues will be resolved.

## 5 FUTURE TRENDS

While metal still rules the road in production vehicles, designers' concept cars also look to carbon fiber, aramid fiber, natural fiber, and a range of composite technology for body panels and structural components. On the inside, there are thermoplastic elastomers, and urethane to provide soft-touch feel while plastic-laminated glass provides a tinted view of the world.

The biggest holdup in bringing all plastic body components to the forefront of the industry remains finding an affordable, aesthetically attractive replacement for painting. While film laminate technology and mold-in-color ionomers have been researched, the cost and capital implications of instituting these technologies remains unresolved.

The implementation of fuel-cell vehicles may drive plastics to a new arena. There is still a need for lightweight, aerodynamic body systems in order to achieve desired fuel efficiency. Plastics will find new niches, especially in lieu of the new "nano-particle" filled materials. Lighter weight, thinner wall stock, and higher modulus materials can be enacted while maintaining the low-temperature impact resistance that had been problematic with traditional filled materials.

The industry's eye on "green" and environmentally friendly vehicles will drive the use of recycle. How to recycle the myriad of plastic types utilized into cost-efficient materials that meet required specifications remains problematic. Compatibilizer research, for example, the ability to compatibilize dissimilar plastics for end-use applications, will continue to proliferate. Cost-conscious engineers will continue to mandate low-cost materials, especially polyolefins.

## REFERENCES

1. B Siuru. *Mechanical Engineering*, November 1990, p. 66.
2. H Hock and MA Maten. SAE Paper #930561, 1993.
3. P Mapleston. *Modern Plastics*, May 1995, p. 48.
4. C Chasmawala. *Proceedings of ANTEC 2000*, 2000, p. 3569.
5. V Wigotsky. *Plastics Engineering*, September 1997, p. 27.
6. R Miel. *Plastics News*, October 15, 2001, p. 1.
7. V Wigotsky. *Plastics Engineering*, September 2000, p. 27.
8. *Design News*, September 20, 1999, p. 105.
9. R Sawyer. *Paint and Coatings Industry*, September 1990, p. 25.
10. S Schulte. *Products Finishing*, June 1990, p. 28.
11. *Paint and Coatings Industry*, April 1988, p. 25.
12. LF Savelli. *Paint and Coatings Industry*, April 1996, p. 40.
13. WH Tyger, RF Cornuet, Jr., and BK Johnston. U.S. Patent 5,106,651, 1992.
14. DH Solomon. *Organic Chemistry of Film Formers*. New York: Robert E. Krieger Publishing Co., 1982.
15. RT Wojcik, JM O'Connor, HG Barnowski, Jr., MJ Morgan, FA Stuber, RS Blackwell, GH Temme, and RR Wells. *Proceedings of the Waterborne, Higher-Solids, and Powder Coating Symposium*, New Orleans, LA, 1994, p. 474.
16. I Azuma, N Kosaka, and G Iwamura. *Proceedings of the International Conference on Organic Coatings: Science and Technology*, Athens, Greece, 1996, p. 29.
17. JD Nordstrom. *Proceedings of the Waterborne, Higher-Solids, and Powder Coating Symposium*, New Orleans, LA, 1995, p. 492.
18. PJA Geuink and L van Dalen. *Proceedings of the International Conference on Organic Coatings: Science and Technology*, Athens, Greece, 1994, p. 161.
19. RA Etzell, BJ Miller, and DJ Dziekan. U.S. Patent 4,546,046, 1985.
20. RA Etzell, BJ Miller, and DJ Dziekan. U.S. Patent 4,720,528, 1985.
21. RA Etzell, BJ Miller, and DJ Dziekan. Canadian Patent 1,246,769, 1988.
22. RA Ryntz. U.S. Patent 4,873,285, 1989.
23. RA Ryntz. U.S. Patent 4,870,140, 1989.
24. RA Ryntz. U.S. Patent 4,810,759, 1989.
25. JA Simms. U.S. Patent 4,243,573, 1981.
26. JA Simms. U.S. Patent 4,206,108, 1980.
27. RM Piccirilli, WH Chang, DT McKeough, and S Porter. U.S. Patent 4,205,115, 1980.
28. WH Chang and ME Hartman. U.S. Patent 3,912,790, 1975.
29. RL Scriven and WH Chang. U.S. Patent 4,066,591, 1978.
30. SL Bassner and T Johnson. *Paint and Coatings Industry*, April 1996, p. 48.
31. DA Wicks. *Proceedings of the Twentieth Waterborne, Higher-Solids, and Powder Coating Symposium*, 1993, p. 49.
32. ZW Wicks, Jr., FN Jones, and SP Pappas. *Organic Coatings Science and Technology, Volume II: Applications, Properties, and Performance*. New York: John Wiley and Sons, Inc., 1994, chs. 19 and 20.
33. R Maisch, O Stahlecker, and M Kieser. *20th International Conference in Organic Coatings Science and Technology*, July 1994, p. 311.



34. DP Chapman. Proceedings of the 23rd High-Solids, Waterborne, and Powder Coatings Symposium, New Orleans, LA, 1996, p. 421.
35. GJ Bocchi. Modern Paint and Coatings, November 1989, p. 36.
36. JG Hillborn, P Magnus, SE Jonnson, E Stodeman, and SG Skolling. Proceedings of the 18th High-Solids, Waterborne, and Powder Coatings Symposium, New Orleans, LA, 1991, p. 321.
37. JS Witzeman. 20th International Conference in Organic Coatings Science and Technology, July 1994, p. 533.
38. T Triplett. Industrial Paint and Powder, May 1996, p. 10.
39. W Burlant, Industrial Finishing, May 1992, p. 16.
40. R Schwalm, L Haussling, W Reich, E Beck, P Enenkel, and K Menzel. 22nd International Conference in Organic Coatings Science and Technology, July 1996, p. 325.
41. KA Nielsen, JN Argyropoulos, DC Busby, DJ Dickson, CW Glancy, AC Kuo, and C Lee. Proceedings of the 20th High-Solids, Waterborne, and Powder Coatings Symposium, New Orleans, LA, 1993, p. 173.
42. JN Argyropoulos, KA Nielsen, DC Busby, and JJ Lear. Proceedings of the 21st High-Solids, Waterborne, and Powder Coatings Symposium, New Orleans, LA, 1994, p. 765.
43. KA Nielsen, JN Argyropoulos, DC Busby, DJ Dickson, and CS Lee. Proceedings of the 21st High-Solids, Waterborne, and Powder Coatings Symposium, New Orleans, LA, 1995, p. 151.
44. C Nastas. Proceedings of the Advanced Coatings Technology Conference, Dearborn, MI, November 1994, p. 87.
45. AT Daly and GD Correll. Proceedings of the Advanced Coatings Technology Conference, Dearborn, MI, November 1993, p. 99.
46. JL Broge. Automotive Engineering International, May 2001, p. 79.
47. J Doba. Plastics News, April 3, 2000, p. 30.
48. K Graser. Automotive Engineering, May 1996, p. 121.
49. A Baker. Design News, October 10, 1994, p. 137.
50. J Preiss. U.S. Patent 5,566,889, 1996.
51. R Miel. Plastics News, February 5, 2001, p. 25.
52. CF Balazs, et al., Michigan Molecular Institute Report: Advances in Automotive Plastics Recycling, Midland MI, 2000.
53. F Boettcher. Environmental Compatibility of Polymers in Emerging Technologies. In: PM Subramanian and GD Andrews, eds. Plastics Recycling. Washington, DC: American Chemical Society, 1992, pp. 16–25.
54. PM Subramanian. Resources, Conservation, and Recycling, 28:253–263, 2000.
55. Plastics News, December 3, 2001, p. 3.
56. H. Guyot. Recyclage du Polyporpylene a l'echelle industrielle, Plastiques Modernes et Elastomers, 43(6): 40, 1991.
57. World Patent WO9492525, 1993.
58. World Patent DE3838491.
59. J Doba. Plastic News, April 3, 2000, p. 30.



# 8

## Alternatives to Coatings for Automotive Plastics

### **Norm Kakarala**

Delphi Safety and Interior Systems, Troy, Michigan, U.S.A.

### **Thomas Pickett**

General Motors Corp., Warren, Michigan, U.S.A.

### **1 INTRODUCTION**

Coatings or paints are generally pigmented polymeric dispersions or powders that are usually applied as a secondary process step to form a surface layer on the substrate. Other chapters in this book are devoted to coatings. However, the focus of this chapter is to provide a comprehensive review of alternatives to coatings for automotive plastics. Alternative to coatings is defined as the methods that eliminate the need of applying a coating to automotive plastics. Why is there a chapter devoted to alternatives to coatings in a coatings book? Actually, it is quite beneficial to be aware of the “alternatives” to coatings and be able to assess the other opportunities that exist.

### **2 BACKGROUND**

Coatings are applied to plastics for a number of important reasons. Coatings provide desired appearance properties such as color, gloss, and harmony to the adjacent components that help sell the product. For example, in the early 1900s, coatings played an important role in allowing General Motors to outsell Ford to become the leading automobile manufacturer. General Motors offered different color automobiles compared to the black only Ford automobile. In addition to aesthetics, coatings are used on plastics to improve ultraviolet (UV) light stabil-

ity, improve scratch and mar resistance, and provide chemical resistance and harmony with adjacent components. Moreover, coatings can act as a permeation barrier. Depending on the application, coatings of plastics can be very important to the aesthetics and/or the functionality of the part.

With the numerous advantages that coatings offer, why do original equipment manufacturers (OEMs) have a strong desire to explore alternatives to coatings? Eliminating coatings can drastically reduce the cost of the part. No extensive investment for painting lines is required. Coating an injection molded part is 60 to 75 percent of the total part costs (1). There is an environmental advantage by eliminating the pollutants such as volatile organic components (VOC) that exist in coatings. Damaged noncoated parts can be recycled easier because there is no additional cost to remove the coating.

With the economic and environmental advantages, noncoated plastic parts are a desirable choice by OEMs in applications where aesthetics (color, gloss), UV resistance, scratch-and-mar resistance, chemical resistance, and permeation properties are not required. This has led to an increased interest in obtaining aesthetics and physical requirements of plastic parts using alternatives to coatings. However, trying to achieve color, gloss, UV stability, scratch-and-mar resistance, and chemical resistance without using coatings is difficult. Improvements in one property often result in sacrifices in another property. Thus, it results in balancing the trade-off in properties.

In recent years, there have been major advances in alternatives to coatings. These advances are categorized as shown in Figure 1 into two main areas, material development and process development. From a materials perspective, new colorants and modifiers have been developed as additives to plastic resins that provide the aesthetic and physical and chemical properties required. From a process perspective, advances in process technology in areas of extrusion, coextrusion, injection molding, co-injection molding, laminating films, and thermoforming of multilayer sheets have been developed. In this chapter, we will examine these alternatives to coatings.

### **3 MATERIALS DEVELOPMENT**

Advances in additives and colorants have allowed for mold-in-color automotive plastic parts to meet the aesthetic and property requirements of the automotive industry.

#### **3.1 Advances in Property Enhancement Additives**

Additives are added to the polymer matrix to improve the processability of polymers and to improve properties of the final plastic product. In this section, we specifically look at additives that improve specific properties of the final

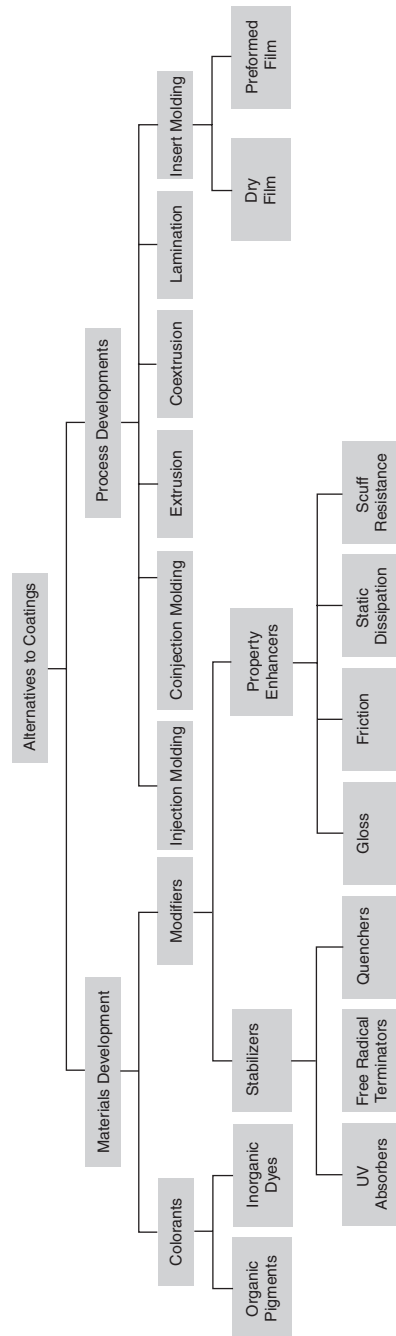

FIG. 1 An overview on alternatives to coatings.

plastic product to eliminate coatings. Additives can be added to improve the scuff resistance. In addition, UV stabilizer additives are used to improve the resistance to UV. Furthermore, additives such as flatteners and metal flakes can be added to the polymer matrix to satisfy the range of low as well as high gloss required for interior and exterior automotive applications.

Advances in light stabilizers have allowed plastics to meet the UV stability requirements in automotive exterior and interior applications. Light stabilizers, which are often referred to as UV stabilizers, are used in a variety of resins to prevent degradation by different wavelengths of light. The more common light stabilizers provide protection against photodegradation caused by UV radiation that is a component of sunlight. The UV radiation can break certain chemical bonds. This creates free radicals that combine with oxygen to form peroxy radicals. The peroxy radicals attack the polymer chains resulting in deterioration of physical and aesthetic properties.

Light stabilizers are divided into three categories: UV absorbers, free radical terminators, and quenchers (2). The UV absorbers will absorb the UV radiation to prevent the formation of free radicals. Hindered-amine light stabilizers (HALS) terminate the free radicals. They are more expensive than UV absorbers. The third category of light stabilizers are quenchers that are often represented by nickel complexes. Because of toxicity of heavy metals and substances of concern (SOCs) specification from OEMs and government regulations, quenchers are not as widely used.

### 3.2 Advances in Colorants

Adding color pigments to plastics can achieve the desired color without the need to coat. Colorants are used to integrally color plastic. Colorants of plastics are divided into two categories—pigments and dyes. Pigments are insoluble organic or inorganic particles that are dispersed and suspended in a resin or compound (3). On the other hand, dyes act as colorants that dissolve in the plastic matrix.

Pigments are either black, white, or different shades of color. Organic carbon black is a commonly used black pigment. A commonly used white pigment, titanium dioxide and zinc oxide, is inorganic. In recent years, several inorganic pigments have been developed with increased thermal and UV stability. The additional features of these inorganic pigments require higher processing costs and selling prices. On the other hand, organic pigments are complex carbon compounds that offer a wide range of colors. Typically, organic pigments have lower cost and lower stability compared to inorganic pigments (3). Dyes are organic and typically provide brighter colors than pigments (3). Dyes are soluble in plastic and are often used to create transparent tints in clear resins. Dyes offer easy processing and dispersion and are often used to make high-

gloss pigment-based colors. However, dyes typically offer poor thermal and UV stability and have a tendency to plate out with high-temperature processing (3).

Colorants are divided into the following categories: dry color, conventional color concentrates, supercons, liquid color, and precolored resin (3). The precolored resin has the color incorporated into the resin when it is received by a processor. The new developments in color have allowed colored plastics to match the painted body colors on automobiles. Straight shade body colors are easier to match compared to metallic body colors.

#### **4 AUTOMOTIVE APPLICATIONS WITH ADVANCES IN MATERIALS**

The advances in property enhancement additives and colorants have led to a number of mold-in-color automotive applications that have traditionally been coated. The term *mold-in color* is commonly used in the automotive industry to refer to plastic parts that have the desired finish and color directly out of the tool or die.

##### **4.1 Mold-in Color for Nonaesthetic Applications**

Initially mold-in color was used in applications where the finish and color were not a concern. These parts involved automotive applications that were not seen by the customer. Applications were splash guards, trunk mats, and other applications that did not have the finish requirements. Inexpensive materials such as polyvinyl chloride (PVC), polypropylene (PP), and recycled materials that meet the performance requirements work well for these applications.

##### **4.2 Mold-in Accent Color**

The advances in property enhancement additives made it possible to meet the performance requirements of automotive exterior and interior applications. With the increased use of accent colors in automotive applications, mold-in color began to be utilized in more automotive applications. The mold-in-accent-color part did not require a color match to the painted body panels. Thus, it was used extensively in exterior and interior trim applications. Accent colors such as gray or black became common in automotive exterior and interior applications. This allowed the molder to manufacture finished parts directly out of the tool or die with the desired gloss and finish. Accent colors became a styling trend and at the same time offered a cost advantage with the elimination of coating. Mold-in color was used for accent color grays and blacks on fascias, moldings, claddings, step pads, bumper rub strips, and rockers for exterior applications. Mold-in-accent-color grained metallic thermoplastic polyolefins have been used in exte-

rior trim as well. Mold-in accent colors have also been used extensively in interiors for applications such as mold-in-color trim panels, door handles, and instrument panels. Polymers such as PVC, thermoplastic polyolefins (TPO), acrylonitrile styrene acrylates (ASA), and ionomers have been very successful for use in mold-in accent colors.

### **4.3 Mold-in Straight Shades Body Color**

Mold-in-color parts that match painted body color have been a challenge. There has been much work done over the years on polymers and pigments that would allow a part to be mold in color and match the painted body finish. Additives were developed that offer UV, chip, and mar resistance. In addition, colorants and pigments have been developed that allow the mold-in-color part to match painted body colors. Complex geometry parts have been extruded and injection molded in straight shade body color. Ionomers have been successfully molded in straight shades body colors of red, black, and white for automotive fascias that match the painted body color. Body moldings, fascias, claddings, and interior trim parts are examples of automotive applications that have successfully used mold-in straight shade body color. Mold-in-color parts are integrally colored, which is advantageous in cases where the surface is chipped or scratched.

### **4.4 Mold-in Metallic Body Color**

Mold-in metallic body color has been a challenge. Extruded mold-in-color trim pieces such as body side moldings have been successful in matching the aesthetics of the painted car body. The automobile industry requires high-gloss (eighty gloss) mold-in-color body side moldings to match the painted car body. Development work on the type and size of metallic flakes by resin suppliers along with development work by the part manufacturer on the process has made this possible. Metallic flakes have a tendency to align and clump together during the processing. Thus, it was important that the material supplier balance the resin carrier viscosity with the ideal metallic flake size in order to establish a process that allows the metallic flakes to align uniformly and match the painted body color. At the same time, the processor had to develop the optimum process that can manufacture an acceptable part as efficiently as possible. In extrusion this has been accomplished with proper screw design, elimination of the breaker plates, and proper die design.

Injection molding of metallic polymer has proven to be difficult. The metallic flakes have a tendency to align in the injection molding process. As a result, the part does not match the painted metallic body color. Proper tool design is required to eliminate metallic flow lines. In addition, the part design is important. A simple geometry part with uniform wall thickness would be best.



## 5 PROCESS TECHNOLOGY

In addition to the material development, there has been significant process technology development. Often it is hard to separate the two. For example, as discussed previously with mold-in metallic body color, not only was there significant development on the material side in terms of size and type of metallic flake, but also on the processing side as well. In the following text, we will discuss the significant accomplishments in process technology that has resulted in alternatives for coating automotive plastics.

### 5.1 Extrusion

Extrusion is a widely used manufacturing process for a number of plastic automotive parts. Advances in the extrusion process has allowed the elimination of coatings in specific applications. Specifically, development work on screw design, die design, and elimination of the breaker plate had allowed General Motors to develop an extrusion process to manufacture high-gloss mold-in-color body side moldings that matched painted body color. General Motors had patented the technology on the extrusion die to achieve the high gloss (4). General Motors also holds a patent on the use of removable film that is used to achieve the desired gloss on an extruded part (5). Process developments in extrusion have open the way for other exterior and interior trim applications that meet the aesthetic requirements right out of the extrusion die.

### 5.2 Coextrusion

Coextrusion is a process that allows for extrusion of two or more materials. Typically, there is a surface layer and a core layer. The core layer often uses a less expensive material and often process regrind material is considered for this application. The surface layer material is chosen to meet the appearance and performance requirements of the part. The surface layer material is usually more expensive because it has the colorants and property enhancement additives to meet the part requirements. With coextrusion process, the thickness of the surface layer is typically minimized to reduce the cost. This has made coextrusion a cost-effective method for mold-in-color parts compared to straight extrusion or coating. The coextrusion process has been successfully used for profile coextruded body-side molding applications.

### 5.3 Injection Molding

Many automotive plastic parts have complex shapes with varying wall thickness. As a result, the parts are manufactured by injection molding. Attention given to design for manufacturing has allowed mold-in-color straight shades to be injection molded. Parts are designed with proper gating and uniform wall

thickness if possible. Further advances in close-loop process controls have made once challenging parts easier to manufacture. In addition, development of sequential valve gating has allowed more control in the plastic filling of the injection mold. As a result, sequential valve gating has been used successfully in mold-in-color metallic fascias and trim components. Parts have been made without metallic streaking.

#### **5.4 Co-injection Molding**

Co-injection molding is a process in which injection molding of parts with a skin of one thermoplastic and a core of another compatible thermoplastic. Like coextrusion, co-injection molding can offer cost advantages by molding the base layer out of a less expensive material and the top layer or surface layer out of another material that offers the appearance and weatherability. The base layer does not require the expensive pigmentation package.

#### **5.5 In-Mold Process Using Dry Films**

A painted dry film is unwound across an open mold. The painted surface of the film is positioned against the mold face. The mold is clamped, and the molten resin is injected into the cavity. As the mold fills, the temperature and pressure of the incoming resin forms the paint film into the shape of the part. When the mold opens, the painted part exits the mold with the paint film bonded to it. This process is limited to applications with simple geometry due to limitations of the film elongation. It has been used successfully in appliqués where the part has a flat geometry.

#### **5.6 Insert Molding Using Dry Films**

A dry paint film sheet is thermoformed and trimmed into the shape of the finished part. The trimmed film (preform) is inserted into the cavity side of the injection mold. The mold is closed and the molten resin is injected into the mold. The backing sheet of the laminate forms a melt bond with the injection molding resin. The part exits the mold with a painted film surface. Using dry paint film, the manufacturer can produce high- or low-gloss parts that match the painted body color. The film offers the scratch-and-mar resistance. Metallic and pearlescent color finishes are available. The first application of the dry film was on a 1994 GMC Jimmy sport utility body side molding to give a brushed-aluminum look (6). In 1995, body side moldings were manufactured to match painted body color. This process is used in production in numerous applications such as side-view mirror housings, side moldings, and other exterior and interior trim applications.

The dry paint film is made by casting a clearcoat and then a basecoat in a reverse rollcoating process. A layer of thermoplastic adhesive is applied behind the basecoat. The cured paint film layers are then laminated to a thermoplastic back sheet. The dry paint film supplied in roll form to the molder and is thermoformed and trimmed into shape of the finished Class A surface. GE Sollx, Dupont Surlyn Reflections, Senoplast Senosan, and Polybond Equistar are just some of the suppliers of dry films on the market.

One must carefully evaluate the overall costs associated with insert dry film molding compared to coating. Dry film molding requires a thermoform tool, a system to place the preformed film in the injection mold, an injection molding tool, and a trim process.

### 5.7 Insert Molding of Coextruded Film

Films (0.2 to 1 mm) and sheets (2 to 5 mm) are coextruded. Coextruded sheets consisting of multilayers are thermoformed and inserted into an injection mold. This process is also referred to as overmolding. It is well established for automotive interiors. There are a number of promising developments for exterior applications. It is applicable for simple geometry parts with large surface area. See Figures 2 (1) and 3 (7).

Advances in both thermoforming and coextruded sheet material have made this a viable process. Advances in thermoforming have improved the process capability to handle mass production. Coextrusion offers a choice of different materials such as reinforced materials and recycled materials. The coloring of the thin surface layer results in a cost savings of the expensive pigments. Film constructions consists of multilayers with each layer having a specific function. For example, there is a surface layer that is clear and functions as a clearcoat. It provides the UV and the scratch-and-mar resistance. It is similar to a clearcoat in painting. The next layer is an adhesive layer. This is followed by a pigment layer that provides the color. Then there is an adhesive layer followed by the base layer that acts as a carrier. A material that offers color, gloss, UV, and scratch-and-mar resistance is required for the top layer of the film or sheet. Polymethylmethacrylate and polyvinylidene fluoride have been used for the top layer. The base layers provide the mechanical and cost requirements. Acrylonitrile butadiene styrene (ABS), acrylic-styrene acrylonitrile (ASA), polycarbonate/acrylic styrene acrylonitrile (PC/ASA), and polycarbonate/polybutylene terephthalate (PC/PBT) have been used as the base layer in order to meet the mechanical and thermal requirements (1). Coextrusion offers a solventless and emission-free process. Coextruded polymethyl methacrylate/acrylonitrile butadiene styrene (PMMA/ABS) films are used in automotive components. BASF, Engel, Rohm, and Senoplast developed Senotop in-mold film in a joint project. It is a PS/ASA blend coextruded with PMMA (8). The film is thermoformed,

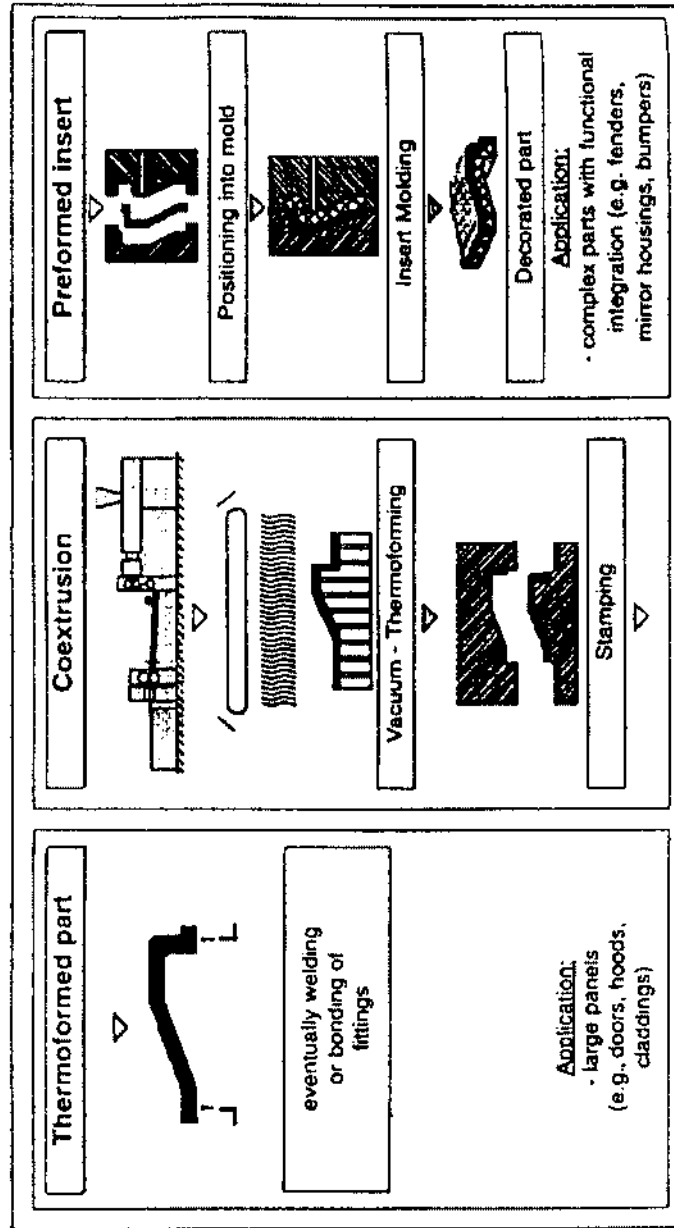

FIG. 2 Process steps for coextrusion of body panels or overmolding films. (From Ref. 1.)

# Process sequence

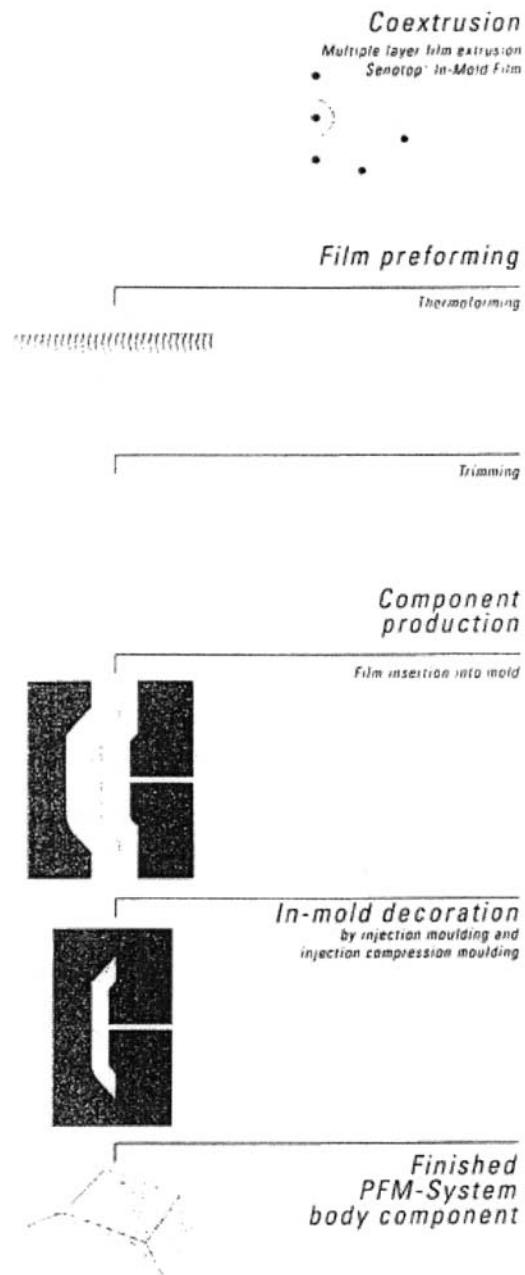

FIG. 3 In-mold process sequence. (From Ref. 7.)

trimmed, placed in an injection mold, and “back injected” with a thermoplastic material. The film has met the colorfastness, UV weathering, gloss, abrasion resistance, water jet, car wash, crosshatch, and gravelometer tests required by automobile manufacturers (9). This technology is used for the roof of the European “Smart Car” subcompact (10).

There exists advantages of films compared to coating. There is easier color matching between different production sites. Allows for rapid color changes. It eliminates the cost and maintenance of a paint line. It is environmentally friendly.

### **5.8 Extrusion Compression Molding with Film Inserts**

A film is placed in a compression mold. Plastic is extruded onto the film. Often times a reinforcing layer such as glass fiber matt is added. The mold is closed. The heat from the extruded plastic will heat the film for forming. The film provides a class A surface part. Films such as polyvinylidene fluoride/acrylic, polyester, ionomer, and ASA have been used.

The Valyi SFC, Surface Finishing/Compression Molding (SFC) process, has demonstrated the capability to manufacture large structural panels such as automotive roof tops, hoods, and trunk deck lids (11). The SFC process can be used to manufacture large class A exterior finishes parts at a low clamp force. The precolor matched films offer the part appearance in the mold, thus eliminating painting.

### **5.9 Thermoform Coextruded Sheets**

A coextruded multilayer sheet is thermoformed. As with films, each layer of the sheet has a specific function. The top layer provides the weathering and UV resistance, scratch-and-mar resistance, hardness, and the gloss. The color layer provides the coloring, additional UV resistance, and adhesion. The base layer provides the structural support. During the coextrusion process, the materials are merged using an adapter system and are shaped by a slit die into sheets of varying thickness (12). Different thermoplastic materials can be combined using this process. Also, the regrind from the thermoforming offcuts can be recycled. After the sheets are coextruded, they are cut to size. The sheet is then heated, thermoformed, and cooled. During thermoforming, the sheet is drawn against the thermoform mold by a vacuum. The surface quality of the thermoformed sheet can equal that of painted panels (12). It must be noted that the surface roughness increases with the depth of thermoforming (12). A thinner residual wall thickness will result in a rougher surface. This will lower the gloss of the finished part. Also, for metallic colors, the greater the number and size of the particles, the rougher the surface (12).

This technology is limited to parts that can be thermoformed. Thermoform

tooling is inexpensive. Achieving a high-gloss level is difficult with the thermoforming process. Body panels made of PMMA/ABS have a proven track record on the Ligier small vehicles in Europe (12). Also, the Hotzenblitz, an electric car in Germany, and the PIVCO, a Norway electric car, have body panels from PMMA/ABS without painting (9). The PMMA provides the UV and weather-resistant outer layer. The impact strength at low-temperature is provided by the ABS layer. The finished body panels are mounted to a steel framework. The plastic body panels provide a weight savings compared to steel body panels (12).

#### **5.10 Mold-In Color with Clearcoat**

General Electric Xenoy PC/PBT with clearcoat polyurethane (PUR) is used to mold body panels for the European "Smart Car." The clearcoat offers the UV and scratch-and-mar protection. Smart Car colors are offered in red, yellow, black, and white straight shades. This process still uses a coating, clearcoat. However, it eliminates the primer and basecoat.

### **6 AUTOMOTIVE APPLICATIONS WITH ADVANCES IN PROCESS TECHNOLOGY**

Advances in the extrusion and coextrusion process have resulted in mold-in-color exterior and interior automotive plastic trim parts. For example, extrusion process is commonly used for mold-in-color body side moldings. Mold-in-color fascias, claddings, exterior and interior trim parts are manufactured by injection molding and co-injection molding. Advancement in both film technology and processing has allowed the manufacture of parts ranging from appliques to whole body panels on vehicles.

### **7 CONCLUSION**

Alternatives to coating automotive plastics have received increased attention in developing new materials and process technologies to meet the demands of the automotive industry. These advances have been used successfully in a number of automotive applications. For example, advances in development of new colorants and additives has allowed mold-in color to be used in more applications such as mold-in accent color, mold-in straight shade body color, and mold-in-body-color metallics. In addition, development of extrusion, injection molding, thermoforming, and insert molding of films processes has allowed OEMs alternatives to coatings for automotive plastic applications. Challenges still remain. For example, color matching is a real concern with mold-in-color plastics both initially and after weathering. In the future, continuous advances in both materials and process technologies will allow alternatives to coatings to make further inroads into the automotive plastic applications that are currently coated.

**REFERENCES**

1. A Grefenstein. Coextrusion of PMMA-coated plastic sheets and films as an alternative to painting of plastic body panels. IBEC '97 Automotive Body Painting, pp 89–91.
2. CJ Reilly. Light stabilizers. Modern Plastics Encyclopedia '97, 73(12):C-24, 1996.
3. J Cafferty. Colorants. Modern Plastics Encyclopedia '97, 73(12):C-20, 1996.
4. General Motors, U.S., 1993 (Thomas Pickett, et al.). Patent number 5,264,164.
5. General Motors, U.S., 1985 (Fred Schmidt, et al.).
6. L DeBow. Honda picks dry paint film for civic side moldings. Automotive Plastics 18: February 2001.
7. The alternative to painting: economical and ecologically friendly. The Senoplast In-Mold Film Brochure, 1997.
8. Alliance develops paintless film systems for auto exterior parts. European Plastics News 25(9):30, 1998.
9. Senotop in-mold films as paint-replacement for injection molded car body parts and car body parts made of fiberglass-reinforced polyurethane. The Senoplast In-Mold Film Brochure, 1997.
10. BASF aktiengesellschaft: paintless film molding. Modern Plastics 70, April 1999.
11. S McCarthy, Q. Guan, C. Makadia, T. Ellison. Class A thermoplastic automotive part production without painting. ANTEC 2654, 2000.
12. H Kappacher. Car bodies made of PMMA/ABS. Piesendorf/Austria.



# 9

## Trends in Coatings for Automotive Plastics and Rubber in North America and Europe

**Robert Eller**

Robert Eller Associates, Inc., Akron, Ohio, U.S.A., and Bordeaux, France

### 1 INTRODUCTION AND OBJECTIVES

In this chapter we examine the forces driving the selection of coatings and associated process technology for the modification of plastics and rubber surfaces. Primary emphasis is on the North American auto industry. Where the technology and trends are applicable to (or derived from) nonauto markets, we have so indicated.

#### 1.1 Geographic Coverage

The need to be competitive in the global marketplace has made the barriers to technology transfer quite transparent. We have therefore indicated and, in some cases, quantified material substitution trends in Japan or Europe likely to affect North American coating technologies and the associated demand.

#### 1.2 Trends

We have sought to present a view of the future as seen from the perspective of our recent work in the automotive sector. Where the current implication of future trends is not clear we have so indicated and sought to define the decisive factors.

#### 1.3 Substrate Type

Coatings for both plastics and thermoset rubber are included. Because the interface between thermoset rubber and plastics is becoming blurred by the use of

thermoplastic elastomers (TPEs), we have included these materials in the scope of the automotive polymers to be coated.

#### 1.4 Definitions

We have used the term *coating* to include not only liquid coatings and paints but also skins, textiles, and other materials designed to modify the surface properties and characteristics of automotive polymers in interior soft trim and exterior applications. A summary of the abbreviations used and a list of references is given in the glossary at the end of the chapter. Non-English terms (usually German or French) are commonly used without translation to characterize surface qualities. Their definitions are also included in this chapter's glossary.

## 2 THE DYNAMICS OF COATING SELECTION

### 2.1 Functions

Coatings on the polymer substrate provide some or all of the functions described in Table 1.

**TABLE 1** Functions of Coatings for Automotive Polymers

| Function                 | Note/Example  |
|--------------------------|---|
| Color                    | Competes with molded-in color   |
| Introduce texture        | Usually with textiles, skins, coated fabrics  |
| Introduce pattern        | Recently molded-in patterns<br>Dry films (e.g., wood grain)                                 |
| Gloss control            | Needed for polyolefin-based skins   |
| Scratch/mar resistance   | Needed for polyolefin substrates<br>Elimination is major research and development objective |
| "Touch" modification     | <i>Haptik</i> in German   |
| UV protection            | Requirements increased with longer warranty   |
| Mold release             |   |
| Adhesion of flocking     | For thermoset rubbers in window channels  |
| Control surface friction | For movable windows   |
| Eliminate ice adhesion   | Body/glazing seals  |
| Modify surface acoustics | Gaining importance in interior surfaces   |
| EMI shielding            | Will grow with electronics content, telematics  |
| Acoustic modification    | Applies to all surfaces   |
| Wear surfaces            | e.g., noncarpet flooring  |

Source: Robert Eller Associates, Inc., 2001.

## 2.2 The Plastic Processor's Perspective

For the plastics processor, the application of coatings to the surface of molded parts adds cost, the uncertainties of adding liquids and the associated "wet chemistry," and an additional operation that increases capital investment and broadens the quality control requirements.

Some (usually large) plastic processors have turned this burden into a competitive advantage by installing high-volume, highly automated, closely controlled spray booths, which contribute to profitability and provide an entry barrier against smaller competitors. (Bumper fascia fabricators are an example of such large volume molder/coatings suppliers.) Roll goods manufacturers apply coatings to skins or coated fabrics using spray or reverse roll coating.

## 2.3 The Automotive Coatings Market

Liquid coating materials, process technologies, and performance requirements are reviewed in other chapters of this book. The dynamics and economics of plastic and rubber parts manufacturing require that the design engineer examine alternatives to liquid coatings such as:

- Molded-in color (see Chapter 1);
- Surface skins, textiles, and coated fabrics applied off-line (see following discussion); and
- In-mold decoration using films, carpet, textiles (see following discussion).

The auto polymer coatings market has been (1) defined in terms of substrate type (hard/soft), substrate material (polymer type), and module (instrument panel [IP], door trim [DT], floor). A summary of the applications that use liquid coatings and the alternatives is presented in Figure 1. The target zones in interiors and exteriors for coatings are summarized in Table 2.

## 2.4 The Measurement Problem

The driver typically spends 40,000 hours at the steering (2) wheel facing the instrument panel. The choice of surface treatment (hard, soft, textile, patterned, colored, etc.) is therefore critical to the auto original equipment manufacturer (OEM).

Physical and chemical tests quantify technical performance (scratch/mar, ultraviolet (UV) resistance, oil resistance, color shift, etc.). Despite the economic importance of surface treatment selection, techniques for the quantification of sensorial attributes of the interior surface to measure their importance to the consumer have not been developed. Renault and other OEMs (3,4) have employed techniques derived from methods used in the agro-business sector to

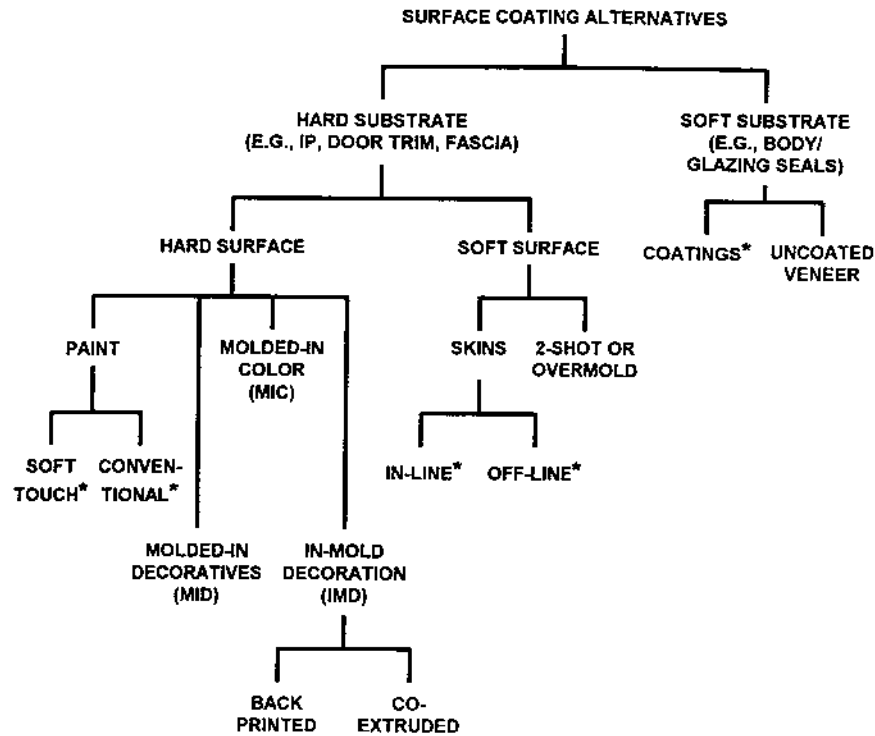

Fig. 1 Automotive plastic coating alternatives. Note: (\*) indicates liquid coatings opportunity target. (Courtesy of Robert Eller Associates, Inc., 2001.)

identify and quantify the sensorial attributes and their perception by humans. The techniques are in the early stages of development and only vaguely quantified, but appear to represent a starting point to the response to such questions as:

- What is the perceived value to justify the cost penalty for substituting a skin for hard substrate?
- Do the customers care about exact grain matching as much as the interior trim designer?
- What is the role of color and pattern matching between modules?
- What is the value of the utility function (e.g., washable, noncarpet floor module surfaces)?
- What is the value of touch (“haptik”) in consumer quality perception?
- What is the role of olfactory perceptions (some OEMs are seeking zero smell interiors)?

TABLE 2 Target Zones and Alternatives to Coatings on Automotive Polymers

| Location                           | Sub type | Typical form      | Example | Liquid coating competitor |     |                |                |     |    |     |      |      |  |  |  |                |   |   |
|------------------------------------|----------|-------------------|---------|---------------------------|-----|----------------|----------------|-----|----|-----|------|------|--|--|--|----------------|---|---|
|                                    |          |                   |         | IMD                       | MIC | 2SHT           | SKINS          | TEX | CF | CPT | LTHR | COEX |  |  |  |                |   |   |
| Exterior                           | Flex     | Fascia            |         | X                         | X   | X <sup>b</sup> |                |     |    |     |      |      |  |  |  |                |   |   |
|                                    | Rigid    | Trim <sup>a</sup> |         | X                         | X   | X <sup>b</sup> |                |     |    |     |      |      |  |  |  |                |   |   |
| Interior                           | Rigid    | Instrument panel  |         | X                         | X   | X              | X              | X   |    |     |      |      |  |  |  |                |   |   |
|                                    | Flex     | Door trim         |         | X                         | X   | X              | X              | X   | X  |     |      |      |  |  |  | X              |   |   |
|                                    |          | Instrument panel  |         | X                         | X   | X <sup>e</sup> | X              | X   | X  |     |      |      |  |  |  | X <sup>c</sup> |   |   |
|                                    |          | Seating           |         | X                         | X   | X              | X              | X   | X  |     |      |      |  |  |  | X              |   |   |
| Interior/<br>exterior<br>interface | Coat fab | Headliner         |         |                           |     |                | X <sup>d</sup> | X   |    |     |      |      |  |  |  |                |   |   |
|                                    | Textile  | Flooring          |         | ?                         | X   |                | X              | X   |    |     |      |      |  |  |  |                |   |   |
|                                    | Sheet    | Glaze seal        |         |                           | X   | X              | X              | X   |    |     |      |      |  |  |  |                | X |   |
|                                    | Flex     | Body seal         |         |                           | X   | X              | X              | X   | X  |     |      |      |  |  |  |                |   | X |
|                                    |          | Glaze seal        |         |                           | X   | X              | X              | X   | X  |     |      |      |  |  |  |                |   | X |
|                                    |          | Body seal         |         |                           | X   | X              | X              | X   | X  |     |      |      |  |  |  |                |   | X |

<sup>a</sup>For example rocker panel, cowl vent, rear panel, pickup truck box.

<sup>b</sup>Two-shot sandwich molding for rocker panel (TPE on ETP) starting in Europe. Two shot (side by side) is often used in fascia molding.

<sup>c</sup>Leather used on some European high-end IP models in Europe.

<sup>d</sup>Skin usage for headliners has essentially declined to zero except in some heavy truck applications.

<sup>e</sup>Two-shot molding for instrument panels started in mid-1990s. Will likely grow.

Source: Robert Eller Associates, Inc., 2001.

### 2.5 Requirements for Interiors and Exteriors

Liquid coating technologies used on interior and exterior plastic surfaces are somewhat similar. The range of nonliquid coating surface treatments and performance requirements for interior and exterior automotive surfaces is considerably different as shown in Table 3.

## 3 DRIVING FORCES AND TRENDS IN COATING USAGE

The macro-economic, automotive technology and module fabrication technology driving forces and trends affecting coating use and intercoating competition are reviewed in Table 4 (1).

**TABLE 3** Interior/Exterior Coating Requirements/Opportunities

| Parameter                   | Interior                                       | Exterior                       | Note   |
|-----------------------------|--|--------------------------------|--|
| Soft trim opportunities     | X  |                                | Skins  |
| Accurate grain reproduction | X  |                                | Decreased requirement for grain matching       |
| Acoustics                   | X  |                                | Requirements increased by growth of telematics |
| Liquid coating on soft trim | X  |                                |  |
| Substrate type              | Hard/soft                                      | Hard                           | Soft: rubber, TPE, skins                       |
| Zero smell requirements     | X  |                                |  |
| Scratch/mar                 | X  | X                              | Different requirement levels                   |
| Match painted body metal    | X (Some applications)                          | X                              |  |
| Tactile requirement         | X  |                                |  |
| Fluid resistance            | X  | X                              | Different fluids                               |
| Dominant substrate          | ETP, PP (solid/foam), TPE, skins, coat fabrics | TPO (fascia), thermosets, ETPs |  |
| NVH requirements            | Important                                      | Not important                  |  |
| Surface parts integration   | X (More opportunities)                         | X (Highly integrated)          |  |
| Wood grain                  | X  |                                |  |
| Brushed metal               | X  | X                              |  |
| Metallic pigments           | X (Minor)                                      | X (Major)                      |  |
| Coated fabrics              | X  |                                | Liquid coating opportunity                     |
| Skin/foam/substrate         | X  |                                |  |

Source: Robert Eller Associates, Inc., 2001.

**TABLE 4** Driving Forces and Trends Affecting Coatings for Automotive Polymers

| Trend/driving force                  | Coating type/module affected                    | Coating implications  |
|--------------------------------------|---|---|
| European ELV legislation             | Skins, coated fabrics                           | Favors:<br><ul style="list-style-type: none"> <li>—Recyclable plastic use</li> <li>—Monomaterial constructions</li> <li>—PVC substitutes</li> <li>—Reduction of liquid coatings</li> <li>—Favors in-mold processes</li> <li>—Favors in-line soft trim processes</li> <li>—In-mold appliquéés, logos</li> <li>—Favors lightweight floor acoustics<sup>a</sup></li> <li>—On-module acoustics</li> </ul> |
| Cost reduction                       | All   | Low-cost production differentiation:<br><ul style="list-style-type: none"> <li>—Logo in skins, grain variations, colors, patterns, molded-in decoratives</li> <li>—Favors PVC-substitute skins</li> <li>—Growth to 40 percent of fleet in Europe</li> <li>—Surface skins/textiles</li> <li>—Substrate structure</li> </ul>  |
| Weight reduction                     | Acoustic modules                                | —Originate in German OEMs (e.g., Audi)  |
| More models/common platform          | Skins   | —Favors non-PVC skins/coated fabrics  |
| Invisible airbag door                | Instrument panel skin                           | —Adjustment of spray PU and TPU formulas  |
| Increased telematics                 | All, acoustic performance                       | —Favors non-“itch” surface treatments   |
| Reduction of liquid coatings         | All interior skins, coated fabrics              | —Metallic flake match difficult   |
| Hydrocarbon emission reduction       | Interior skins, coated fabrics                  | —Favors TPE substitution for rubbers  |
| Elimination of off-line skin forming | Interior skins                                  | —Technical grains on interior skins   |
| Reduction of NVH                     | All interior trim                               | —Washable noncarpet flooring  |
| Energy management                    | Exterior, seals                                 | —Driven by telematics/electronics   |
| Match to painted metal               | Interior soft trim exterior in-mold improvement | —Affects surface and substrate sandwich   |
| Injection mold process control       | Interior  | —Wood grain, technical grain  |
| Increased “utility”                  | Interior soft trim                              | —Audi TT  |
| Acoustic control                     | Interior, exterior trim                         |   |
| Retro look                           |   |   |

<sup>a</sup>For example, offered by Collins & Aikman, Lear, Reiter, others.  
Source: Robert Eller Associates, Inc., 2001.

### 3.1 ELV Legislation and PVC Substitution

PVC is widely used in North American vehicles. A quantification by application has been previously reported (5). The implications for PVC in auto interior applications from existing or anticipated European legislation has been discussed previously (5,6). European End-of-Life (ELV) legislation has been among the main drivers for the search for PVC substitutes in interior applications.

The General Motors announcement in mid-1999 of their intention to minimize PVC in interiors by Model Year (MY) 2004 has prompted substitution for PVC in instrument panel and door trim skins. See discussion of intermaterials competition in skins below (Section 4.1). PVC compounds are becoming more sophisticated (higher flow, better color control, improved compression set) and are gaining share in some applications (e.g., glazing encapsulation, blow-molded interior components). Also, PVC remains a highly cost effective competitor, and this has resulted in considerable difference in the policies of automotive OEMs with regard to PVC substitution policy.

In mid-2001, German OEMs and legislators reached an agreement on an ELV automotive recycling bill that is more severe than the previous European Union (EU) directive. In particular, it shifts the responsibility for dismantling and recycling to the automakers rather than the vehicle owner. The implications of the revised German legislation on interior substitution have been reviewed by the author (7). Ryntz reviewed recycling implications on coatings in Chapter 7 of this book.

### 3.2 Economics as Coating Substitution Driver

The high capital investment and operating cost burden of coatings can double the cost of molded parts (e.g., bumper fascia and IP substrates). Substitutes for coatings thus have a wide economic window in which to seek profitable material substitutions.

### 3.3 Acoustics

Acoustic performance has often been an afterthought rather than an integral part of the initial vehicle design. A broad range of acoustic materials is used (8). This has often resulted in messy solutions with high systems costs (e.g., asphalt-based floor module acoustic barriers). Increased use of telematics, improved acoustic profiling techniques, and a better understanding of acoustic performance as well as increased pressure for weight reduction are creating opportunities for new acoustic materials combinations.

Weight savings assume increased importance in a high fuel cost environment. A weight increase of 100 kg increases fuel consumption by 0.6 liters/100 km. This has stimulated the development of below-the-surface acoustic barriers



that provide acoustic performance (especially in floor modules) with less weight addition. These lightweight acoustic barriers have been introduced by Collins and Aikman, Lear, and Rieter (1).

Coating selection contributes to interior acoustic performance (1,9). Increased use of telematics has made characterization of acoustic behavior a performance parameter for the selection of interior coatings.

### 3.4 Instrument Panel Fleet Shares

A quantification of the shares of instrument panel production is given in Table 5. Hard (nonskinned) surfaces have typically represented 30 to 40 percent of vehicle production (1,10). Hard IPs represent substantial cost savings versus soft IPs (11) and are used at the lower end of the trim range. The recent trend toward a more utilitarian look in smaller vehicles (compact sedans, compact SUVs) and cost pressures from a deflationary economic environment suggest that the share of hard IPs in the fleet will remain at least at the present level. This creates an opportunity for coating treatments capable of providing improved sensorial appreciation and acoustic performance without the need for skins. The trend toward soft-touch paint as a low-cost alternative to skins (e.g., Ford Focus) has not gained much momentum to date.

### 3.5 Role of the Interior Soft Trim Fabrication Process

Soft interior trim typically consists of a three-layer sandwich of skin (or textile), foam, and substrate. Off-line processes that combine these three layers to produce interior soft trim are complex, multistep, wasteful, and labor intensive. The rate of change of interior module fabrication processes during the past twenty years has been slow (10–12) but is accelerating and will influence the choice of skin material and process technology. The relationship between fabrication process technology and skin type is shown in Figure 2. The off-line technologies are currently predominant. The trend is toward the in-line technologies. In-line processes with fewer, more efficient operations have been slow to be accepted for instrument panels but have gained share in door-trim manufacture. These include:

- Low-pressure molding (combining skin and substrate in the injection mold);
- Two-shot molding (also starting to be used in exterior trim, e.g., rocker panels in European models);
- Negative forming to improve grain quality of vacuum-formed skins; and
- In-mold coated (IMC) cast skins that combine the formation of a slush molded (or PU spray skin) with subsequent PU-RIM molding in the same mold to form the substrate layers.

**TABLE 5** Instrument Panel Skin Processes/Materials Shares in Europe and North America

| Material type             | Process types     | Market, share,<br>% (MY 01) |            | Note/status              |
|---------------------------|-------------------|-----------------------------|------------|--------------------------|
|                           |                   | Europe                      | N. America |                          |
| PVC                       | Calender          | 57                          | 61         | Dominant share           |
|                           | Extrusion         |                             |            |                          |
|                           | Slush molded      |                             |            |                          |
|                           | Cast <sup>b</sup> |                             |            |                          |
| Hard/nonplastic           |                   | 31                          | 35         |                          |
| TPO                       | Vac form          | 4                           | 1          | Dominant share           |
|                           | Slush molded      | 0                           | 0          | Starting in Japan        |
| Polyurethane <sup>c</sup> | Spray             | 8                           | 2          |                          |
|                           | Slush molded      |                             |            | Penetration accelerating |
|                           | RIM               |                             |            | Not yet commercial       |

<sup>a</sup>Based on 2001 model year.

<sup>b</sup>Cast and gelled from PVC plastisol; often called unsupported expanded vinyl (UEV).

<sup>c</sup>Both thermoset (e.g., spray) and thermoplastic (e.g., TPU slush).

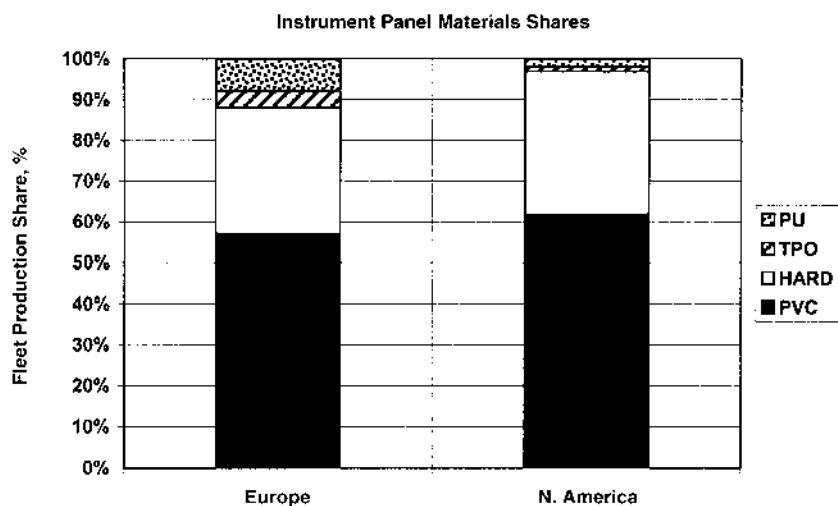

Source: Robert Eller Associates, Inc. U.S., Europe Multiclient Studies.

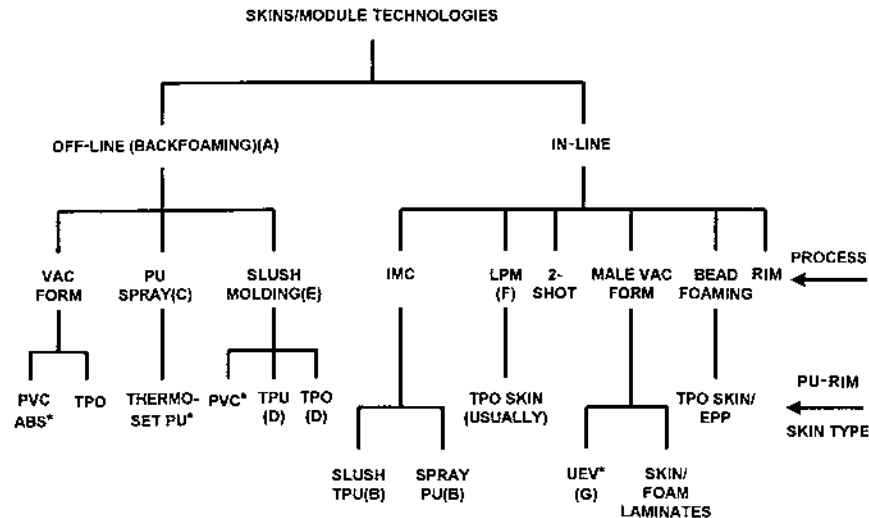

FIG. 2 Interior skin materials and process options for instrument panel and door trim. Notes: (\*) indicates incumbent; (A) the dominant process; (B) evolving processes; (C) Recticel process; (D) double slush processes evolving; (E) also called casting; (F) low-pressure molding, primarily used for door trim, starting in IPs; and (G) unsupported expanded, integral skin PVC, lowest-cost skin candidate (sometimes called casting). (From Ref. 1.)

## 4 INTERCOATING COMPETITION IN SELECTED MODULES

### 4.1 Interior Skins (Instrument Panel, Door Trim)

#### 4.1.1 IP Skin Competitors

PVC is, by far, the dominant incumbent in IP skin manufacture using either the thermoforming or PVC slush molding process. The estimated market shares for the material/process combinations challenging this incumbent position are quantified for the current North American and European markets in Table 5.

#### 4.1.2 Vacuum Forming

Vacuum forming has and is likely to continue to lose a share of both the European and North American fleets. The trend line based on REA's European instrument-panel database multi-client study (10) is illustrated in Figure 3 for the European market. Vacuum-formed TPO skins (both compact [skin only] and composite [skin/foam laminates]) have gained some share at the expense of PVC/ABS skins, but this has not arrested the decline of vacuum-formed IP skins in favor of slush molding. Negative forming (e.g., Honda Civic IP skin) has

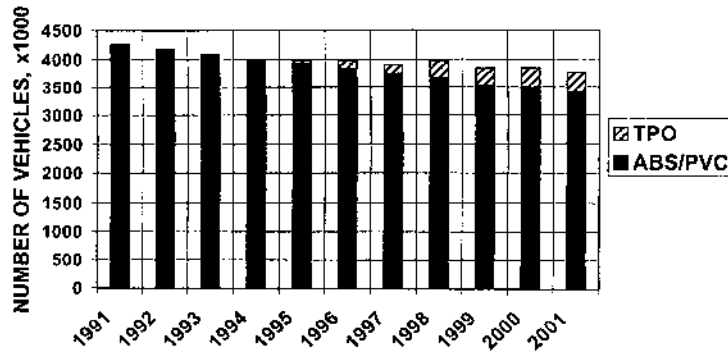

Fig. 3 Demand trends in European vacuum formed IP skins. (From Ref. 10.)

demonstrated the capability to obtain improved grain retention of TPO and PVC skins during vacuum forming. This technology, which was on several models in the North American fleet in MY 2002–2004, was initially used with off-line methods. Visteon and others are using negative forming methods combined with in-line low-pressure molding. Such combinations will likely reduce the rate of decline of vacuum forming for the production of skins.

#### 4.1.3 Slush Molding

The rapid growth of dry powder, PVC slush molding of interior skins in both the European and North American fleets began in the early 1990s as illustrated in Figure 4.

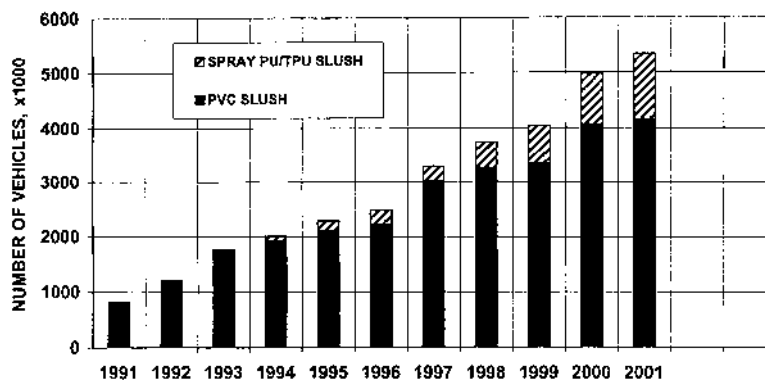

Fig. 4 Demand trends in European spray/slush molded IP skins. (From Ref. 10.)

The TPU slush-molded skins were first introduced in the North American fleet (MY 1998, Chrysler LH-Series) by Textron. The growth for the slush molding process continues in Europe, North America, and Japan, but as shown in Figure 4, PVC slush is being challenged by:

- Spray PU (from Recticel);
- Succeeding generations of TPU slush molding compounds (currently on fourth generation) with improved performance and shorter cycle times; and
- TPO slush (initial penetrations in the Japanese fleet started in MY 2002).

The invisible airbag door will gain share in both the European and North American fleets. Penetration will reach 40 percent (on both soft and hard IPs) in the European fleet in MY 2005 (10). Penetration will be slightly less in the North American fleet for the same year. The ability to be deployed at low temperatures ( $-35^{\circ}\text{C}$  to  $-40^{\circ}\text{C}$ ) without the generation of small fragments is a key performance requirement that cannot be met with current PVC formulations.

#### 4.1.4 Prior First Steps

Early substitutions can be indicators of material use trends. Some examples of key interior skin substitutions in the European and North American fleets are given in Table 6.

#### 4.1.5 Door Trim Panels

Many of the performance requirements are different for DT and IPs. More importantly, some of the technologies for fabricating the substrate and eventually the multilayer sandwich differ between these interior modules. The result is that the rate of material substitution for skins is different between DTs and IPs as illustrated in Table 7 (7). The fabrication technologies for DT panels:

- Are more advanced (with respect to the shift toward reduced process steps);
- Differ substantially between North America and Europe (more cellulosic [about 50 percent of DT substrates] in Europe) (1);
- Allow more innovation in skin technology (e.g., TPOs penetrated in European DTs first);
- Must have lower cost (e.g., in Europe UEVs have a high share);
- Must integrate multiple surfacing materials (carpet, skins, hard injection molded inserts); and
- Must conform to tighter space (e.g., thickness) restrictions.

From an esthetic perspective, the DT panel skin had been thought to require a close match with the instrument panel skin with respect to color, aging, grain, etc. Often, but not always, the same skin material was chosen for both

TABLE 6 Trend Setting Initial Interior Substitutions

| Tech                              | Module | OEM        | Model            | MY             | Location |               |       | Note   |
|-----------------------------------|--------|------------|------------------|----------------|----------|---------------|-------|--|
|                                   |        |            |                  |                | Europe   | North America | Japan |  |
| VF-TPO                            | DT     | DCX        | E-Class          | 1995           | X        |               |       | —Mitsui technology   |
| Spray PU                          | IP     | BMW        | 5-Series         | 1995           | X        |               |       |  |
| TPU slush                         | IP     | DCX        | LH               | 1998           |          | X             |       | —Generation 1<br>—Invisible airbag door                                  |
| TPO slush                         | IP     | NISS       |                  | 2000           |          |               | X     |  |
| TPU slush                         | IP     | Ford       | Jaguar<br>S-type | 1999           | X        |               |       | —First in Europe<br>—Generation 2  |
| First all-hard                    | IP     | DCX        | Neon             | 1996           |          |               | X     | —Europe already had high penetration of PP IPs                           |
| VF-TPO                            | IP     | DCX        | Mercedes<br>SUV  | 1999           |          |               | X     | —First in North America  |
| TPO                               | FLR    | Several    |                  | 2002 –<br>2003 | X        |               |       | —Rapid growth module for TPO   |
| PVC, TPU<br>slush tech.<br>grains | IP     | Several    |                  | 1998           | X        |               | X     | —VW Beetle<br>—Ford Mondeo   |
| Multigrain                        | IP     | Several    |                  | 1999           | X        |               |       | —Strong growth trend<br>—Ford Mondeo (MY 2001)<br>—DCX Liberty (MY 2002) |
| TPV                               | Seal   | Toyota     | Yaris            | 1999           | X        |               |       | —Many other examples since   |
| COEX                              | Seal   | Mitsubishi | SUV              | 1997           |          |               | X     |  |
| SEBS inject                       | Seal   | BMW        | 5-Series         | 1997           |          |               | X     | —Rear quarter window   |

Source: Robert Eller Associates, Inc., 2001.

**TABLE 7** Door Trim Panel and Instrument Panel Technology Impact on Skin Process Selection

| Factor                             | Door trim   | Instrument panel  |
|------------------------------------|---|---|
| Substrate:                         |   |   |
| Europe                             | <ul style="list-style-type: none"> <li>—Cellulosic 50 percent</li> <li>—allows sandwich molding</li> <li>—Low percent low-pressure molding</li> </ul>                               | —Injection molding PP dominates   |
| North America                      | <ul style="list-style-type: none"> <li>—Injection molded—requires positive thermoform skin</li> <li>—LPM → skin/foam laminate</li> <li>—S-RIM about 10 percent (GMT 800)</li> </ul> | —Injection molding ETBs dominate  |
| Substrate processes                | <ul style="list-style-type: none"> <li>—Several</li> <li>—Low-pressure molding<sup>a</sup></li> <li>—PP high share</li> </ul>   | <ul style="list-style-type: none"> <li>—Dominated by injection molding</li> <li>—PP low share in North America</li> </ul> |
| Invisible airbag door              | Not a significant factor  | —Major skin selection criterion   |
| Surface types                      | —Several: (carpet, textile, skin)   | <ul style="list-style-type: none"> <li>—Usually single type</li> <li>—Multitexture starting</li> </ul>                    |
| Skin                               | <ul style="list-style-type: none"> <li>—Desirable to match IP in high-end models</li> <li>—Match not needed in low-end vehicles</li> <li>—Higher TPO penetration</li> </ul>         | —PVC (slush and thermoform dominate)  |
| TPO skin/foam laminate penetration | —Higher (positive thermoform and low-pressure mold)   |   |
| Dominant skin-forming process      | —On-line positive thermoforming   | —Off-line   |
| Esthetic impact                    | —Less   | —Higher   |
| UV exposure                        | —Less   | —Higher   |
| Structural requirement             | <ul style="list-style-type: none"> <li>—Lower</li> <li>—Allows more innovation</li> </ul>   | —Higher   |
| Carrier for value-added components | —Minor  | —Major  |

<sup>a</sup>Opportunity for TPO/foam trilaminates; Visteon, Haartz early leaders.  
Source: Robert Eller Associates, Inc., 2001.

(e.g., spray PU at BMW). The recent trend toward multiple grains (see the following discussion) suggests that this requirement will ease in future models.

#### 4 FLOOR/ACOUSTICS MODULE

The floor module plays a key role in interior acoustic performance. Traditional floor module constructions (carpet, PU foam, asphaltics, highly loaded EVA) are being challenged by a wide range of new materials for both the surface and the substrate sandwich.

##### 4.2.1 Floor Surface

The traditional role of carpeting plus rubber or PVC mats as the flooring surface is being challenged by noncarpet alternatives (1) based on olefinic TPEs capable of a more utilitarian function (e.g., washable) and decorative look (colors, printed patterns, and molded-in decorative effects). Polypropylene carpet floor surfaces are increasing their share of the market (13), further supporting the drive for mono-material construction based on polyolefins.

##### 4.2.2 Floor Substrate Acoustic Barrier Sandwich

The classical approach to acoustic management in the floor (and other) modules has relied on a sandwich of low density and highly filled, high-density materials that imposed a substantial weight burden. The rapid rise in fuel prices in North America (2000–2001) drove the development of alternative lightweight combinations for both floor (and headliner) acoustic applications. In floor systems, these lightweight acoustic barriers are likely to find application in combination with both carpet and noncarpet surfacings.

The floor module thus represents a growth potential for polymers capable of meeting the requirements for:

- Foamability (to low densities),
- Formability at high filler loadings (note need for low melt viscosity),
- Compatibility with other layer materials (TPO surface layers, carpet backing, etc.),
- Acoustic performance and tunability, and
- Low cost (to compete with EVA and asphaltics).

Polyurethane foams have made an early penetration into several acoustic barrier sectors on the basis of moldability and acoustic tunability (Huntsman, Collins & Aikman at Rover) in floor systems.

Glass-fiber batting is being challenged by alternative materials (8) in several acoustic applications (under hood, dash mat) on the basis of:

- Workplace safety,
- In-plant handling problems,



- Limited compatibility with other layers in multilayer constructions,
- Smell (related to the binders used in glass-fiber batting), and
- Attachment limitations.

### 4.3 Coated Fabrics

The PVC-coated fabrics are widely used in for automotive applications (primarily seating). Coated fabrics represent a large potential market for TPO and some competitors (e.g., ethylene styrene interpolymer [ESIs]). This sector has not been penetrated, to date, by non-PVC alternatives due primarily to high stiffness, poor radio frequency (RF) sealability, and a cost penalty versus PVC. Recent compound developments and receptivity by auto OEMs in Europe suggest that penetration of the coated fabrics sector by TPOs may begin in the next model year in seating, security shade, and sun visor applications. In sun visor applications, the recently developed ability to achieve RF sealing with TPOs (adopted from medical sheet applications) combined with compatibility with polyolefin foams provides advantages that partially offset the cost disadvantages of TPO-based systems. These TPO-coated fabrics require protective coatings. Recently developed techniques for printing on TPOs in nonautomotive applications are being examined for their suitability for auto interior surface decorating, usually as a back-printed surface film.

### 4.4 Acoustic Barriers

Acoustic barriers consist of a low-density layer and a heavy (usually highly filled) layer. Glass fibers, foams, EVA, SEBS compounds (injection molded), asphaltics, and thermoset polyurethanes are used.

Current cost reduction demands point toward an “on-board” or “on-module” acoustic system integrated with the original layer structure of the module. This economic drive combined with the benefits of a monolithic, multilayer design bring a market growth opportunity for low-cost olefinic TPEs to compete with incumbents on the basis of:

- Monomaterial construction, especially in all polyolefin floor systems (13);
- Acoustic tunability (currently possible with polyurethanes); and
- Injection molding or extrusion compression processes.

Highly filled SEBS compounds at GM and DaimlerChrysler in North America (6) are currently used for injection-molded acoustic barriers in North America. This application has not grown in the European market. The broader rheology control from the newer generation of TPOs based on metallocene catalysis may have the capability of enhancing the competitive position of the TPOs in this growth sector for injection molded acoustic barriers.

## 4.5 Body and Glazing Seals

### 4.5.1 Markets

Automotive body and glazing seals represent a market potential of approximately 120,000–140,000 tons in each of Europe and North America (6) and have the potential for substantially increasing TPE (primarily TPV) usage.

### 4.5.2 Incumbents and Challengers

Body seals are the stronghold of EPDM extruded profiles. A range of incumbents (PVC, EPDM, PU-RIM) is used in glazing seals (12,14). Some of the vehicle positions in which these applications are used are illustrated in Figure 5. Some of these are in close proximity and are becoming integrated with interior panels. The belt line molding at the base of the movable door window is an example as shown in Figure 6. The TPVs will be the dominant TPE in automotive seals, used either as veneers or as foam/solid profiles alone, or in combination with EPDM. As veneer, SEBS may have a role.

While more expensive than EPDM, the TPVs have the potential for system cost savings by cofabrication (injection, extrusion) with the rigid component. The improvement of foaming technologies (smooth skin, uniform cell size, accurate profile shaping, as well as improved abrasion resistance) is facilitating penetration of this sector. It is, however, still difficult to obtain the low compression set required for primary door seals with TPVs.

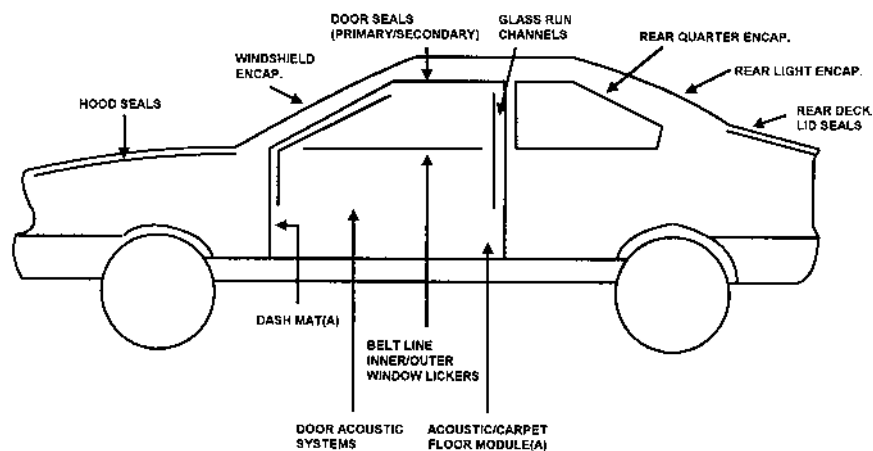

FIG. 5 Potential penetration points for TPEs and associated coatings in body, glazing seals, and acoustic systems. Note: (A) acoustic opportunity. (Courtesy of Robert Eller Associates, Inc., 2001.)

**PRIMARY DOOR SEAL WITH TPE VENEER:****OUTER/INNER BELT MOLDINGS:**

FIG. 6 Cross-sections of body seals. (Courtesy of Robert Eller Associates, Inc., 2001.)

#### 4.5.3 Role of Colors

The use of high concentrations of carbon black as the reactive reinforcing agent in the vulcanization of thermoset rubber eliminates the possibility of obtaining colors. Concentrations as low as 1 percent carbon black turn rubber black. The desire for colors as well as the potential for system cost savings using thermo-plastic processing and rigid/flexible combinations have encouraged the use of TPEs in body and glazing seals.

#### 4.5.4 Roles of Coatings

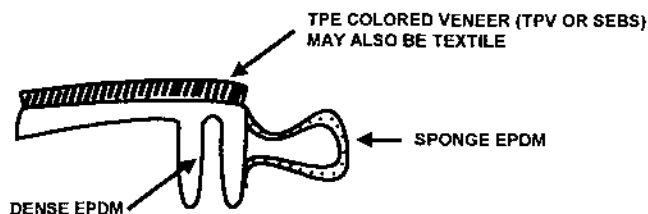
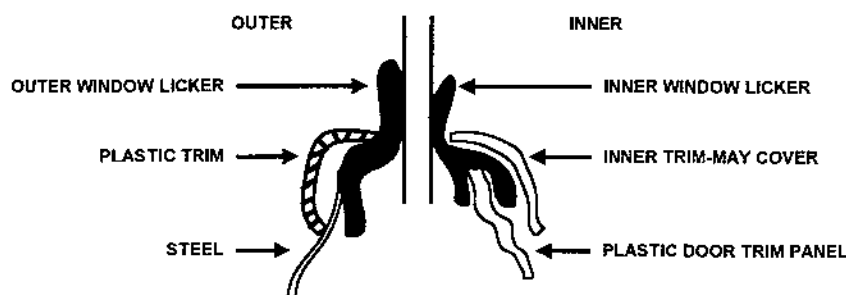
Coatings on the incumbent rubbers are used to control gloss, ice adhesion, surface friction (e.g., for movable glazing), and to provide adhesion for flocking and glass (in fixed glazing). New coatings capable of performing the required functions on TPE substrates are finding application in body and glazing seals. In some cases, system cost savings can be achieved through the elimination of previously used portions of the system (e.g., movable TPE glazing seals without the flocking normally used with EPDM glazing seals).

## 5 TRENDS IN COATING USAGE

### 5.1 Multigrain

For instrument panel and door trim skins, “technical” grains having a geometric (e.g., diamond or square) pattern were introduced in the late 1990s as a substitute for imitation leather grains that have dominated interior skin surfaces for 30 years.

The Volkswagen Beetle was an early example of the use of technical grains. Many others have followed.

Matching the grains on adjacent surfaces as closely as possible was an important objective for many years. Not surprisingly, this proved to be extremely difficult (e.g., injection molded plastic versus thermoformed PVC/ABS skin and separate airbag door). Early 2001 designs utilized and deliberately emphasized different grains from position to position on the IP or DT. Grain differences are often found on the same skin molded in the same mold. Ford Mondeo (MY 2001) (Textron) and DCX Jeep Liberty (molded by Johnson Controls) instrument panels are examples from Europe and North America.

### 5.2 Decorative Effects in Skins

With positive forming it is difficult to avoid grain loss over sharp corners (e.g., instrument cluster eyebrow). It is also difficult to incorporate decorative effects. Negative skin forming (e.g., drawing down into a negative mold cavity rather than over a positive mold) allows the incorporation of logos and emblems into the skin to both achieve product differentiation but also assembly cost savings. It is also possible to incorporate features such as heating, ventilation, and air conditioning (HVAC) vent doors. Negative forming has higher tooling costs than positive forming, but this is easily offset by the surface quality, decorative capabilities, and the potential for cost savings through in-line forming of the instrument panel.

### 5.3 Color

Black, brown, and dark colors have long dominated interior surfaces. Recent trends have been toward lighter colors. Two-color instrument panels began in the early 1990s. (Renault Megane was an early example.) In Europe, a trend toward pastel colors appears to be emerging for instrument panels skins.

### 5.4 Pattern

With the development of niche vehicles targeted at a younger buyer, there are initial signs of a trend toward printed patterns on skin surfaces and the coordination of patterns between instrument panel, door trim, flooring, and seating. The

utilization of highly patterned seating began in the European market in the mid-1990s. This trend has accompanied the growth of TPO skins on several modules (IP, DT, floor). The development of patterns on polyolefins is notable due to the difficulty of printing on these low energy surfaces. Coatings and surface modification (flame, adhesion promoters) as well as the development of special inks are facilitating printing on polyolefin substrates. Back printing of a surface laminate layer is the most commonly used method, but molded-in decorative effects, which are more cost effective, are likely to compete with printing when a specific pattern is not required.

### 5.5 Molded-in Decorative Effects

Molded-in decorative effects are commonly used in thermoset moldings (e.g., boats, spas, eyeglass frames). Recently molded-in speckle and fiber decorative effects have been molded into thermoplastics for appliances and housewares. These rely upon dispersed particles (flake, metallized films, fibers) to provide the decorative effect. Techniques to maximize concentration of the decorative material near the surface and to control the dispersion have been facilitated by the improvement of injection molding process control systems. The application of decorative effects to a broader range of auto interior surfaces is encouraging the evaluation of molded-in decorative effects, especially in noncarpet, TPO flooring where more randomized designs are acceptable.

## 6 IN-MOLD DECORATION

### 6.1 Definitions

It is important to note the difference between:

- Molded-in decoration (e.g., decoratives dispersed in the body of molded [as well as extruded or calendered] parts), and
- In-mold decoration that relies on a surface film (coextruded or back-printed).

### 6.2 Current Status

In-mold decoration is commonly used in the automotive sector to achieve special effects (wood grain, brushed metal look, etc.) on interiors and exteriors. The dominant incumbent is laminated film in which the decorative effects are back printed behind the surface layer. Typically, these films are thermoformed off-line and placed in an injection or compression mold that is subsequently filled with molten substrate polymer.

### 6.3 Coextruded Films

Coextruded, multilayer films to achieve surface decorative effects and provide surface weathering resistance are well established in the appliance, recreational vehicle, and pool/spa industry.

Recently, coextruded films have been applied to automotive surfaces (e.g., MY 2002 DaimlerChrysler Neon and the Smart Car) for bumper fascia and roof surfaces. This construction to be used is evolving but is likely to consist of a five-layer structure of surface film/adhesive/color layer/adhesive/thin sheet (TPO or HDPE). The thin sheet layer is designed to adhere to the injected layer. An extruded layer may be substituted for the injected layer in applications in which the entire structure is thermoformed (e.g., adaptation of major appliance and pool/spa fabrication methods).

The initial constructions appear to be capable of offering fabrication cost savings over painted parts such as bumper fascia, but it is too early for a definitive economic comparison due to the uncertainties of scrap rate, cycle time effects, ability to match metallic colors (on painted metal surfaces), etc.

## 7 SUMMARY

Coatings for polymer substrates offer the automotive OEM a broadened range of protective, decorative, and tactile capabilities that will develop with the following trends:

### 7.1 Liquid vs. Alternative Coatings

Liquid coatings on hard surfaces will come under increasing pressure from:

- In-mold decoration (based on coextruded films and back-printed films);
- Molded-in decorative effects; and
- OEM objectives to eliminate coatings from hard and soft interior surfaces where possible.

### 7.2 Skins

The invisible airbag door will continue to be a key IP skin driver. Slush molding and spray PU will continue to gain share versus vacuum forming. Spray PU will show the greatest short-term gains. If TPO slush compounds are developed that are capable of meeting scratch resistance requirements and are capable of being used without coatings, they could see share gains. Skins capable of being used in in-line processes will be preferred. A utilitarian look will gain share for IP skins and other above-the-belt-line applications.

### 7.3 Floor Systems/Acoustic Barriers

Noncarpet flooring surfaces, probably based on TPO, will grow in the market, accompanied by lightweight acoustic substrate layers capable of achieving tunable acoustic properties while saving weight. New printing technology will allow patterned floor surfaces, probably coordinated with other interior surface patterns. Molded-in decorative effects will enter the floor system using the non-carpet skin. For carpeted floor systems, PP face yarns will gain share in the North American market, further facilitating the all-polyolefins carpet system.

### 7.4 Body/Glazing Seals

The TPEs can be expected to continue their growth in this high-volume market based on the desire for color and the potential for systems cost savings. The coatings on rubber are being adapted to provide adhesion, control surface friction, UV protection, and gloss.

### 7.5 Coated Fabrics

The TPOs have begun penetration of this key PVC interiors sector in Europe and North America. Severe price competition and the current, unfavorable economic conditions are likely to delay this penetration.

## ACRONYMS AND DEFINITIONS

|            |   |
|------------|---|
| DT         | door trim panel   |
| EMI        | electromagnetic induction   |
| ESI        | ethylene styrene interpolymer   |
| Haptik     | German for touch or feel of an interior surface   |
| HVAC       | heating, ventilation, and air conditioning  |
| IMC        | in-mold coating   |
| IP         | instrument panel  |
| MIC        | molded-in color   |
| MY         | model year  |
| NVH        | noise, vibration, harshness (performance driver for interiors)  |
| OEM        | original equipment manufacturer (e.g., the automaker)   |
| RF         | radio frequency   |
| TF         | thermoforming   |
| TPE        | thermoplastic elastomer   |
| UEV        | unsupported expanded vinyl  |
| Zweiglänze | coatings that provide a three-dimensional appearance by differentially altering the peaks and valleys of grained surfaces (usually on interior skins) |

**REFERENCES**

1. Automotive interior soft trim in the U.S. and Europe. Multiclient Study, Robert Eller Associates, Inc., 2002.
2. <http://www.alfaromeo.com>, Sept. 2001.
3. A Giboreau, A Bardot. L'évaluation sensorielle tactile des matières plastiques. Le Havre, France: JEMA, February 2, 2000.
4. D Nesa, S Couderic, S Crochmore. Matériaux d'habitacle automobile et approche sensorielle. Le Mans, France: Comfort Automobile et Ferroviaire, November 15, 2000.
5. R Eller. Growth opportunities for TPOs in auto interior skins, foams, and acoustic barriers. SPE Automotive TPO Global Conference, Detroit, MI: October 2000.
6. SEBS, TPV, and TPO-type thermoplastic elastomers . . . markets, economics, technology, intermaterials competition and the role of metallocene resins. Multiclient Study, Robert Eller Associates, Inc., 2000.
7. R Eller. TPE intermaterials competition in auto interiors in north america and Europe. SPE Automotive TPO Global Conference, Detroit, MI: October 2001.
8. R Eller. Acoustic barriers—material substitution and industry structure drivers. Automotive and Transportation Interiors, 46, November 1999.
9. R Miel. Plastics News August 13, 2001, p 1.
10. European Instrument Panel Photo/Supplier Database, Multiclient Study, Robert Eller Associates, Inc., 2001.
11. Automotive interior skins and foams . . . intermaterials competition, technology and global markets. Multiclient Study, Robert Eller Associates, Inc., 1998.
12. R Eller. Automotive interiors . . . impact of new fabrication technology and materials. Le Havre, France: JEMA, February 2, 2000.
13. R Eller. Polypropylene usage in auto interior textile applications. The PP Technology Conference, Clemson University, August 1998.
14. Elastomères Thermoplastiques . . . a l'interface de caoutchouc. SNCP Meeting, Paris, June 21, 2000.



# 10

## Automotive Plastic Coatings in Europe

**Hans Christian Gruner**

DuPont Performance Coatings, Cologne, Germany

**Klaus-Werner Reinhart**

DuPont Performance Coatings, Wuppertal, Germany

### 1 INTRODUCTION

In Europe, the coating of automotive plastic components began in the early 1980s with exterior trim applications and started with highly-priced vehicles. In these initial applications, rigid reaction injection molded (RRIM) and polycarbonate (PC) blended bumpers and side claddings were coated with the same color paint used on the body of the vehicle. In addition, some design stylists chose to contrast the color for aesthetic reasons in order to differentiate their models. However, in both these applications, the function of the coating was to provide aesthetics and to protect the plastic from aggressive sunlight and chemical agents. As time progressed, the occurrence of painted bumpers became more common, especially thermoplastic polyolefin (TPO) bumpers for lower-priced, middle-class vehicles. Coated plastic parts were introduced to meet both the design standards and the long-term durability requirements desired by the original equipment manufacturers (OEM). The use of coated plastic parts increased even further and began to include components in nonimpact areas like mirror housings or grills, where acrylonitrile-butadiene-styrene (ABS) plastic dominated and was coated in contrast or body color. Today, almost every vehicle in Europe, even the lower-priced models, has coated exterior plastic components.

Coated interior plastic components are also very prevalent and were widely introduced in the 1990s. Automotive stylists use various techniques to design the car interior and more and more coated plastics play an important

role. The use of plastic components has also been observed as a substitute for metal in body applications like wings, fenders, and tailgates. Both off-line coating and on-line coating techniques are used to coat this type of small parts.

While some car companies have built their own bumper coating lines or even injection molding lines, more than 80 percent of the coated plastic components are provided suppliers and most of these do both jobs molding and coating to deliver complete assembled components to the automotive industry.

The European market volume for coatings for automotive plastic components is in the range of 50,000 tons for the year of 2000 (Fig. 1) and is expected to reach 60,000 tons by 2004 (1).

## 2 CHARACTERISTICS OF THE PLASTIC COATINGS PROCESS

A typical bumper fascia plant in Europe has a capacity of about 3,000 bumpers per day. The plant is comprised of robotized spray booths for primer, basecoat, and clearcoat, and includes an 80°C oven (Fig. 2). Optional elements found in some plants include power wash, a pretreatment unit, and a primer oven.

For optimum appearance and part quality, the bumpers are positioned on an under floor conveyor skid in the position equal to the assembling of the car body (Fig. 3). This is done in order to avoid any color deviation (azimuth) between the plastic part and the car body. The conveyor speed is 2–3.5m/min (6–11.5 ft/min) and skids are loaded with 2–6 parts parallel to the conveyor direction.

Most paint spray booths are configured for two robots, with both on one side of the conveyor line or staggered opposite each other, depending on the part positioning on the skid. The paint is atomized when sprayed through pneu-

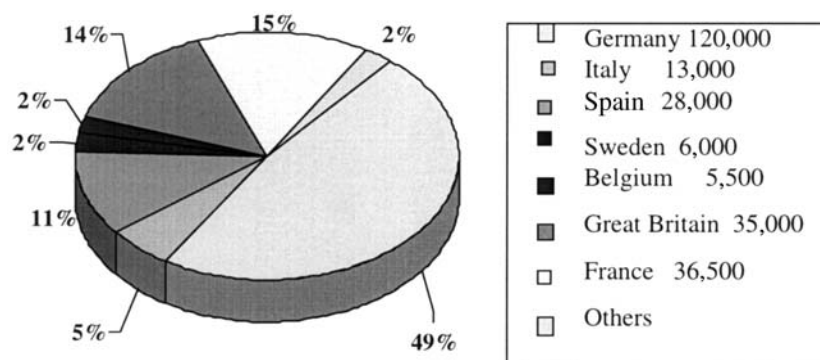

FIG. 1 Coatings for automotive exterior plastics: overall paint sales in the Year 2000 in European countries.

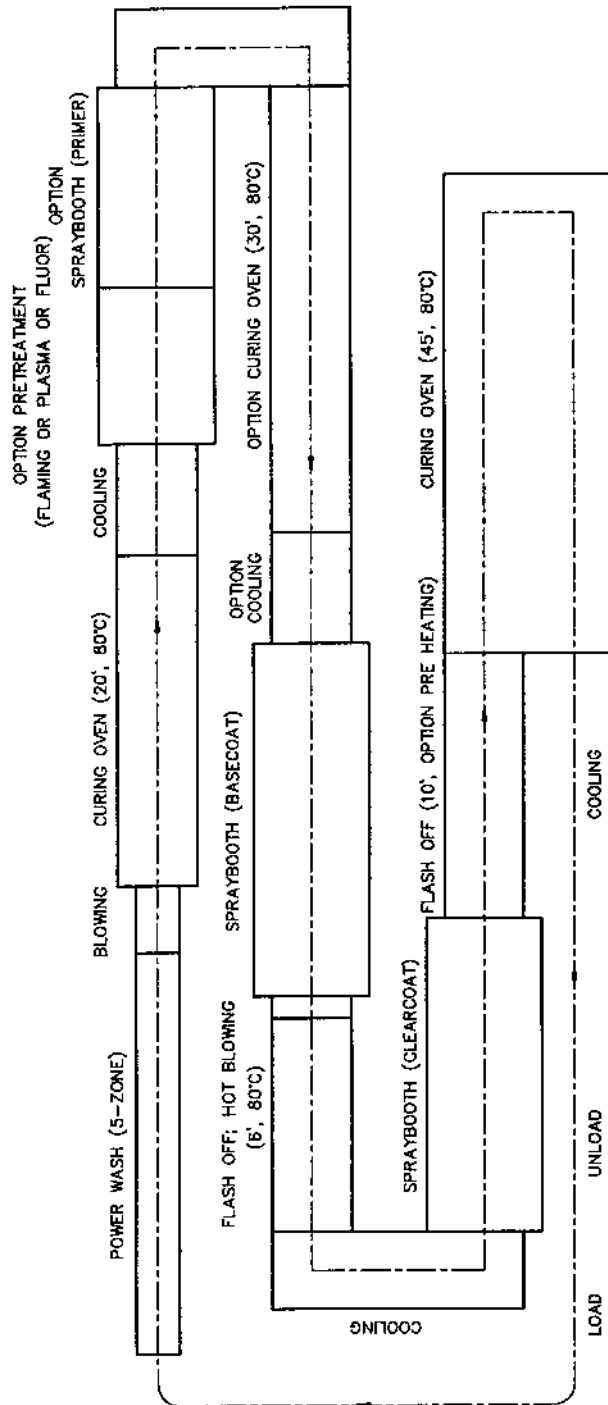

Fig. 2 Process steps in bumper coating plants.

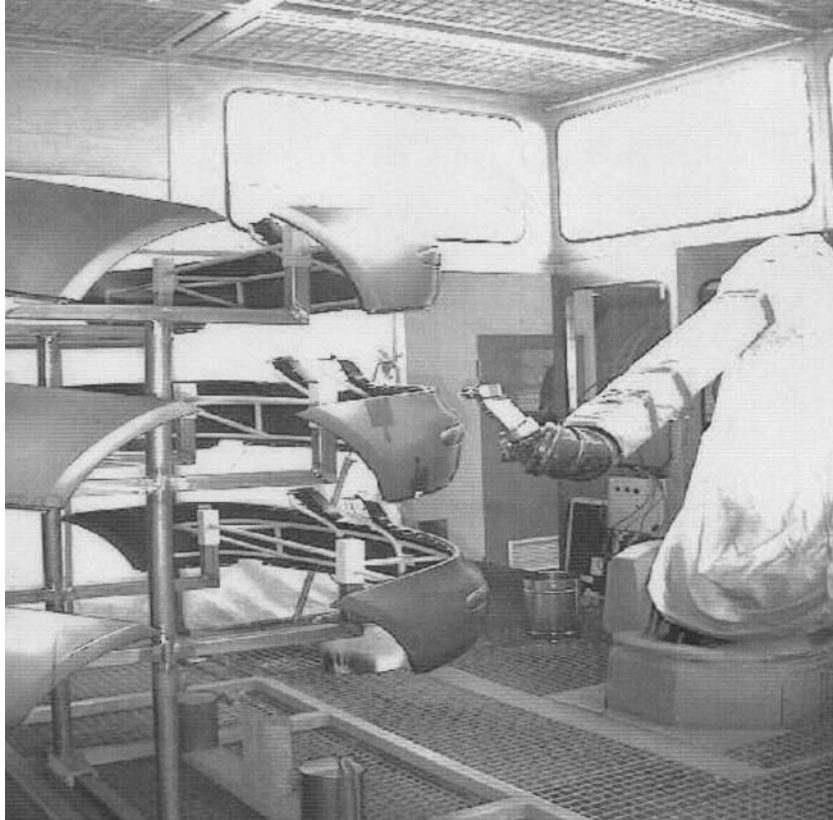

FIG. 3 Bumper coating robotic process.

matic guns or through electrostatic high rotation bells. Although limited, some coaters still apply paint through handheld guns.

In France and south Europe, a complete wet-on-wet process consisting of primer, basecoat, and clearcoat is quite popular and is used in conjunction with a final 80°C oven. In Germany, the primer is baked at 80°C in which the primer oven is typically integrated. Low temperatures around 80°C are used to cure the paint and avoid distorting the part. Higher oven temperatures would result in significant part distortion. Unlike that used in North America, high curing temperatures (121°C) are only used to cure plastic parts with high dimensional stability, like sheet molding compound (SMC) or thermoplastics such as General Electric's Noryl GTX.

Due to the low paint curing temperatures for thermoplastic automotive molded parts, two component or two pack clearcoats are typically used. All the paint used needs to provide sufficient flexibility to ensure high-impact performance of the molded part even at low temperature (2). If a clearcoat is highly flexible and exhibits a hard surface to easily polish defects caused by coating impurities, it has attributes that empirically appear to contradict one another. However, through today's advanced resin chemistry, products are available that offer both ambient temperature polishing capability and excellent flexibility, as measured through low-temperature impact.

## 2.1 Ecological Considerations

In addition to cost reduction and higher quality standards (wave scan, color matching), the main driving force for innovation has been and continues to be ecology. Until the late 1990s, most coating materials for automotive plastic components continue to be solvent based. This is quite surprising given that water-based basecoats for plastics were introduced as early as 1985, and water-based basecoats clearly dominate on the car body. The reason for the slow progress in plastic coatings was that legislation focused on newly built plants and implemented more stringent ecological standards on these plants. The plants for painting plastic parts were much older, and in some cases, less sophisticated.

As an example, the German "TA Luft" regulation of 1986 limits the solvent concentration to 150 mg/m<sup>3</sup> for automated spraybooths and 50 mg/m<sup>3</sup> for oven exhaust. To meet this limitation, two paths were used. Firstly, by recirculating the spraybooth air, volatile solvents could be concentrated while being continuously extracted and a percentage cleaned using thermal incineration equipment. Secondly, water-based materials could be used to reduce solvent emission and pollution. Unlike in the continental countries, beginning in the early 1990s Great Britain adopted legislation similar to that of the North American regulations comprising of a volatile organic compounds (VOC) concept for all paint materials.

In order to harmonize the regulations for solvent emission in the European Union (EU) member countries and to enhance ecologically friendly coatings in both new and existing plants, the EU states have agreed to a regulation currently in force. This "Council Directive 1999/13/EC" of March 1999 is based on the limitation of emissions of VOC due to the use of organic solvents in certain activities and installations (3). From this legislation, a great reduction in VOC through the period 2004 to 2007 is expected. This regulation states that the solvent concentration for plants using more than 15 tons/annum of solvents is limited to 75 mg C/m<sup>3</sup> in the EU with a lower level of 50 mg C/m<sup>3</sup> being allowed in Germany. If this is not achievable at that point in time, a reduction plan can be approved by the authority, according to the EU guidance document

titled "IPPC-Integrated Pollution Prevention and Control." It is remarkable that all activities are supported that apply best available techniques (BAT). Although the EU regulation does not set solvent limits per unit of paint material, single EU members allow for compliance of the regulation by meeting VOC limits. For example, in Germany, the general limit is 250g/l, although higher values may be set for specific applications (4,5).

### 3 COATING OF TPO BUMPERS/FASCIA

When coated bumpers were introduced by the European automotive industry in the early 1980s, compounds of polypropylene homopolymer (PP) with thermoplastic ethylene-propylene rubber (EPR), or ethylene-propylene-diene rubber (EPDM) dominated (6). Using highly specific metallocene catalysts, it was found possible to polymerize PP in an isotactical structure with the required molecular weight. The function of the rubber phase (post blended, post extruded) was to improve low-temperature impact resistance but in addition to this it was effective to improve paint adhesion and allowed for a coating without pretreatment. The EPR phase is embedded in the continuous PP phase in form of spheric domains and disorted (elongated) inclusions near to the molding surface.

Due to cost reduction needs of late, these blends have been substituted by reactor blends using stepwise propylene- and ethylene-propylene copolymerization techniques in the gas phase. Thus the rubber elastifier is introduced in a low-cost one-step process. Rubber contents as high as 50 percent can be provided. It was quickly seen that TPO produced by this manufacturing method gave more problems with paint adhesion than that seen in traditional PP-EPDM compounds.

In France and Italy, very often copolymers of propylene and ethylene are used. These materials are characterized by a homogeneous phase character without any distinct rubber phase. Therefore, complete and accurate pretreatment is crucial to get the expected adhesion with these materials. When higher stiffness and temperature resistance is required, high modulus TPOs with 10 percent or more of talc extender is quite common for bumpers. The added talc has the additional benefit of enhancing adhesion of the coating to the plastic.

Due to the thermal properties of the TPO and the thin-walled molding that very often is as low as 2.5 mm, the temperature limit for paint curing is 90°C (194°F) provided the part is fully supported on the painting skid. Typically, therefore two component primers and clearcoats are used along with one component basecoats.

Attention has to be paid to the variable degree of crystallinity of the PP phase that depends on the polymer (stereo regularity), the blend formula, and

**TABLE 1** Examples of TPO Moldings/Related to the Coating Process for a Reactor-Blend and a Reinforced Compound

|                               |                             |                            |
|-------------------------------|-----------------------------|----------------------------|
| MFI (ISO 1133)                | 7 g/10 min                  | 4 g/10 min                 |
| Reinforcing compound          | 0                           | 10–20% talc                |
| E-modulus/blend               | 900 Mpa                     | >1200 Mpa                  |
| Shrinkage (mold plus coating) | 1.8%                        | 0.9%                       |
| Thermal elongation            | 125 $\mu\text{m}/\text{mK}$ | 60 $\mu\text{m}/\text{mK}$ |
| Surface tension (not flamed)  | 25–30 dynes/cm              | 25/30 dynes/cm             |

Source: Refs. 6 and 7.

the molding conditions (speed of cooling). This affects both shrinkage properties and adhesion of coatings. Shrinkage, depending on filler load, takes place not only in the molding process but also to a certain degree in the thermal steps of the painting process. This is to be considered in automotive “no gap” body applications. Also important for no-gap applications is the thermal elongation coefficient that ranges from 60 $\mu\text{m}/\text{mK}$  to 120 $\mu\text{m}/\text{mK}$  for reinforced and nonreinforced TPOs respectively. With respect to the coating properties, high crystallinity negatively influences paint adhesion.

New highly crystalline, higher modulus (HCPP) TPO grades have been developed without the need for a high filler loading and without the need for a compounding step. In the past, high modulus TPO has been widely achieved through obtaining the desired specific gravity and by compounding the polymer with inorganic extenders. In the future, HCPP grades will be more commonly offered in the marketplace.

To broaden the area of TPO applications to the low modulus side offering plastics with elastomeric properties, compounds with both a thermoplastic PP matrix and vulcanized domains of ethylene butylene rubber (EBR) have been introduced. These offer a route to rubber-like materials that can easily be produced through injection molding. As a special feature, these thermoplastic elastomers (TPE) can be sequentially co-injected with “normal” TPO to give parts with specific functional zones.

### 3.1 The Coating Process for TPO Moldings

In some cases, the parts are coated without going through a washing process as they come out of the injection-molding machine. This is fairly rare as most parts pass through a four-phase aqueous power wash and a dryer. After cleaning, usually a pretreatment step follows to ensure paint adhesion before the painting process of primer, basecoat, and clearcoat is applied.

**TABLE 2** Pretreatment Methods for Automotive TPO Moldings

---

|                               |
|-------------------------------|
| Flaming                       |
| Low-pressure plasma treatment |
| Corona treatment              |
| UV-primers/UV-treatment       |
| Fluorine treatment            |

---

#### 4 PRETREATMENT

Until the 1990s, TPO parts were often coated without any chemical pretreatment using “no flame primers.” However, this has changed since trends to reactor TPO technology and more demanding specification tests have been implemented. Today, nearly all of the TPO bumpers coated in Europe are pretreated.

##### 4.1 Flame Treatment

The dominating chemical pretreatment used in Europe for molded automotive TPO components is flame treatment. The effectiveness of the flame treatment is checked by surface tension measurement and should be a minimum of 45 dynes/cm to ensure acceptable adhesion with solvent-based paints. Chemically, the adhesion effect of flaming is based on a controlled oxidization of the CH<sub>2</sub>- and CH<sub>3</sub> units (7). Also, a degradation of the polymer and polymer melting can occur; therefore the flaming needs to be carried out within an upper and lower temperature limit.

Mostly flaming booths are robotized and integrated in the conveyor line. While simply shaped parts get good overall treatment and can be coated even with standard plastic primers, other parts, due to their complex three-dimen-

**TABLE 3** Flame Pretreatment/Chemical Effects

---

| Surface-tension<br>(polar/dispersive)<br>dynes/cm | Atom—<br>% Oxygen | Adhesion                    | Remarks                   |
|---|-------------------|-----------------------------|---------------------------|
| 25–29 dynes/cm                                    | 1%                | None                        | Unflamed TPO              |
| 36 (15/21) dynes/cm                               | 8–9%              | Borderline (mostly weak)    |                           |
| 45 dynes/cm                                       | 12–16%            | Good (solvent-based paints) |                           |
| 55–75 dynes/cm                                    | >16%              | Good (water-based paints)   |                           |
| 55–75 dynes/cm                                    | >16%              | Peel off paint/degraded TPO | Overflame,<br>TPO melting |

---

Source: Ref. 8.



**TABLE 4** Flame Pretreatment/Examples of Flaming Parameters

|                                |  |
|--------------------------------|--|
| Excess of oxygen               | For air: propane 26:1 by volume                          |
| Flame speed                    | 300–600 mm   |
| Burner distance to TPO surface | 100 mm (at flame size 100 mm)                            |
| Overlapping                    | Maximum of 3   |
| Processing remarks             | Coat within 2 hours (on some TPOs flaming does not last) |

*Source:* Refs. 6 and 8.

sional geometry, cannot be sufficiently treated. Typical defects are poor paint adhesion, for example, on bumpers in lamp-openings or grille areas due to deviations in positioning of the skids to the flaming robot. Therefore, for optimum results, most painters often combine flaming with use of an adhesion-promoting primer (usually chlorinated polyolefin). Once the process is established by pre-trials and testing, the flame treatment provides optimum adhesion to meet even the toughest specifications and the primer ensures good adhesion for performance in practical use even on zones not treated properly.

#### 4.2 Low-Pressure Plasma

In some cases, in Europe automotive components are pretreated by low-pressure plasma. As this process is more costly than flame treatment, it is used less frequently. However, it is an attractive process for flaming complex parts that cannot be effectively treated due to their size, shape, or the presence of recessed areas. The more consistent plasma process can alter the surface of the entire part and often allows the application of topcoat direct, without the use of and cost associated with a primer. Various systems are offered for plasma treatment. They mainly differ in the high-frequency wavelength that is used to generate the plasma (10,11).

#### 4.3 Fluorine Treatment

In addition to flame treatment and low-pressure plasma treatment, fluorine treatment has gained some importance as an alternative method (12). This method is very effective and even gives excellent results on polyethylene or polypropylene homopolymer even when flaming does not provide sufficient adhesion. Many automotive parts such as interior door handles and interior switches have been successfully treated by this method. For the fluorination process to work effectively, the parts need to be positioned in a reactor to which a vacuum is applied. After approximately 20 seconds or so, the parts are exposed to 10 percent fluorine gas in air at 500 mbar (7.0 psi) pressure. The excess of fluorine and the

by-product of hydrogen-fluoride (HF) are pumped to an absorber column of lime and fluorinated compounds are trapped. As a result in a closed cycle, calcium fluoride, the raw material from which the fluorine is manufactured is regenerated and reformed (Fig. 4).

In chemical terms, the principle of the fluorine pretreatment method is based on the controlled formation of C-F groups on the TPO surface. By controlling the fluorine concentration, the pressure and the treatment time, a highly defined and effective process can be established as shown in Figure 5.

Particularly small items, some of which can be flamed only with difficulties, can be easily treated in the fluorine reactor by using a cylinder filled with the parts that is rotating during the fluorine exposure.

#### 4.4 Other Pretreatment Methods

Methods such as corona treatment have not been very common for three-dimensional moldings in Europe due to the difficulties to control parameters like distance of the corona electrode to the surface to be treated. However, simply shaped parts like side protection moldings have been effectively treated prior to coating using the corona discharge method. A variation of the improved method is known as "Ambient Pressure Plasma" (Plasma Gun) (13). Ultraviolet (UV) primers have been used in France and Italy combining the adhesion effect of adhesion promoters with the attack of free radicals formed under UV irradiation to the polymer (14).

The chemical pretreatment methods mentioned are mostly used for TPOs, but in some cases can also be effective when used on polyamide (PA), polybutylene terephthalate (PBT), or other crystalline polymers, as well as some blends like poly(phenylene oxide)/polyamide (PPO/PA), are flamed. As a possible future trend, research is currently underway (plasma polymerization) attempting to combine a pretreatment for adhesion and to provide the surface conductivity on necessary on plastic parts for acceptable electrostatic application (15).

## 5 PRIMERS FOR TPO COMPONENTS

In the early 1980s, adhesion promoters based on chlorinated polyolefins (CPO) were frequently used on many types of automotive components including bumpers to be coated in body color or in a low-gloss black finish. Shortly after, however, these chlorinated adhesion promoters were substituted with light-gray two-component (2K) primers. These primers, in addition to providing coverage of black TPO materials, gave better performance in difficult and severe tests that were being developed and implemented by OEM customers (7). The principle of these 2K primers is to combine a resin that is able to be crosslinked with a CPO. Both act synergistically to enhance adhesion on TPO substrates. The



**FIG. 4** Exhaust gas absorption unit for fluorine pretreatment of plastic parts. (Courtesy of Fluor Technik System GmbH, Lauterbach, Germany.)

**TABLE 5** Chemical Reactions in Fluorine Treatment

|                              |     |  |                             |
|------------------------------|-----|--|-----------------------------|
| $=\text{CH}_2 + \text{F}_2$  | $>$ | $=\text{CHF} + \text{HF}$                            | (Surface treatment step)    |
| $2\text{HF} + \text{CaCO}_3$ | $>$ | $\text{CaF}_2 + \text{H}_2\text{O} + \text{CO}_2$    | (Absorption of exhaust gas) |
| $\text{F}_2 + \text{CaCO}_3$ | $>$ | $\text{CaF}_2 + \frac{1}{2}\text{O}_2 + \text{CO}_2$ | (Absorption of exhaust gas) |

crosslinking mechanism involves the reaction of either amine or hydroxyl functional groups with epoxy or isocyanate hardeners, respectively.

For electrically conductive primers, conductive carbon black and graphite are used as the conductive pigments. To give at least a dark gray color, just the amount of titanium dioxide white pigment is used to maintain a surface resistance of about 20 k-ohm/cm. Unfortunately, the result leaves something to be desired. Therefore, alternative conductive paint ingredients have been developed and commercialized and today medium to light gray primers are available using conductive pigments based on antimony-doped stannous oxide layers (16). However, the very high cost of these conductive pigments has restricted their growth dramatically.

When coating TPO in Europe, usually a combination of some type of pretreatment plus 2K adhesion primers are used. The pretreatment provides optimum adhesion to even pass hot-water jet tests in which scribed painted parts are exposed to 100 percent relative humidity for ten days at 40°C before being

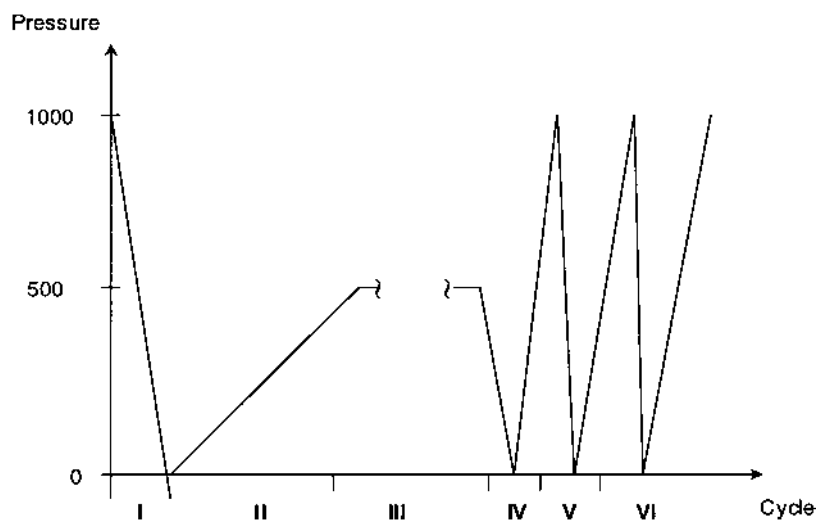

**FIG. 5** Process control of fluorine treatment. Pressure Unit 1000mbar = 14.7 psi, Stage I: Evacuation, Stage II: Inlet Fluorine, Stage III: Treatment, and Stages IV, V, VI: Flushing. (Courtesy of: Fluor Technik GmbH, Lauterbach, Germany.)

blasted with hot water. The role of the primer is to provide adhesion in any areas that may be insufficiently flamed due to wrong positioning of skids to the robots. Failures caused by this, for example, on lamp openings and grille areas of bumpers can be prevented by this dual "belt and suspender" strategy.

Significant progress has been made to develop primerless coatings for TPO bumpers using additives that make the basecoat adhere directly to the plastic surface (17,18) without the need for chlorinated adhesion promoters. Using statical mixing equipment, the additives are mixed in the basecoats for paint being applied through the first robot. A second spray of basecoat is carried out with the conventional basecoat not containing the additives. This formulation technique and application process offers a considerable cost-saving opportunity because a layer of chlorinated primer is eliminated. An unexpected benefit of this additive approach was a smoother topcoat appearance (less orange peel) due to superior basecoat wetting of the TPO substrate.

Waterbased primers have been introduced to reduce solvent output from TPO component coatings in Europe. As these do not contain efficient adhesion-promoting ingredients for TPO substrates, the result is strictly dependent on the chemical pretreatment. Commercial experience with these waterbased products has been limited to polypropylene surfaces that have been perfectly flamed and thus the scope of this technology at present is limited to relatively simply shaped parts. New experimental primers with inherent adhesion to TPO are under evaluation and will allow for substitution of their solventbased counterparts in the very near future.

Some degree of flexibility must be built into these primers because after topcoating with conventional basecoat and clearcoat, the flexible clearcoat systems have to pass the low-temperature impact resistance required for automotive bumper fascias and other components in the impact area of the vehicle.

## **6 COATING OF POLYCARBONATE AND SOLVENT-SENSITIVE PLASTICS**

A number of plastics used for automotive exterior components have many properties in common with regard to coating due to their amorphous structure and their polar nature. A very important issue with these materials is a more or less pronounced solvent sensitivity. The origin of this is inherent stress from the molding process. Coatings with aggressive solvents can penetrate into these plastics causing the plastic to swell (19). Stress can be relieved giving rise to stress cracking. This is one mechanism of deteriorating the impact properties of amorphous plastics and the coating formulator needs to choose all solvents carefully.

The use of polycarbonate in Europe for automotive component applications like bumpers or grilles, is modified with a high percentage of PBT, a partly crystalline polymer. Often, the PBT is the major component of the blend.

In that case, the properties of the PC, for example, solvent sensitivity, are not very pronounced but those of PBT have to be regarded. Careful primer selection is needed to provide good adhesion. In addition, PC is prone to a base-catalysed hydrolysis that can cause paint loss, especially after field exposure. Basic ingredients that can migrate into the PC need to be examined for this type of potential field failure. Notwithstanding, PC/PBT blends are used in similar applications as TPO namely for bumpers and grilles. For improved impact resistance on bumpers, an elastomeric modification is crucial. As the price of PC blends is greater than that of TPO, PC blends are predominantly used on high-end vehicle bumpers where in some cases, higher thermal stability is required.

Polycarbonate primers in Europe are 2K-isocyanate curing or 1K-nonreactive products based on fairly flexible linear polyurethane or polyester resins. Thus the low glass transition temperature ( $T_g$ ) of these flexible resins maintains the low-temperature impact resistance of the plastic. This resin selection is in addition to the proper solvent selection. In general, PC painting is not considered difficult when the coatings are formulated consistent with that discussed previously.

All automotive components that will be used in areas subject to potential vehicle impact require topcoats that involve highly flexible clearcoats. This is needed to avoid a drastic reduction of energy absorption upon impact. In instrumented impact tests, elastomeric-modified PC blends perform giving excellent results as high as 100 Nm at 23°C and show very little loss down to 40°C. If the specific requirement for the coated part is, for example, that the performance shall be more or less maintained without any brittle failure at -20°C, the flexible nature of the clearcoat can be adjusted accordingly using the instrumented impact method (2). More often however, the performance specification is defined according to the OEM requirement for a complete bumper system.

Now ABS is widely used for decorative components outside the impact area of the vehicle, for example, for mirror houses, grilles and many others. Because ABS has some limiting thermal and mechanical properties, often a blend of ABS/PC can offer a higher performance alternative than straight ABS. Again, primers (if used) need to be fairly mild to prevent the formation of finish defects that can originate from the molding process like weld lines or flow marks. Sometimes ABS parts are painted without primer using a mild diluent for the basecoats. The 2K waterbased primers also are suitable as mild water miscible cosolvents are well available and can be quite effective.

### 6.1 Other Plastics for Exterior Components

Thermoplastic polyesters PBT and poly(ethylene terephthalate) (PET) are not widely used for exterior automotive components. However, certain grades of PBT and PET that are reinforced with glass fibers are used for parts such as fuel flaps that are coated off line.

Polyamide is used for automotive components that have high requirements for their thermal, chemical, and mechanical resistance. Often glass fiber-reinforced grades are used to obtain even higher performance. The polymer variations and the compound formula offers a wide variety of product for the plastics engineer to design. To be considered when coating PA, is both the tendency of forming localized crystalline structures on molding that can result in localized adhesion failure and a relatively high degree of water absorption. Only a few known paint resins can offer good adhesion to PA. In some cases, standard primers are used even after flame pretreatment in order to assume strong adhesion.

Blends of PA with polyphenylenoxide (PPO) have properties very similar to pure PA. Like all crystalline plastics, they exhibit not only molding shrinkage but also “painting shrinkage” due to thermal steps in paint process. The major use of PA and PA/PPO blends is in automotive body application (see Section 7). As on-line coating is quite common for these types of parts and involves fairly high temperatures, plastic shrinkage is a major concern and needs to be considered carefully. The part conductivity of the molded component for the “on-line coating” is provided by conductive primers. As an alternative, PPO blends can be pigmented electrically conductive pigments and thus can be electrostatically topcoated without the need for a conductive primer (20). This technology is used for both “off-line” coating and “on-line” topcoating of wings, tailgates, and the like.

The use of plasticized poly(vinylchloride) (PVC) has been widely eliminated in the European automotive industry. When PVC needs to be coated, special primers can be used to control any migration of the plasticizer.

An interesting technology is the use of pigmented PC blends. The molded parts are coated with a special clearcoat to protect the polymer from aggressive chemicals and UV-light, and help improve the scratch resistance (21).

## 7 TOPCOAT TECHNOLOGY DESCRIPTION

Due to the ecological and low bake requirements for plastics being coated in Europe, both solventborne and waterborne basecoats are used in conjunction with a low-bake, 80°C, 2K isocyanate clearcoat. Descriptions of these technologies will be discussed in relation to the influential European drivers.

### 7.1 Solventborne Basecoats

Automotive styling in Europe greatly favors traditional high flip-flop aluminum or mica effects. This limits the potential use of typical North American high solids coatings that exhibit a smaller degree of metallic flop. Typical basecoats for coating plastic in Europe are one component type, and are usually based on

polyester resin and contain cellulose acetate butyrate (CAB) for rheology control and the high degree of metallic flop. In certain cases, linear polyurethane resins can be used as the main resin backbone or as a co-resin in order to give the coated part the required impact resistance. However, there is some use of higher solids materials based on microgel technology with a solid content (by weight) that seldom exceeds 30 percent.

The typical application method for metallic basecoats in Europe to get the high amount of high flip-flop involves a two-step application. The first step is applied using high rotation bells and applies approximately 60 percent of the film. After a short intermediate flash off, a second coat follows that delivers the remaining 40 percent through pneumatic atomization. This process is also used for solid colors with a clearcoat being applied after a short ambient flash.

Exact color matching is crucial and constantly is the major issue for all suppliers of plastic parts coated in body color. On most vehicles, there is no gap between the automobile body and the painted plastic part. These “no gap bumper design” parts, plastic fuel flaps, and other parts highly integrated in the body design are highly demanding for both paint formulation and application technology. Therefore, in Europe typically, basecoats are individually formulated and supplied to color match the part to the body when applied by the plastic parts painter according to their painting process (22).

There have been attempts to apply basecoats totally by electrostatic application. This has not been totally successful. However, it is only possible when all three, the car body, the master panel, and the plastic part, are coated using the exact same application technique. As an example, DaimlerChrysler in Rastatt/Germany started to apply basecoat for the “A-Klasse bodies” completely using a bell application and the supplier needed to introduce the same bell application for the final basecoat layer to achieve the required color match.

## 7.2 Waterborne Basecoats

Although some suppliers of coated components have been using waterbased basecoats for many years already, the new EU regulation is expected to be a major driving force for the further introduction of waterbased basecoats. In order to manage the introduction of waterbased basecoats for plastic parts, the majority of the automotive industry has introduced the twin concept for newly designed colors. Starting with a basic styling idea, the paint industry is requested to develop twin formulas, one that is waterbased and one that is solventbased. During this phase, the styling idea is modified in cooperation between the automotive stylists and the paint color experts, given that the scope of effects in waterbased and solventbased basecoats do not overlap completely. The procedure concludes with a color design that is feasible and can be produced and applied in both waterbased and solventbased formulations. In cases when this



procedure was not strictly followed (carry over colors from early design periods), color matching problems resulted especially when the body was coated using waterbased basecoats and the plastic parts were coated with solventbased basecoats. As a future trend, automotive stylists will use the full potential of waterbased colors regardless of the feasibility of matching in solventbased basecoat technology. This will bring additional incentive to convert all plastic coating basecoats to the water technology.

Very often, it is requested to use the exact waterborne basecoat on the plastic part that is used on the car body. One reason for this is the belief that a superior color match will be evident. However, there are two issues to consider with respect to this. Firstly, OEM waterbased basecoats are formulated using melamine resins that crosslink when curing the clearcoat at 130°C. In the case of plastic coatings, 2K clearcoats are used with lower oven temperatures of only 80°C. At this reduced temperature, chemical reaction cannot take place and some colors exhibit weakness humidity testing. Secondly, in many cases OEM basecoats don't match the master panel when applied on plastic parts due to dramatically different application conditions. Therefore a separate version of each color for plastic components is advisable. This then can be formulated differently (e.g., avoiding the extensive melamine cure needed) using more flexible resins and other formulation techniques. However, as to the need to use special plastic part basecoats or to use OEM basecoats, there are no general rules. Therefore, different routes are followed by many of the automotive companies and their suppliers.

Looking back to the early days with waterborne basecoats in Europe, all those involved with formulation and application had to learn about the specific characteristics of this new paint technology. Now this information has become accepted and commonplace, nearly all-new coating lines are designed to handle waterborne basecoat technology. Retrofitting solvent application equipment to handle waterbased paints is quite complex and involves setup of new lines. Modular integration capability above all is demanded in the process and application technology requirement profiles. Other major aspects are logistics, storage, shelf life, sufficient stable paint-stability in circulation, and dynamic viscosity curves for automatic dosing. In addition, an adequate wide application range for manual and automatic application with high-pressure air atomization and electrostatic high rotation is needed. Realistic climate ranges for application and evaporation, as well as practicable drying conditions with a sufficient spectrum in terms of heating curves and object temperatures are also necessary.

In order to achieve maximum paint utilization, special electrostatic, high-rotation (HR) sprays are increasingly being examined for their specific application potential, which in combination with the (highly conductive) waterborne paint systems also has a particular effect on the design of the entire paint supply system. The use of HR sprays for applying the basecoat is also being advanced

**TABLE 6** Design of Paint Supply Systems

|  | Solventborne basecoat                                  | Waterborne basecoat                                    |
|--|--|--|
| 1. Recommended temperature   | 23 ± 1°C (73 ± 2°F)                                    | 23 ± 1°C (73 ± 2°F)                                    |
| 2. Flow velocity for all systems (solid, metallic)                 | min. 0.30 m/s (1.00 ft/s)<br>max. 0.70 m/s (2.30 ft/s) | min. 0.15 m/s (0.50 ft/s)<br>max. 0.40 m/s (1.30 ft/s) |
| 3. Dynamic viscosity at 20°C (68°F)                                |  |  |
| solid  | 25–30 mPas   | 100–200 mPas   |
| metallic   | 25–30 mPas   | 80–160 mPas  |
| 4. Paint density (wet) at 20°C (68°F)                              |  |  |
| solid  | 1.00–1.20 g/cm <sup>3</sup><br>(8.35–10.00 lb/gal)     | 1.10–1.30 g/cm <sup>3</sup><br>(9.15–10.85 lb/gal)     |
| metallic   | 0.90–1.00 g/cm <sup>3</sup><br>(7.50–8.35 lb/gal)      | 1.02–1.03 g/cm <sup>3</sup><br>(8.50–8.60 lb/gal)      |
| 5. Useful life within supply system <sup>b</sup>                   |  |  |
| solid  | ≥2 months  | ≥2 months  |
| metallic   | ≈1 month   | ≈1 month   |
| 6.1 Filtration at supply   |  |  |
| solid  | 30–60 μm metal sieve                                   | 80 μm nylon filter bag                                 |
| metallic   | 40–50 μm vibration sieve                               | 80 μm filter bag                                       |
| 6.2 Filtration for first runnings (pressure filter, safety filter) |  |  |
| solid  | N/A  | N/A  |
| metallic   | N/A  | N/A  |
| 6.3 Filtration reflux (no pressure)                                |  |  |
| solid  | 50 μm filter bag                                       | 50 μm filter bag                                       |
| metallic   | 60–80 μm filter bag                                    | 80–120 μ filter bag                                    |
| 7.1 Materials for pipes and armatures                              |  |  |
| solid  | Steel + plastic  | Stainless steel + plastic <sup>c</sup>                 |
| metallic   | Steel + plastic  | Stainless steel + plastic <sup>c</sup>                 |
| 7.2 Materials for sealing, membranes, etc.                         |  |  |
| solid  | Plastic (PVDF, PTFE)                                   | Plastic (PVDF, PTFE)                                   |
| metallic   |  |  |

<sup>a</sup>Measured by means of HAAKE RS100 at  $\dot{\gamma} = 235 \text{ 1/s}$ .

<sup>b</sup>Data represent periods in which no visible change (e.g., greying of aluminum or color change) occurred.

<sup>c</sup>Stainless steels and synthetic materials according to table.

owing to the ever-increasing requirements being placed on color matching between the body and the plastic accessories. Low-pressure sprays (HVLP) are not generally used due to the somewhat higher viscosity of waterborne paint systems.

Material supply and preparation of ready-to-spray material involves the need for different techniques compared to solventbased paints. Water-thinnable paints should be transported and stored in a temperature range of between 5°C and 30°C, and absolutely frost free. As the specific heat of water is roughly twice that of organic solvents, it takes some time to warm up the paint from low storage temperatures to the required processing temperature. For example, it can take three days to heat the paint from 10°C to 20°C if stored at 20°C in a 1,000-litre container without stirring. This must be appropriately allowed for when designing and planning storage and paint supply rooms (23,24).

Waterborne basecoats are non-Newtonian in their viscosity behavior. Figure 6 illustrates the rheological characteristics of metallic waterborne basecoats. Owing to the relationship between viscosity and shear gradient with intrinsically viscous paints, the dynamic viscosity of waterborne basecoats at rest is considerably higher than that of solvent-containing basecoats. As the customary flow cup for determining the viscosity of paints only provides reliable data for Newtonian liquids, other processes such as rotation viscometers are recommended.

Experience with rotation viscometers shows that they are also suitable and easy to use in actual practice in paint shops. Conventional flow cups can also be used for certain products as a check in production after consultation with the laboratory responsible and after appropriate shear loading (defined stirring). Moreover, to obtain an accurate viscosity setting, it is necessary to keep the temperature and pH of the paint and, optionally, that of the deionized water used for setting, within the specified tolerances. The correct pH setting has an impact on the shelf life of the paints and on painting properties such as drying, gloss, solvent resistance, and humidity performance.

In the paint circulation system for waterbased materials, owing to their viscosity properties and the dilution properties of water, water-thinnable paints require special handling be observed in both the theoretical design and practical implementation stages (Fig. 7).

In automated and robot application, the material temperature in the storage tank should be kept constant within the working range of 20°C to 30°C, for example, at  $23 \pm 1^\circ\text{C}$ . The specific heat of water is to be taken into account accordingly (see Section 7.2). Circulation systems, which can be exposed to severe temperature fluctuation, must be insulated or provided with thermostatic temperature control. In addition, storage tanks, pipes, filters, and all other paint-carrying elements must be made of stainless steel (cf. table of the tested grades) or of suitable plastics.

For paint application, the characteristic viscosity behavior of waterbased paints under shear loads must be considered. Constant and defined material flow

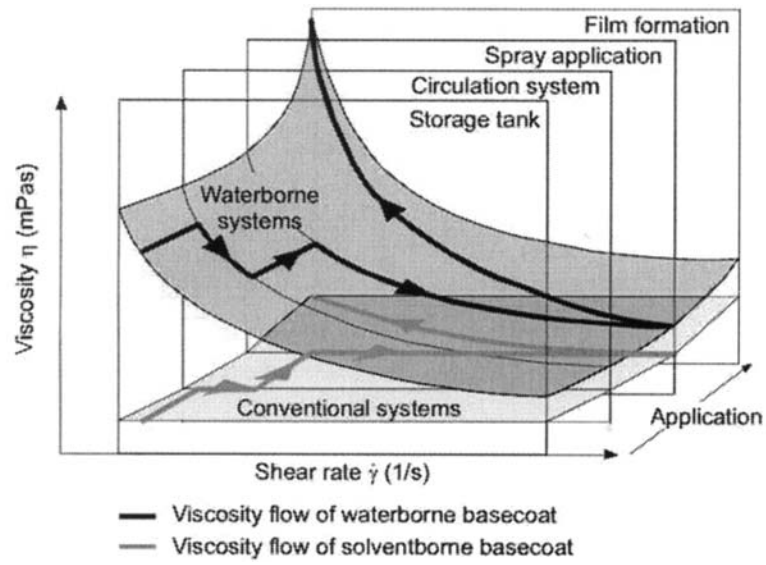

FIG. 6 Rheologic characteristics of waterbased basecoats. Comparison of conventional and waterborne systems.

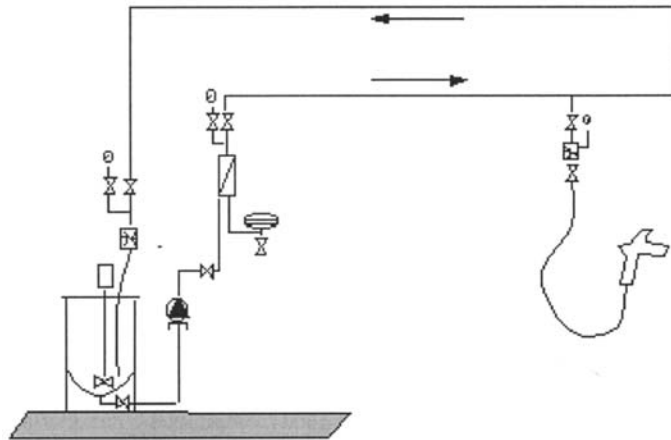

FIG. 7 Circulation system for waterbased basecoats.

rates can be achieved, for example, with volumetric dosing or with a combination of accurate flow measurement and volume control. It is imperative to avoid the use of silicone-containing and similar surface-active materials for the lubrication of seals, pumps, and valves as the entrainment of such materials can induce cratering of the water-based paint material.

Tight control of temperature and relative humidity of the spray booth is essential for the successful application of waterbased basecoats. The influence of the climatic parameters in spray booths is much greater than with conventional systems. The paint's evaporation behavior is influenced by the relative humidity of the air, the temperature, and the speed of the surrounding air during the process of atomization, film formation, and evaporation processes. The main factor for determining the optimum climatic conditions is the relative air humidity. In the working range of about 20°C to just over 30°C, the effect of the air temperature is not very significant when the air humidity is monitored and adjusted accordingly. The processing range is selected so that, allowing for the typical climatic conditions in the processing country, the humidity and heating are sufficient to set optimum air conditions in the spray booths.

Dehumidifying and cooling facilities would multiply the amount of energy required and are therefore to be avoided as far as possible for both ecological and economic reasons. With the paints designed for Central and Northern Eu-

**TABLE 7A** Suitable Austenitic Stainless Steel

| Material No. | DIN norm short name  | Composition in % weight |      |      |       |      |               |             |               | AISI norm |
|--------------|----------------------|-------------------------|------|------|-------|------|---------------|-------------|---------------|-----------|
|              |                      | C                       | Si   | Mn   | P     | S    | Cr            | Mo          | Ni            |           |
| 1.4301       | X5<br>CrNi 189       | ≤0.07                   | 1.00 | 2.00 | 0.045 | 0.03 | 17.0–<br>20.0 | –           | 8.5–<br>10.5  | 304       |
| 1.4306       | X5<br>CrNi 188       | ≤0.03                   | 1.00 | 2.00 | 0.045 | 0.03 | 17.0–<br>20.0 | –           | 10.0–<br>12.5 | 304 L     |
| 1.4401       | X5<br>CrNiMo 1810    | ≤0.07                   | 1.00 | 2.00 | 0.045 | 0.03 | 16.5–<br>18.5 | 2.0–<br>2.5 | 10.5–<br>13.5 | 316       |
| 1.4436       | X5<br>CrNiMo 1812    | ≤0.07                   | 1.00 | 2.00 | 0.045 | 0.03 | 16.5–<br>18.5 | 2.5–<br>3.0 | 11.5–<br>14.0 | 316       |
| 1.4541       | X10<br>CrNiTi 189    | ≤0.10                   | 1.00 | 2.00 | 0.045 | 0.03 | 17.0–<br>19.0 | –           | 9.0–<br>11.5  | 321       |
| 1.4571       | X10<br>CrNiMoTi 1810 | ≤0.10                   | 1.00 | 2.00 | 0.045 | 0.03 | 16.5–<br>18.5 | 2.0–<br>2.5 | 10.5–<br>13.5 | 316 ti    |

**TABLE 7B** Suitable Synthetic Materials/Plastics

|       |                         |                         |
|-------|-------------------------|-------------------------|
| PA 11 | Polyamide               | e.g., side tubes        |
| PTFE  | Polytetrafluorethylene  | e.g., sealing/membranes |
| PVDF  | Polyvinylidene fluoride | e.g., sealing/membranes |

rope the processing spectrum lies between 50 and 80% relative air humidity. The lower air humidity limit is selected in view of the fact that a defined threshold is advantageous for electrostatic application. Single-color basecoats as well as the first film of effect basecoats can also be processed using electrostatic high-rotation bells (see following text). However, the tolerance range for the air humidity is narrower for reproducible effect painting. Optimum painting results can be obtained with a relative air humidity of  $60 \pm 5\%$ . Outside this optimum range changes in the metallic flop effect and color variation can be expected but, in principle, still acceptable painting results can be achieved.

Outside the defined application range the flawless application of single-color basecoats may still be guaranteed by additional measures (adaptation of viscosity, addition of organic solvents or additives). With effect basecoats, however, variations in the effect can then be expected. For regions with different climatic parameters, making the appropriate modifications to the paint system can result in a different set of optimum conditions for application. The overall process using water-based basecoats involves additional process steps due to the fact, that a conventional flash off is not sufficient to evaporate the water from the film to allow for application of the solventbased clearcoat and a thermal drying step is needed for this. Typically, the basecoat should have a minimum of 90% solids prior to clearcoat application.

In view of the process technology features (application stages, evaporation cycle between basecoat and clearcoat), the following presents typical examples

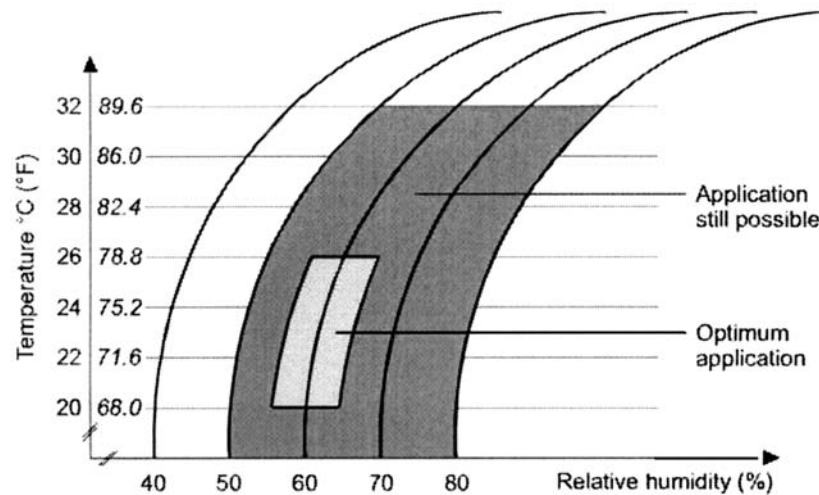

Fig. 8 Processing window for application of waterbased basecoats.

**TABLE 8** Application Parameters for Waterbased Basecoats

|                           |  |
|---------------------------|--|
| First spraying operation  | Metallic basecoats approximately 6–8 $\mu\text{m}$ dry film thickness                |
|                           | Air speed 0.4 to 0.6 m/s   |
|                           | Relative air humidity 60 $\pm$ 5%  |
|                           | Room temperature 23 $\pm$ 3°C  |
| Intermediate flash-off    | Approximately 2 min. @ 23 $\pm$ 3°C  |
| Second spraying operation | Metallic approximately 6–8 $\mu\text{m}$ dry film thickness                          |
|                           | Air speed 0.5 m/s $\pm$ 0.1 m/s  |
|                           | Relative air humidity 60 $\pm$ 5%  |
|                           | Room temperature 23 $\pm$ 3°C  |
| Air lock                  | (Approximately 3 to 5 min.)  |
| Final flash-off           | Approximately 6 min. at 60°C (drier rated for 80°C)<br>on work piece 2 $\pm$ 0.5 m/s |
| Cooling                   | The substrate in the discharge lock of the blowing<br>tunnel with fresh air to 30°C  |

for the processing of waterborne paints. A case-to-case examination has to be made as to whether integration into existing painting lines is possible. However, the paint supply system and the application technology must always be adapted.

The most widely used pneumatic application process, manual and/or automatic processing, is described in detail as an example. In general, the parameters also apply to electrostatic processing. Further details are given in the next paragraph.

The effect of the humidity (see processing range) is more crucial with waterborne basecoats than with conventional systems. Even after a 10-minute flash-off period there is still too much residual solvent in the paint film under

**TABLE 9** Pneumatic Spray Application Parameters

|                                    |                            |               |
|------------------------------------|----------------------------|---------------|
| Hand spray gun, stainless steel    | DeVilbiss JGV-563 St       |               |
| Automatic Gun, alternatively       | DeVilbiss AGMD, ABB, Behr  |               |
| Nozzle ( $\varnothing$ mm)         | 1.1/1.4                    |               |
| Air cap (DeVilbiss)                | 765/789/797                |               |
| Sprayer air pressure (bar) dynamic | 4–5                        | 5–6           |
| Material flow rate (ml/min.)       | 200–400                    | 200–400       |
| Object distance (mm)               | 250–300                    | 250–300       |
| Booth temperature (°C)             | 23 $\pm$ 3                 | 23 $\pm$ 3    |
| Relative air humidity (%)          | 60 $\pm$ 5                 | 60 $\pm$ 5    |
|                                    | (best spraying conditions) |               |
| Down draft (m/s)                   | 0.5 $\pm$ 0.1              | 0.5 $\pm$ 0.1 |

normal booth conditions and therefore a special evaporation tunnel is needed. In the actual painting of plastics a combination of infrared drying and subsequent blowing off with heated air has not proved successful for the forced evaporation of waterborne basecoats and instead pure convection drying is recommendable. Figure 9 shows a temperature curve for this basecoat clearcoat application and bake process.

Over the last years, several new concepts for the integration of waterborne basecoats into existing paint shops have been introduced. Due to the three-dimensional, complicated geometry and poor temperature stability of many plastic parts, development of high-temperature radiation dryers (like infrared [IR] and ultraviolet [UV]) could not be introduced. With the exception of some middle- or long-wave infrared heaters, and also a few catalytic gas dryers (for smaller and more flat parts) in Great Britain and in France, process engineers and plastic coaters studied alternate dryers that operated at low temperature and worked on the principle of condensation. For these types of systems, closed air circulation is needed and the relative humidity must be less than five grams per kilogram of air. Processing temperatures are approximately 40°C. These conditions offer the benefit of a shorter process and the typical cooling time period that is required after drying is not necessary.

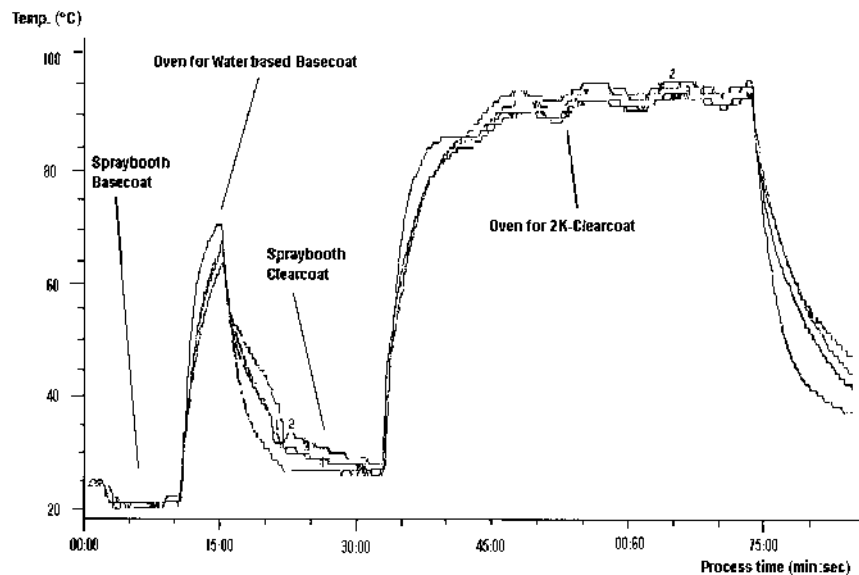

Fig. 9 Temperature curve for waterbased basecoat-waterbased clearcoat.



In view of the increasing significance of painting plastic surfaces electrostatically, this process is explained in more detail. Electrostatic painting has been the main standard method for coating metallic substrates for many decades. The advantage of this technique is the low loss of paint mist compared with purely pneumatic spraying processes. As a result, it is a cost-effective method of delivering paint to a part.

Particularly more and more color harmony is required between the car body and the plastic parts. This can be very challenging because most off-line application methods are not at all similar to that of the car-body paint lines. In an attempt to improve this color harmony, conveyor systems have been built to hang and carry the plastic parts in car-body position through the plastic paint line. Also the application concept with the typical electrostatic atomizer is in use, similar to that used with the car body. Examples of robot types used in Europe are ABB and Fanuc.

Electrostatic units operate on two principles, the purely electrostatic method and those methods with additional auxiliary energy for paint atomization. One thing that all processes have in common, however, is the fact that electrostatically charged paint droplets when sprayed are transported to the grounded part under the action of the electrostatic field and deposited on the job. Electrostatic application on plastics is a little more sensitive than the process used on the car body, as the typical plastic part is not inherently conductive. For optimum transfer efficiency the experience is, that a specific system resistance has to be less than one Mega-Ohm. Best results are measured in a combination of waterborne basecoat with an underlying layer of conductive primer. The high conductivity of the wet waterborne paint increases the transfer efficiency higher than normal.

Electrostatic painting using high-rotation atomization is characterized by a considerably higher transfer efficiency (24,25) compared with pneumatic atomization. Spraying is performed purely mechanically at the bell edge. This process promises to exhibit the highest efficiency for coating plastic parts. Under the pilot plant conditions at DuPont, paint utilization of up to 60 percent was attained on bumpers whereas in a conventional pneumatic plant approximately only 30 percent is achieved. In practice, these figures are considerably lower when applied through electrostatic application owing to poor grounding. In spite of these advantages, the use of electrostatic high-rotation sprayers has for a while only been partially implemented for the application of "effect" basecoats. Normally, variations in color and a different flop behavior compared with pneumatic atomization occurs, which would clearly become noticeable as an optical flaw in the repair of parts without electrostatics in series production or in the field.

The color and effect deviations that are usually seen are attributed to the different atomization and transport conditions of the paint droplets, the different

evaporation behavior of the solvents contained in the atomized droplets and the different kinetics of the droplets when they impact on the surface being painted. These differences induce an alignment of the aluminum platelets or other effect pigments causing the color deviation (see Fig. 10). However, in spite of this limitation, currently between 50 and 70 percent of the dry film thickness of effect basecoats can be applied electrostatically without any loss of optical quality. To apply as much as possible, ideally up to 100 percent of the basecoat, through electrostatic application requires close cooperation of all partners throughout the whole development process, starting with the OEM stylists.

Surface tension, viscosity, and the paint thickness influence the droplet size distribution and the average droplet diameter just as much as the angular velocity, diameter, and specific design details of the sprayer in conjunction with the paint throughput. In this context, the very low electrical resistance of the water in water-thinnable basecoats deserves special attention. If the paint is supplied from a closed-circuit pipe, the high voltage present at the spraying head owing to the paint column created can be discharged into the entire supply system. The possibility of completely interrupting the paint column with optimum safety by means of intermediate replenishing tanks operated in isolation was previously used with waterborne fillers in automobile painting. Figure 11 shows a typical replenishing tank system. As a replenishing tank located in the voltage cascade and requiring a relatively large space was needed for each color,

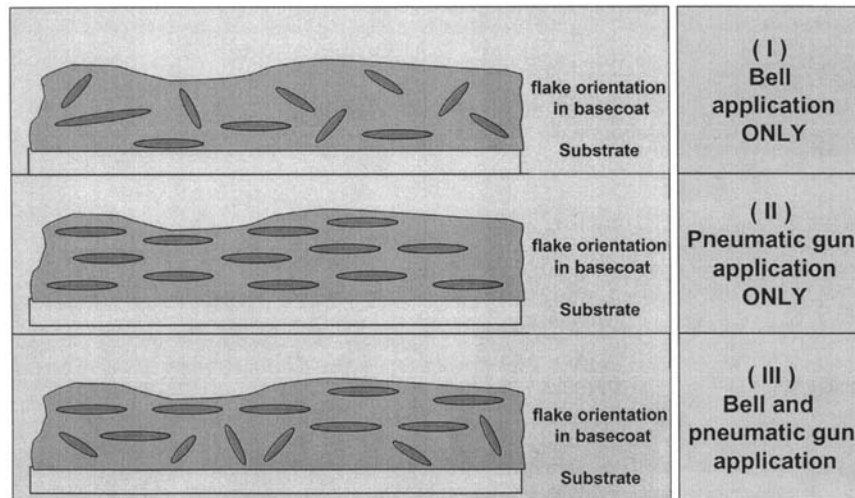

Fig. 10 Aluminum- or mica-flake orientation in HR-bell and pneumatic spray.

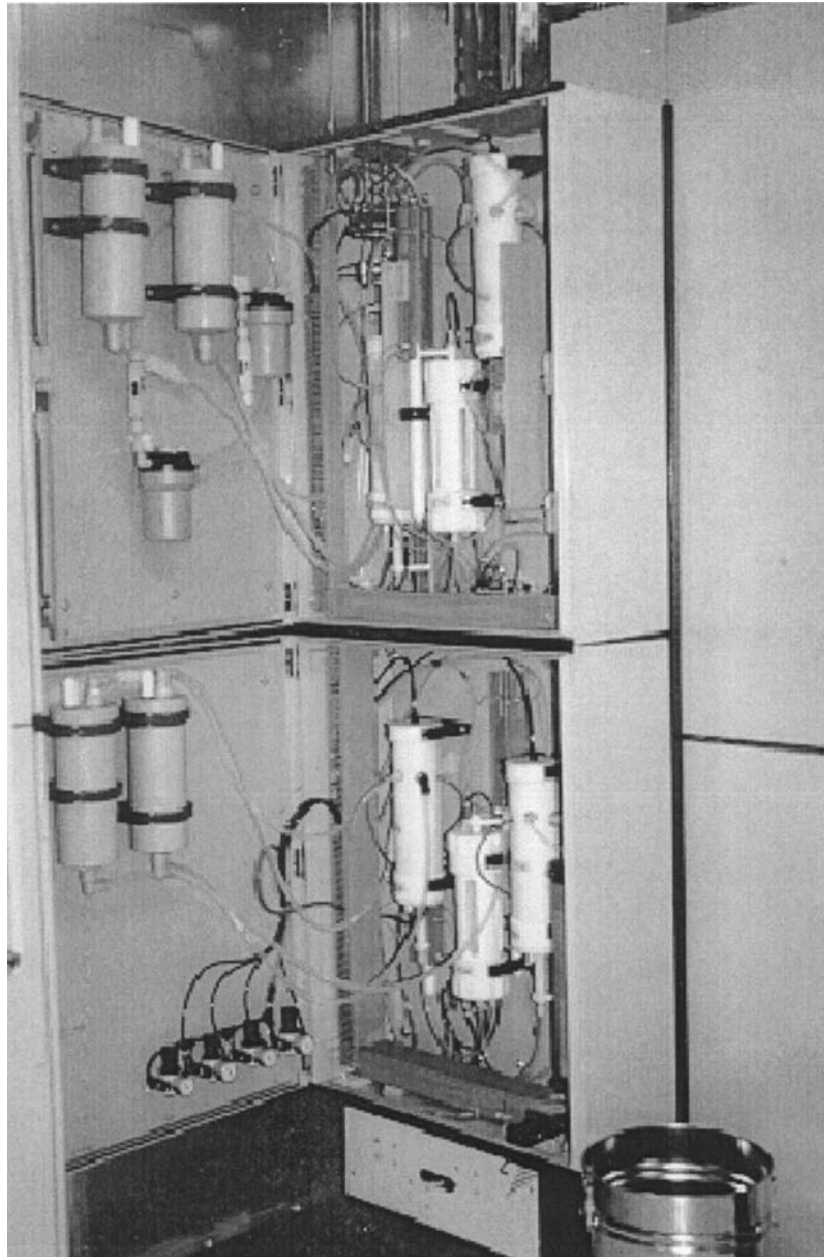

FIG. 11 Intermediate replenishing tank system, ohmic insulated for electrostatic waterbased basecoat application. (Courtesy of: LACTEC GmbH, Rodgau, Germany.)

it was not possible to transfer such a solution to basecoats with their wide variety of shades.

At present, the standard solution for basecoats is therefore still the concept of high-rotation atomization with external charging. In this case, the paint is merely sprayed by high rotation. The electrostatic charge is created in a second stage by the air ions attaching themselves to the paint droplets in the high-voltage field between the external charging electrodes and the object being painted. The field geometry, voltage, shaping air, air velocity, and air humidity in the booth must be set in relation to each other so that return-spray effects, which could lead to contamination of the electrodes, are avoided.

### 7.3 Clearcoats

Due to the plastics and molding conditions used by the European automotive industry, the maximum curing condition for bumpers, grilles, side claddings and most other plastic items is 90°C (194°F). Therefore, since the early 1980s isocyanate curing 2K clearcoats have been used. Initially, highly flexible, polyester resins were needed in the backbone to avoid deterioration of the low-temperature impact resistance of the painted part. A cryogenic polishing technique, using liquid nitrogen, was carried out to touch up any of these parts when and if defects were seen. More recently, clearcoats have been developed with built-in flexibility providing good low-temperature impact, which can be polished at ambient temperature.

In terms of resin chemistry, the clearcoats are based on a hydroxy-functional polyester and acrylic-resin blend. The polyester is responsible for providing the high flexibility at low temperature. The hardener is based on hexamethylene diisocyanate (HDI) trimer. Ultraviolet absorbers (UVA), and hindered amine light stabilizers (HALS) are additives added to absorb UV light, protect the basecoat pigments and to quench free radicals that could deteriorate and decompose the backbone resins.

To meet the need for very robust products, new products are continually being developed that may be applied at low cost through high pressure spray guns or through high-efficiency bells with little risk of popping, nonuniform film build, or even sagging over a wide range of film builds. High skills are needed in the formulation chemist. Formulation tools are needed to build structural viscosity to avoid sagging “in the booth,” thixotropy is needed to avoid sagging in the “flash off” zone, and temperature-induced viscosity is needed to control the film in the oven on vertical areas of the molded part.

The typical product used on the European continent is a medium solids 2K clearcoat. In the United Kingdom however, local authorities require products with VOCs less than 420g/l. Clearly, these higher solid products have limited use compared to their medium solid counterparts when highly effective applica-

tion with smooth orange peel, even at low film build, is needed. In addition to solvent-based clearcoats, water-based clearcoats have also been developed and these trial products are under evaluation for industrial use (26). Figure 12 shows a typical application of a waterbased clearcoat.

## 8 BODY PARTS

To a growing extent, the European automotive industry uses plastic and thermosetting materials for body applications. Two materials, SMC and PPO/PA are dominating in this area. It was in the early 1980s that SMC first appeared on middle volume vehicles and since then it has been used to a higher or lower extent, depending on the automotive OEM. Typical application for these materials are tailgates, an early example being the Audi Avant. Today, SMC plays an increasing role in this area and a number of variations of this technology are currently used.

A SMC trunk lid is assembled on DaimlerChrysler's S-Klasse Coupe. This part is precoated with an in-mold coating (IMC) and a black conductive primer. It is assembled to the body and passed through a cathodic electrodeposition tank, with no coating adhering to the SMC part. The black conductive primer allows for electrostatic application of primer surfacer and topcoat along with the automobile body. Renault (VelSatis) and Volvo (V70 station wagon) tailgates are coated completely off-line, without the use of IMC, and are coated with a dual primer system consisting of highly conductive primer and a light gray,

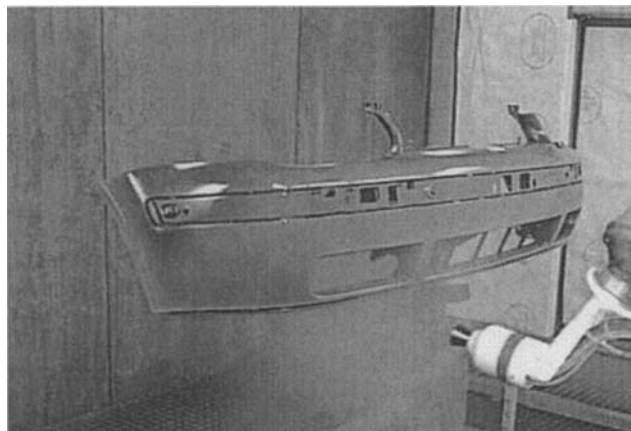

**FIG. 12** Application of waterbased clearcoat. A few minutes after application, the wet film changes from "milky" to "transparent".

nonconductive primer on top. Renault also topcoats SMC fenders that are primed with a conductive powder coating.

Despite many improvements in SMC technology, the major problem of popping has not been completely eliminated. Porosity, due to gas inclusions mainly on the edges and wherever the part has been stressed, limits the scope of many SMC applications. To cope with this inherent porosity best, two “theories” are followed. The first is to have a process starting with high temperatures of the primer bake. In this early stage, any pores popping out can be filled with putty. Due to the lower temperatures used later in topcoat bake, a minimum of pores are assumed to pop due to a sealing effect of the paint film. The primers used in this method are 140°C melamine-cured systems. More recently, according to the second theory, the overall process to coat SMC should be performed at low temperature. Low-bake 2K primers have been commercialized to effectively reduce the amount of visible porosity.

In increasing volume, hard polyurethane (PU) composites are commonly used for body applications, like hardtops. Typically, a reinforced molding covered by a 3 mm skin, is coated off-line. In addition to thermosetting materials, highly temperature-resistant thermoplastic polymers have been introduced to this body technology. A particularly suitable thermoplastic material for body components is the blend of PPO/PA. The structure is a matrix with spherical domains due to the noncompatibility of the polymers. As the PA phase is semicrystalline, shrinkage phenomena of the plastic also have to be considered. When using the part for “on-line coating” processes, a topcoat cure of 140°C (285°C) or higher has to be taken into account with mold dimensions. Typically in these cases, the provider of the primed part is requested to use 140°C primer bake to pre-shrink the part for optimal body fit when assembled to the vehicle.

A few examples illustrate as with SMC parts, for PPO/PA body components, many different coating options are used and no general coating process has been established. DaimlerChrysler's A-Classe has a Noryl tailgate that is completely coated off-line in body color. The fenders of the same car however, are primed using a conductive primer and are assembled “after e-coat” for on-line coating. This is accomplished using a functional-surfacer, water-based basecoat and powder slurry clearcoat. Other fenders like that on the Audi A2, are coated completely off-line. For Renault's Scenic and Clio models, black conductive PPO/PA is used so that the part can be coated on-line after passing through the electrocoat bath.

## 9 INTERIOR AUTOMOTIVE COATINGS

Interior design of automotive vehicles in Europe today is an important factor in their sales success. The design stylists try to create a complete harmony of the interior trim using a combination of leather, woven fabrics, wood, and plastic

surfaces. In our perception, plastics don't meet the stylist's wish for idle or luxurious materials and hence the trend is to apply a coating finish to make the plastic surface more appealing.

A wide range of finishes is at disposition of the designer. Traditional "low-gloss coatings" can make plastic components made of different materials or molded by different techniques, look alike and offer a elegant finish. Especially when in dark colors, they eliminate or minimize reflection in the under window area of the car's interior. Lighter colors are the trend for components below this area where low-gloss finishes can look comparable to natural materials. Additional highlight styling elements are high-gloss metallic or pearlescent coated trim moldings. Galvanic metallizing of ABS-plastics in chrome, brushed aluminium, or other special effects are used and usually coated with a special clearcoat to protect the finish. Alternatively, chrome effect basecoats are available. For even greater design variation, techniques like Cubic® for almost any graphic and colored pattern or picture have been developed and special clearcoats are also needed to support the appearance of the finish with respect to gloss, smoothness, and light refraction. Functional coatings combine both an attractive design with functional needs, for example laserable coatings to label buttons, displays, or special paints to provide physical properties to material surfaces.

The automotive stylist has to focus on more than just what is seen with the human eye, he has to appeal to the other senses. Antisqueak coatings can be applied to avoid unwanted noise that can be created when adjacent plastic surfaces rub against one another. Interior coatings can add an idle smell to the component and also give the perception of the surfaces when touched by the hand. Based on the human experience with natural matters, a range of high elasticity materials with certain friction to our fingertips is pleasantly perceived and coatings providing this effect are called softcoatings. Very often, manual operation elements like gear knobs, door handles, hand brakes, and radio knobs are given soft coatings. More and more all surfaces within the reach of the driver and passenger now have this soft finish including middle consoles, dashboard inlets, armrests, and airbag covers.

According to simple model considerations, soft coatings can be accurately described in terms of their elasticity modulus and frictional resistance. When moving our fingertips along the surface of a soft coating, a minimal shift of the film surface versus the lower face bonded to the substrate occurs and can be "felt." What we feel in physical terms is the sheer modulus of the film. Sheer modulus is related to tensile modulus and, using Poisson's constant ( $P$ ), can be transformed into the other using the following equation:

$$\text{Tensile Modulus} = 2(1 + P) \text{ Shear Modulus} \quad \text{Eq. (1)}$$

Hence, dynamic tensile measurements are suitable to characterize paint materials in terms of a number of factors such as a "storage factor" and a "loss

factor.” Both of these factors describe the energy of distortion that can be recovered or lost by heat formation when a paint film is sheared. Other available data that may be obtained includes “time lag” of the periodically applied shear stress and shear strain. Both these are temperature influenced and can be seen in Figure 13. According to the shear model, thicker films exhibit better soft effects because a defined shear stress gives more shear strain. Typical soft coatings are applied in the range of 40 to 60 $\mu$ m.

Additives and pigments can influence the type of soft effect we feel without dramatically changing the sheer modulus and the friction of our fingers to the paint film is responsible for this. When testing textured surfaces rather than smooth ones, things can get quite complicated and on these surfaces, qualification by trained test personnel is the only way to consistently characterize soft coats.

In a somewhat simplified characterization, different types of soft-touch coatings can be represented in terms of resin shear modulus and frictional behavior of the film surface (see Fig. 14). For better quantification of the latter, “artificial” fingertips for test purposes are currently under evaluation.

For soft finishes, solventbased and waterbased coatings are available both in middle and northern Europe, with the waterbased widely dominating the market. The chemical basis of waterbased finishes is based on a 2K polyol-isocyanate. Suitable polyols are special aqueous polyurethane dispersions. The isocyanate is provided in liquid form and usually contains a small amount of suitable solvents. Mixing to get the paint ready to spray can be done in small lots as most of these 2K materials exhibit a pot life of about one hour at ambient temperature. However, it is best to apply soft coatings through 2K automated mix equipment with modified statical mixers.

These waterbased soft paints adhere to many plastics. Clearly ABS dominates in the interior trim market. In cases where polypropylene blends are used, a consistent pretreatment by flaming or fluorination is necessary to get adequate adhesion. For the application of waterbased soft paints, some pertinent data is given in Table 10.

Soft coatings mostly are solid colors like black, gray, beige, blue, and others. In addition to this, certain metallic effects such as pearlescent effect textures can be provided. Also, soft clearcoats over special metallic basecoats also have become available recently.

In addition to standard applications, special soft coatings exist that offer a wide range of options. For example, infrared reflecting coats have been patented (27), and are available for dashboards to help reduce component temperatures that often reach 90°C, especially in dark colors. If these high temperatures can be reduced, the dashboards can be constructed much easier, cheaply, and at less weight. Antibacterial soft coatings have recently been offered for door handles, steering wheels, and gearknobs of rental cars. In addition, flame-retardant



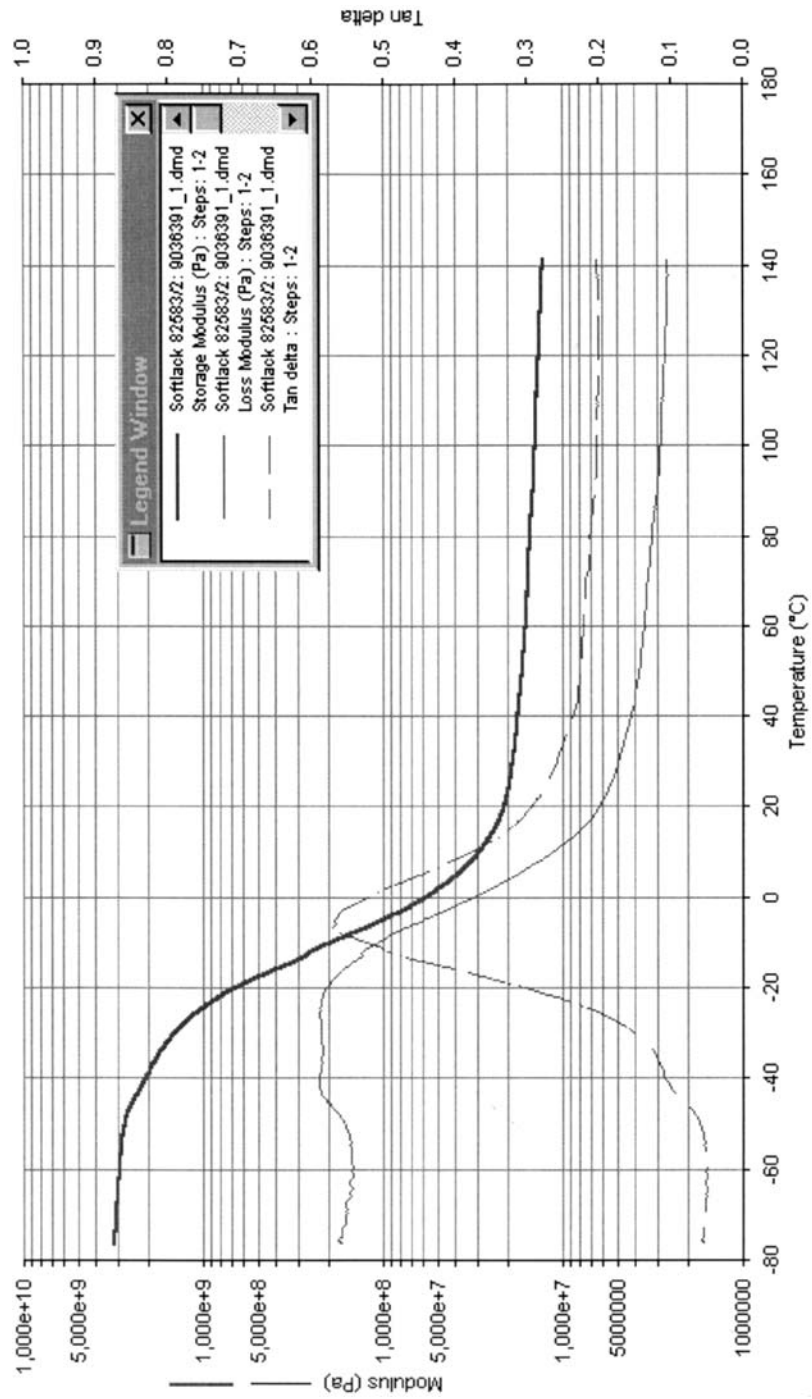
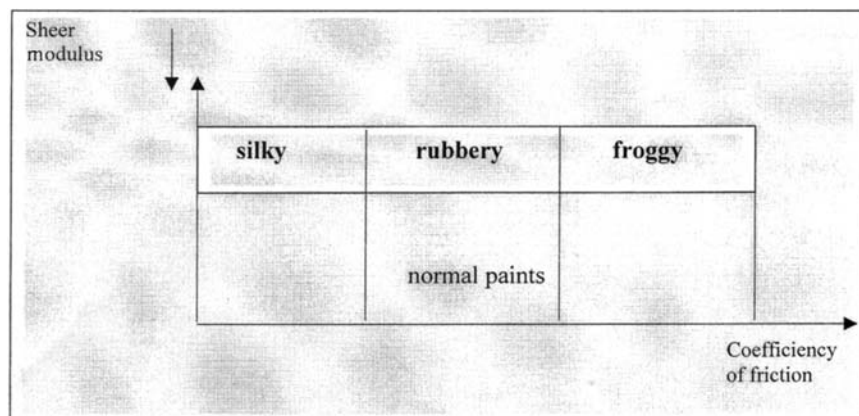

Fig. 13 Dynamical mechanical analysis of a softcoating film. Tensile Stress: 1 cps/sinus, Tension: 1%.



**Fig. 14** Representation of softtouch coatings in terms of shear modulus and frictional resistance.

coatings can greatly contribute to the safety of passengers in modern vehicles when accidents do occur.

## 10 FUTURE DEVELOPMENTS AND SUMMARY

To meet emerging ecological legislation needs for cost reduction and high-quality standards, plastic coatings in Europe will change on a number of fronts. The material of choice will remain for large components in the car body's impact area, but the range of commercial grades will widen. At both ends of the flexural modulus scale, new products will be introduced, highly crystalline at the high end and rubber-like blends at the low end. For body components where stiff

**TABLE 10** Process Data for the Application of Waterbased Soft Coatings

|                         |                                    |
|-------------------------|------------------------------------|
| Equipment               | Stainless steel, suitable plastics |
| Relative humidity       | 50–70%                             |
| Spray booth temperature | 21–28°C                            |
| Spray gun nozzle        | 1.6 mm                             |
| Atomization pressure    | 5 bar                              |
| Flash-off               | 8 min. @ 26°C                      |
| Oven cure               | 40 min. @ 80°C                     |

moldings are needed, further replacement of metal by SMC and new reinforced and “sandwich-type” plastics is expected. The engineer needs to have available tailor-made materials to select from, for wanted or unwanted EMI shielding, for modern electronic equipment. For SMC, new technologies like UV cure are under development to minimize porosity problems.

Flaming will remain the dominating technique for pretreatment of TPO, but will be enhanced by complementary methods for special purposes. Plasma polymerization has the potential to provide both adhesion and an electrical conductivity, but today the technique is in an early immature phase.

Waterbased primers are already being used today for TPO and other plastics. These primers have been improved and formulated to offer adhesion even on unflamed laboratory TPO plaques. This will allow for waterborne coatings to be used on complex three-dimensional moldings, where flaming can induce local adhesion failure. For waterbased basecoats, two options will be available to the automotive supplier to copy the OEM body coating as best as possible and use original OEM basecoat or to use waterbased plastic basecoats tailor-made for the specific plastic part or the specific coating process. As to the clearcoat, for high-volume plants, waterbased clearcoat will be introduced shortly. As an alternative, mainly for medium-size production, new legislation permits increasing use of high-solid clearcoats will be introduced. For specific parts like interior components, wheel trims using UV clearcoats will become more prevalent and increasingly more important.

## REFERENCES

1. D Booth. European outlook for TPO-TPEs, an automotive focus. Proceedings of the SPE Automotive TPO Global Conference, Troy, MI, 1999, pp 11–20.
2. DP Jones, DC Leach, DR Moore. The application of instrumented falling weight impact techniques to the study of toughness in thermoplastics. *Plastic and Rubber Processing and Applications* 6:67–79, 1986.
3. Official Journal of the European Communities L85, 29.03.1999.
4. T May. *Umweltmanagement im Lackierbetrieb*. Vincentz Verlag, 1997.
5. T May. Deutsche Loesemittelverordnung beschlossen. *JOT* 10:8–11, 2001.
6. E Seitzl, F Altendorfer. Innovative Kunststoffe fuer den Stossfaengerbereich Kunststoffe 84. Jahrgang 8:236–241, 1994.
7. C Gruner, B Rapp, H-J Zimmermann. Problemlösungen beim Lackieren von Polypropylen Blends Kunststoffe 82. Jahrgang 9, 1992, pp 4–7.
8. M Osterhold, K Armbruster. Oberflächenspannungs- und ESCA-Messungen an vorbehandelten Kunststoffproben. *Farbe und Lack* 97:780–783, 1991.
9. M Hill. Die Beflammung als kostengünstiges Vorbehandlungsverfahren fuer Kunststoffe. Erfolgreich Lackieren von Kunststoffen Congress Praxis Forum Oberflächentechnik Bad Nauheim, Germany, 1996.
10. Y Takahashi, K Fukata, T Kaneko. Plasma treatment for painting of polypropylene

- bumper exterior body panel development. International Congress and Exposition, Detroit, MI, 1985, pp. 65–72.
11. TA Wilde, H Gruenwald, H Bickmann. Plasma am laufenden Band. JOT Heft 11: 18–24, 1992.
  12. S Fischer, K Jesch. Kunststoffteile im Innen- und Aussenbereich fluorieren und einschichtig lackieren. Praxis-besser lackieren 17, 2000.
  13. L Dorn, R Bischoff. Plasma gun. Adhaesion ½:27–30, 1989.
  14. D Navarre, B Brault. Adherence sur Polypropylene: Traitement U.V. SURPLAST VI Lyon Hotel Sofitel 5 et 6 Novembre 1997.
  15. L Stechmann, D Koch, M Zeja, M Minkow. Plasmapolymersation zur Erzeugung von lackhaftenden, elektrisch leitfaehigen Kunststoffoberflaechen. Machbarkeitsnachweis, INPRO, Berlin, July 2000.
  16. J Hocken, WD Griebler, J Winkler. Elektrisch leitfaehige Pigmente zur antistatischen Ausruestung polymerer Beschichtungsstoffe. Farbe und Lack 89. Jahrgang 1:19–24, 1992.
  17. DE 40 14 212 C2 (German Patent). C de Oliveira Santos, C Gruner. Effektbasislack zur Beschichtung von Polypropylensubstraten, May 3, 1990.
  18. EP 0 455 211 B2 (European Patent). C Gruner, C de Oliveira Santos. Process of effect-coating of polypropylene substrates. April 30, 1991.
  19. RA Ryntz. Adhesion to Plastics-Molding and Paintability. Global Press, 1998, p 37.
  20. C Koevoets, D Nordegraaf, U Hofmann. Leitfaehige Kunststoffe. Kunststoffe 86: 358–360, 1996.
  21. W Nowak, A Pothoven. Das smarte Bodypanelsystem. Mannheim, Germany: 1999, pp 335–337.
  22. K Alders. Die lackierung wagenfarbiger anbauteile am beispiel der neuen lackiererei AUDI in ingolstadt. Symposium Praxis Forum, Bad Nauheim, 19/20:85–94, 1998.
  23. FL Siever. Anwendungstechnische fragestellungen bei wasserlack. Symposium Praxis Forum, Bad Neuheim 2/1996, p 10.
  24. Brochure Herberts (now DuPont Performance Coatings), Waterborne Basecoat Technology, 1996.
  25. W Ott. In: Erfolgreiches Lackieren von Kunststoffen. Symposium Praxis-Forum, Bad Nauheim 2/1998.
  26. W Hovenstadt, B Klinksiek, M Melchior. Homogenes Vermischen von waessrigen 2K Polyurethanlacken. Farbe und Lack 106. Jahrgang 7:40–44, 2000.
  27. EP 0 800 558 B1 (European Patent). US Patent 5,962,143 October 30, 1996. H Krauthaeuser, C Gruner, G Huthmacher. Coating composition for producing heat radiation-reflecting coatings, 30.10.1996.

## Index

- Acetoacetate, 259
- Acrylic resins, 132–133, 135
- Additives, 249
- Adhesion:
  - cohesive failure, 164
  - compressive shear delamination, 164
  - contact angle, 23, 161
  - durability balance, 100–101, 103–106, 109
  - failures, 219–221
  - interfacial binding energy, 23
  - mold release agents, 161
  - promoters, 31, 86–87, 95–96, 187
  - surface tension, 161
  - testing, 26, 164
  - thermal shock, 164
  - wetting, 23
  - work of, 89–90
- Alkyds, 48, 51
- Alloys, 247
- Amorphous polymers, 246
- Antisqueak coatings, 347
- Application parameters for waterborne basecoats, 339
- Artificial fingertips, 348
- Atomization, high rotation, 344
- Automotive plastic:
  - coatings, in Europe, 317
  - markets, 3
- Automotive shredder residue, 269
- Aziridine, 259
- Basecoats, 263
  - solventborne, 331
  - waterborne, 332–333, 335
  - application parameters for, 339
- Bezels, 253
- Block copolymers, 14
- Blowing agents, 67
- Blowing processes, 78, 79
  - extrusion blow molding, 78
  - injection blow molding, 79–80
- Blow molding applications, 252
- Body seals:
  - coatings and, 311
  - colors, 311
  - roles, 310
- Bond strength, 92

- Bumper, 318
  - coating of, 322
- Carbamate, 258
- Carbodiimide, 259
- Catalyst, 49
- Cathodic electrodeposition, 345
- Cellulose acetate butyrate (CAB), 332
- Center consoles, 253
- Charge dissipation, 36–40
- Chemical:
  - resistance, 170
  - treatment, 86
- Chipping, 168
  - resistance to, 256
- Chlorinated polyolefins (CPO), 31, 96, 126, 325–326, 329
- Clean Air Act, 254
  - Amendments, 254
- Clearcoats, 264, 344
- Coalescence, 153
- Coatings:
  - alternates, 279, 297
  - antisqueak, 347
  - appearance, 159
  - automotive market, 295–296
  - basecoats, 189–190
  - and body seals, 311
  - and bumpers, 322
  - clearcoats, 190
  - desirable features, 2
  - exterior, 7
    - requirements, 298
  - functions, 294
  - hindered amine light stabilizers, 190
  - in-mold, 268, 345
  - interior requirements, 298
  - low gloss, 347
  - multigrain, 312
  - nonpolluting, 265
    - (*see also* Nonpolluting coatings)
  - off-line, 318, 331
  - one-component, 191–193
  - on-line, 318, 331, 346
  - physical properties, 158
  - of polycarbonate, 329
- [Coatings]
  - powder, 153
  - precolored plastics, 62
  - radiation cured, 149
  - surface:
    - appearance, 62
    - migration, 159
  - trends, 299
  - two-component, 193–195
  - ultraviolet absorbers, 190–191
  - waterborne, 152
- Co-injection molding, 67
- Colorants, 282
- Color harmony, 341
- Compatibility, 96, 131, 272–273
- Composites, 3
- Conductive carbon black, 110
- Conductivity, 110–111, 326
- Contact angles, 89, 211–213
- Control technique guidelines, 254–255
- Conversion:
  - direct, 50
  - indirect, 50
- Copolymers, 124, 247
- Corona treatment, 86, 326
- Crockmeter, 170
- Crosslink density, 134
- Crosslinkers, 257
- Crosslinking:
  - binders, 144
    - amino resins, 148
    - polyisocyanates, 145–147
  - mechanisms:
    - carbamate/melamine, 137
    - epoxy/acid, 138
    - silane, 139–140
    - melamine, 94
- Crystalline polymers, 246
- Crystallization, 126–127
- Cure:
  - chemistry, 105
  - conditions, 108
- Dehumidifying facilities, 337
- Die-lock, 66
- Directly paintable TPO, 85, 87–88

- Door applications, 253
- Dryers, high-temperature radiation, 340
- Durability test methodology, 153, 180
  
- Ecological considerations, 21
- Elastomers, 247
- Electrodischarge machining, 61
- Electromagnetic shielding (EMI), 51
- Electrostatic painting, 34, 110, 326, 341
- Encapsulation, 72
- End-of-life vehicles (ELVs), 269
- Energy conversion, 272–273
- Environmental etch resistance, 137, 143, 153, 170, 258–259
- Environmental regulations, 253–254
- Etch resistance:
  - clearcoat chemistry, 171
  - Jacksonville, 170
- Evaporation, 337
- Extraction procedure, 255
- Extrusion, 75
  - compression molding, 290
  
- Fillers, conductive, 13, 43–44, 249
- Film laminates, 268
- Flame retardants, 50, 248
  - spray, 266
  - treatment, 86, 324–325, 331, 351
- Flexibility tests, 168
- Flow cups, 335
- Fluorine treatment, 325, 327–328
- Forming processes, 75
  - drape forming, 76
  - pressure forming, 77
  - thermoforming, 55
    - twin-sheet, 77
  - vacuum forming, 76
    - plug-assisted, 77
- Fox equation, 134
- Fuel cell, 275
- Functionality, 131
  
- Gasoline resistance, 165
- Geometric mean model, 90
- Glass fibers, 50
  
- Glass transition temperature, 16, 66, 126, 153, 330
- Gouging, 165, 221, 236
  
- Harmonic mean model, 90
- Hazardous Air Pollutants (HAPs), 255
- Heat:
  - management, 51
  - stabilizers, 50
- Hiding, 264
- High-rotation electrostatic spray, 333
- Hindered amine light stabilizers, 180
- Homopolymer, 247
- Hydrogen bonding, 95
  
- Impact resistance, 168
- Injection molding, 64
- In-mold coatings, 268, 345
- Integrated Pollution Prevention and Control (IPPC), 322
- Interaction energy, 27
- Interdiffusion, 29
- Interfacial energy, 26, 88–91
- Interfacial tension, Young's equation, 23, 88
- Interiors:
  - acoustics, 300
  - barriers, 309
  - body and glazing seals, 315
  - coated fabrics, 309, 315
  - coextruded films, 314
  - door trim panels, 305–308
  - floor:
    - modules, 308
    - systems, 315
  - instrument panels, 301
  - molded-in effects, 313
  - patterns, 312
  - skins, 303, 312, 314
  - slush molding, 304–305
  - soft trim fabrication, 301–303
  - trim, 252
  - vacuum forming, 303
- Isocyanate, 258

- Legislation:
  - ELV, 300
  - PVC, 300
- Light microscope, 222, 234
- Liquid crystalline polymers, 246
- Low gloss coatings, 347
- Mar and scratch, 136, 150, 154, 221, 236, 256
- Mechanical properties, 171
  - after weathering, 173
  - coating T<sub>g</sub>, 172
  - stresses, 172
- Melamine crosslinking, 94
- Melting point, 126
- Melt strength, 55, 80
- Metallic flop, 332
- Migration, 161
- Miscibility, 88–89
- Modulus, 14
  - Young's, 18
- Mold-in color, 248, 283
  - accents, 283
  - metallics, 284
  - straight shades, 284
- Mold release agents, 30
- Molecular weight, 121–123, 130
  - number average, 123
  - weight average, 123
- MuCell, 253
- Municipal waste stream, 272
- Nanotechnology, 248
- New curing technology (NCT), 265
- New enamel technology (NET), 265
- No-flame primers, 324
- Nonpolluting coatings, 265
  - powder coatings, 266
  - supercritical CO<sub>2</sub>, 267–268
  - ultraviolet/electron beam, 267
- Nylon, 70
- Odor, 274
- Off-line coating, 318, 331
- Olefins, 82
- On-line coating, 318, 331, 346
- Orientation of metallic flake, 342
- Oxidation inhibitors, 248
- Paint adhesion, 85, 89, 95–97
- Painting processes:
  - application, 204
  - cleaning, 204
  - flash and cure, 205
- Paint removal, 271
- Paint supply systems, design of, 334
- Parison, 79–80
- Part economics, 58
  - capital costs, 60
  - variable costs, 61
- Phenolics, 48, 51
- Photooxidation, 180–181
  - durability, 135, 144
- Pigments, 50, 262
  - special-effect, 256, 264
- Plasma treatment, 86, 351
  - ambient pressure, 326
  - low pressure, 325
- Plastic classification:
  - thermoplastics, 244
  - thermosets, 244
- Plasticizers, 131
  - phthalate, 275
- Plastic/metal hybrids, 252
- Plastic processes:
  - blow molding, 52, 56, 59
  - compression-type, 52, 54, 71–73
  - extrusion, 52, 54
  - injection-type, 52
  - liquid injection molding, 53
  - pull-push processes, 54, 59, 74
  - push process, 52, 59
  - reaction injection molding (RIM), 53
  - rotating process, 55, 59
  - rotational molding, 52, 56
  - squeeze processes, 53, 59, 71–72, 77, 82
  - thermoforming, 52
- Plastics, 203
  - acrylonitrile/butadiene/styrene (ABS), 8
  - conductive modified, 41



- [Plastics]
  - conversion processes, 48
  - engineering, 4
  - interiors, 13
  - metallized, 7
  - outgassing, 159
  - polyamides (PA), 12
  - polycarbonate, 10
  - polyphenylene oxide (PPO), 12
  - polyurea, 9
  - reinforced reaction injection molding (RRIM), 189
  - sheet molding compound (SMC), 8, 189
  - solvent sensitive, 329
  - structural, 3
- Plastics by application:
  - behind the fascia, 250
  - exterior body panels, 251
  - under the hood, 249
- Pneumatic spray application, 339
- Poiseuille flow, 53
- Poisson's constant, 347
- Polar additives, 102
- Polycarbonate, coating of, 329
- Polydispersity, 124
- Polyester binders, 140, 141, 142
- Polyethylene, 5
- Polymerization, 48, 121
  - addition process, 49
  - chain growth, 122
  - condensation process, 49
  - degree of, 123
  - step growth, 122–123, 142
- Polymers, 121, 122
  - acrylonitrile/butadiene/styrene (ABS), 48
  - amorphous, 246
  - architecture, 129
  - bulk properties, 18
  - conductive modified, 35
  - crystalline, 246
  - engineering, 14
  - glass transition temperature, 19
  - liquid crystalline, 246
  - nylon 6/6, 49
- [Polymers]
  - phase diagrams, 17
  - polyamides, 13
  - poly(ethylene), 48
  - processing, 280–282
  - surface:
    - analysis, 24–25
    - properties, 18, 21
    - tension, 29
  - Polyolefins, 85, 89
  - Polypropylene, 5
  - Polyurethane:
    - binders, 142
    - thermosets, 5
  - Porosity, 346
  - Powder coating, 153
  - Pretreatment, 324
  - Primers, 189, 263
    - conductive, 345
    - electrically conductive, 328
  - Process capabilities, 57
  - Processing mechanics, 51
  - Process profiles, 63
  - Process technology:
    - coextrusion, 285
    - co-injection molding, 286
    - extrusion, 285
    - injection molding, 285
    - in-mold processing, 286
    - molding inserts, 287–290
  - Process window for waterborne base-coats, 338
- Radiation cured coatings, 149
- Reaction injection molding (RIM), 69, 71, 85, 161
  - reinforced (RRIM), 69–70, 251, 317
  - structural (SRIM), 70
- Reactive diluents, 131, 262
- Recyclability, 86, 87
  - design for, 270
  - dismantlability, 270
- Recycling, 243
  - criteria, 269
- Reinforced reaction injection molding (RRIM), 69–70, 251, 317

- Reinforcing fibers, 249
- Replenishing tank, 343
- Resin transfer molding, 72–74
- Rheology:
  - characteristics, 336
  - control agents, 262
- Rotational molding, 81–82
  
- Scratch, 169
- Segregation of molded-in color, 271, 272
- Sheet molding compound (SMC), 54, 72, 250–251, 269, 320, 345–346, 351
  - gassing, 233
- Silane, 259
- Silicones, 161
- Skins, 253
- Slido, 166–167
- Soft feel, 252
- Soft touch, 143, 347–350
- Solvency, 130
- Spray booths, 318
- Stabilizers, 153
  - hindered amine light, 154, 180, 344
  - thermal, 248
  - ultraviolet absorbers, 154, 190–191, 248, 344
- Stereo regularity, 322
- Stiffness, 107
- Stone chipping, 221
- Stress levels, 63
- Structural foam molding, 67
- Structural reaction injection molding (SRIM), 70
- Substrate:
  - adhesion, 184
  - appearance, 182
  - chipping, 185
  - durability, 182
  - etch and chemical resistance, 187
  - flexibility, 185
  - gasoline resistance, 184
  - gouging, 184
  - impact resistance, 185
  - [Substrate]
    - scratch and mar, 186
    - thin-walled TPO, 186
- Superacids, 150
- Surface appearance, class A, 75, 80
- Surface contamination, 29
- Surface defects:
  - bondline readout, 209–210
  - color, 218
  - convection flow, 210
  - craters, 206–207
  - dewetting, 207–208
  - dirt, 216–218
  - fiber read-through, 209
  - flow related, 215–216
  - gassing, 214
  - micropopping, 214
  - picture framing, 210
  - surface tension driven, 205
  - telegraphing, 208–209, 232
  - volatile related, 213
- Surface energy, 87, 89, 96, 99
- Surface functionalization, 33
- Surface morphology, 30
- Surface tension, 26, 324, 342
  - gradients, 232
  - liquids, 89
  - polymers, 29
- Surface treatment, 31–32
  - plasma, 31
  
- Taber abrader, 117
  - testing, 170
- TA Luft regulation, 321
- Thermoform coextruded sheets, 290
- Thermogravimetric analysis, 232
- Thermoplastic olefins (TPO), 5, 85–87, 89, 91, 186, 317
  - coating process, 323
- Thermoplastics, 50–51, 78, 80, 128
- Thermosets, 50–51, 73
- Thin-walled molding, 322
- Tie-layer, 86–87
- Tooling, 66
- Toxicity characteristic, 255
- Transfer efficiency, 34, 36, 39, 110

- Ultraviolet (UV):
  - absorbers, 180, 220, 282
  - light treatment, 86
  - resistance, 110–111
  - stabilizers, 50
- Uretdiones, 147
- Urethanes, 48, 70, 85
  - crosslinking, 94
- Viscosity, 128, 342
  - measurement, 233
- Volatile organic compound (VOC), 86–87, 254, 263, 265, 321
- Waterborne coatings, 152
- Wave scan, 321
- Weak boundary layers, 30
- Weathering:
  - accelerated, 176
- [Weathering]
  - carbon arc, 179
  - durability, 174
  - emmaqua, 179
  - natural, 173
  - quartz ultraviolet (QUV), 178–179
  - xenon arc, 176–178
- Wetting, 211
  - adhesion, 228
  - contact angles, 225, 229
  - critical surface tensions, 223
  - dewetting tests, 230
  - solid surface tensions, 226–228
  - tests, 223
  - Zisman plots, 224, 230
- Work of adhesion, 89–90
- Young's equation, 23, 88